

**CONTROLTM
TECHNIQUES**

Authorized Distributor
ORIENTAL DM SDN BHD

HIGH PERFORMANCE VECTOR CONTROL DRIVE

NE200 & NE300



POWER RANGE
0.4KW ~ 900KW
0 ~ 550Hz

Nidec
All for dreams

CONTROLTM TECHNIQUES

DRIVE SPECIALISTS SINCE 1973

Drives: they're what we do. Whether you are designing a new machine or installing a replacement, we know how quick delivery and an easy set up, with the confidence that your drives going to keep on performing with accurate control.

So leave it to the specialists. We've dedicated ourselves to designing and manufacturing variable speed drives since 1973. This means quick set up, high reliability, maximum motor control and fast, efficient service.



1,000+
OEM
CUSTOMERS



5M+
INSTALLED
DRIVES



1,000+
EMPLOYEES
WORLDWIDE



70
COUNTRIES

Control Techniques over 40 years drive industry expertise provides high performance, high-reliability products for customers. We are dedicated to industrial automation development. Product development team in the UK headquarter to 45 automation centers worldwide provide an overall solution for customers. Control Techniques is the technical leader in the motion control field.

In China, Control Techniques has three subsidiaries they are Beijing Subsidiary, Shanghai subsidiary, and Shenzhen Guangming subsidiary. Representative offices and service network cover all provincial capitals national wide and radiate adjacent areas. We provide professional, comprehensive and quick response integrated solution for customers.





Global reach, local support

Highly experienced, locally based Application Engineers design and support drive technology to provide maximum value, wherever you are in the world.

Outstanding performance

The outstanding performance of our drives is the fruit of over 45 years of engineering experience in drive design.



Technology you can rely on

Robust design and the highest build quality ensure the enduring reliability of the millions of drives installed around the world.



Open design architecture

Based on open design architecture, our drives integrate with all primary communication protocols.



Embedded intelligence

Precision motor control is combined with the highest embedded intelligence, ensuring maximum productivity and efficiency of your machinery.

Outstanding control performance

- Outstanding software control platform with unique vector control algorithm
- Renesas 32 bit high speed motor control DSP
- Authentic current vector control: torque current and field current decoupling control
- Advanced vector control algorithm: induction motor and PM motor control
- Three control modes: Vector control without PG, Vector control with PG and V/F control
- The real hardware speed tracking function, more stable and reliable than the software tracking function
- Dynamic current torque control, quickly response to load variation
- Accelerating current suppression, unique current algorithm avoid machine trip due to high startup current without impacting startup torque
- Superior torque performance at low frequency, open loop vector control 150% torque output at 0.5Hz, satisfied low frequency high torque applications such as machine tool, crane and hoist industry.
- Superior overload performance: 180% current for 20s
- High precision speed control, enable high accurate synchronous control

Powerful function

- Multiple frequency setup function
- Open-loop / close-loop torque control function, torque control mode/ speed control mode online switching
- PID function provide two groups PI parameters, PID output range is settable, supporting sleep mode
- V/F separate control function in V/F control mode
- Tension control drive enable automatic rolling diameter calculation pre-setup function
- Automatic load balance droop control function
- Fixed length control function
- RS-485 communication port supporting MODBUS-RTU communication protocol for multi drive synchronization.
- Various extension cards are optional for flexible applications.
- Automatic energy saving function, power off automatically restart function, and parameter cloning through keypad.
- Parameter backup function and recovery through terminals.
- Rich protection and supervision functions.

Superior adaptability

- Unique IGBT drive circuit, more reliable operation for power components
- Phase-to-phase Short-circuit protection for all product, grounding protection for >18.5KW products, adaptable for harsh environment
- Wide working voltage range: 304VAC-456VAC
- German conformal coating material
- Optimize EMC design, immunity for high interference environment
- 100% incoming inspection
- Automatic PCB and drive tests
- High temperature aging test for PCB and drives.

Novel design

- Independent ventilation design for all whole series products, ventilation channel and electrical components are separated, reduce the failure rates for electrical parts.
- Compact design, based on thermal simulation and design to reduce product size, the size of products is around 70% of main stream brands at the same power rating.
- Graphic keypad to satisfy majority operation behavior
- Control panel standard RJ45 port, enhanced communication anti-interference ability, convenient to extension.
- Aluminum zinc plate and painting protection ensure the grounding protection, shielding performance and products' rot resistance.
- DC fan design for whole series products, reduce cooling system failure rate leading by AC fan breakdown

*Please consult our company for customized drive model detail.



Product Model description

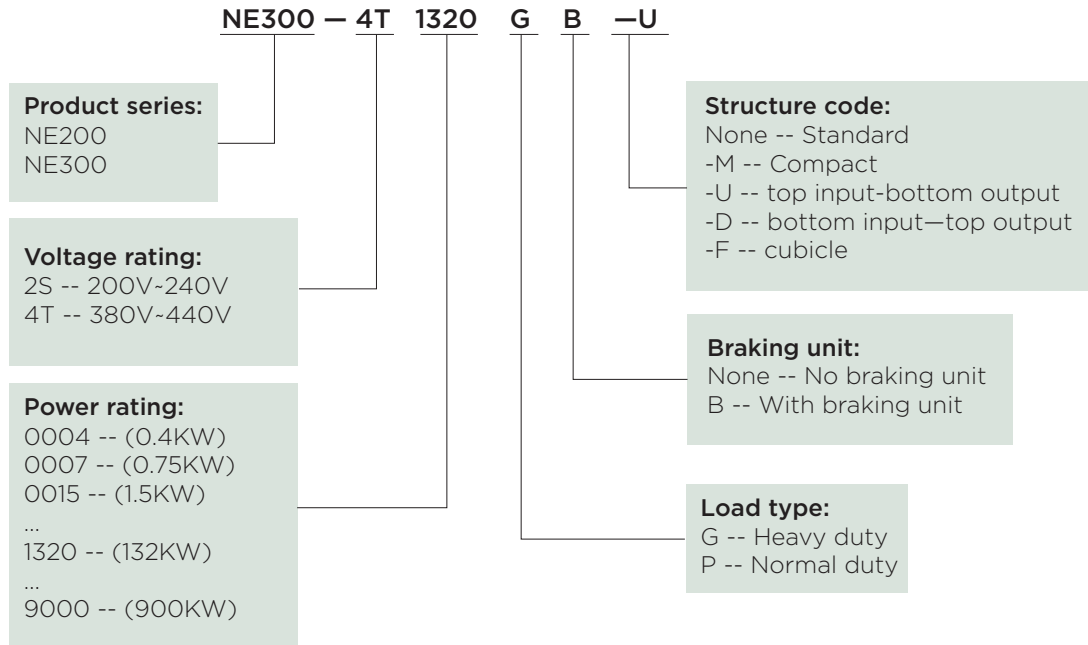

Note: Some types of NE200 and NE300 products are dual rated e.g. NE300-4T0185G/0220PB

NE200 series drive

Main circuit input / output terminals

NE200 have two types of main circuit terminals, please check your drive model with tables below :

1. NE200-2S0004GB, NE200-2S0007GB, NE200-2S0015GB, NE200-4T0007G/0015PB, NE200-4T0015G/0022PB

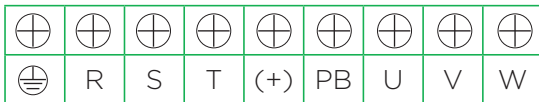

Terminal symbol	Terminal type and description
	Grounding terminal PE
R, S	1- phase AC input terminals
R, S, T	3-phase AC input terminals
(+), PB	Terminals reserved for braking resistor
U, V, W	3-phase AC output terminals

2. NE200-2S0022GB, NE200-4T0022G/0040PB, NE200-4T0040G/0055PB

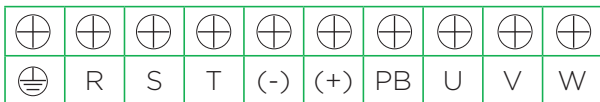

Terminal symbol	Terminal type and description
	Grounding terminal PE
R, S	1- phase AC input terminals
R, S, T	3-phase AC input terminals
(+), (-)	DC bus negative and positive terminals for common DC bus input
(+), PB	Terminals reserved for braking resistor
U, V, W	3-phase AC output terminals

NE200 series drive

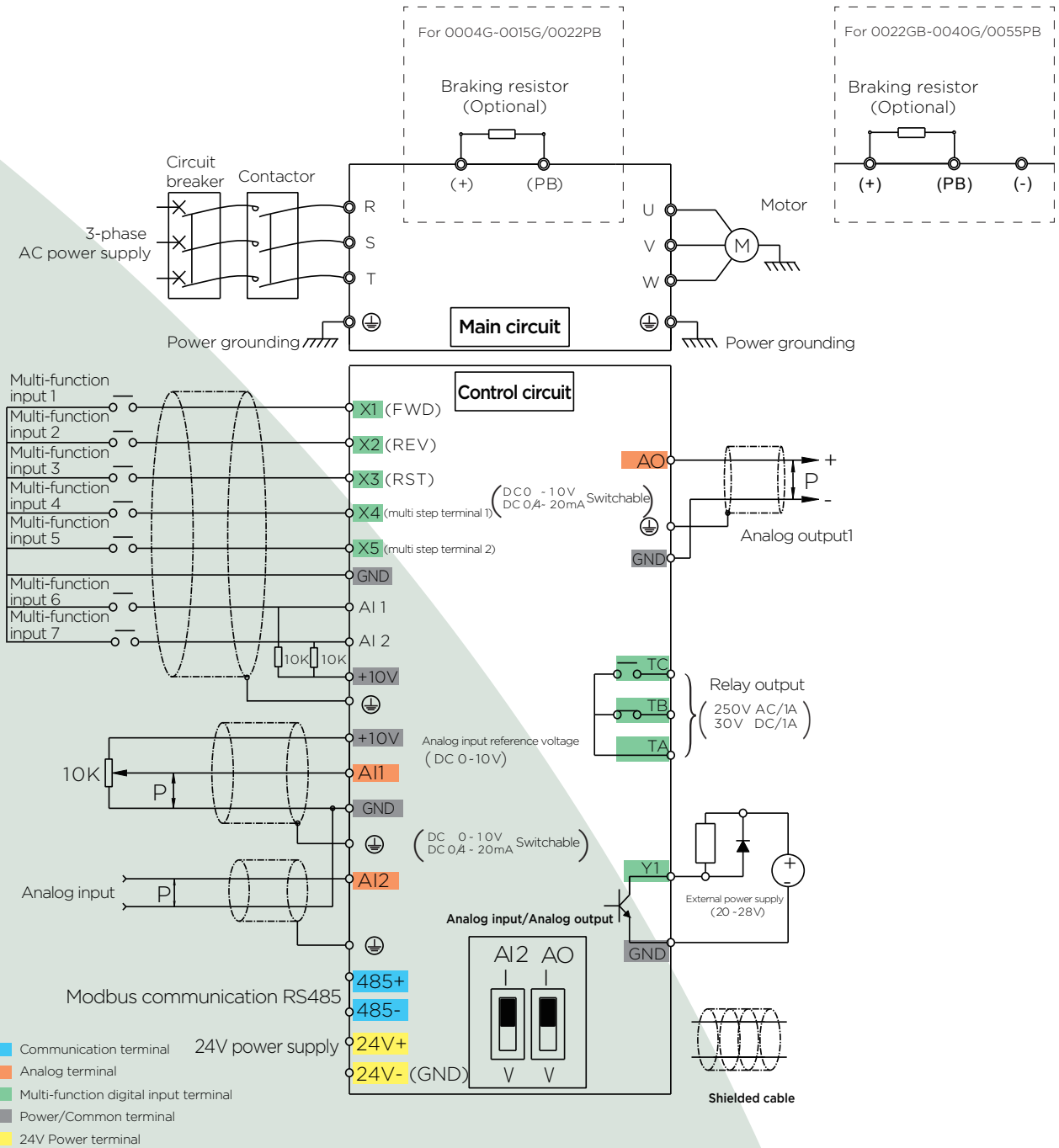

Terminal wiring

Note 1: NE200 equip braking unit
 Note 2: X1-X5 voltage range: 0-12V

NE200 series drive technical specifications:

Input	Rated power/ frequency	NE200-2Sxxxx: 1-phase 200V - 240V; 50Hz/60Hz		
		NE200-4Txxxx: 3-phase 380V - 440V; 50Hz/60Hz		
Voltage range		NE200-2Sxxxx: 176V - 264V; Voltage unbalance degree: $\leq 3\%$; permissible frequency fluctuation: $\pm 5\%$		
		NE200-4Txxxx: 304V - 456V; Voltage unbalance degree: $\leq 3\%$; permissible frequency fluctuation: $\pm 5\%$		
Output	Voltage range	NE200-2Sxxxx: 0-200V/440V; NE200-4Txxxx: 0-380V/440V		
	Overload capacity	Type G: 150% rated current 1min, 180% rated current 20s		
		Type P: 120% rated current 1min, 150% rated current 1s		
Control features	Control mode	Vector control with PG(VC)	Vector control without PG(SVC)	V/F control
	Startup torque	----	0.5Hz 150%	1.5Hz 150%
	Speed adjustable range	----	1:100	1:50
	Speed stabilization precision	----	$\pm 0.2\%$	$\pm 0.5\%$
	Torque control	----	Yes	N/A
	Torque precision	----	$\pm 10\%$	----
	Torque response time	----	<20ms	----
Product functions	Key functions	Torque/speed control mode switching, Multi-function input/ output terminals, under voltage regulation, AC operation grounding switching, torque limit, multi step operation, slip compensation, PID regulation, simple PLC, current control, manual/ automatic torque boost, current limit, AVR function		
	Frequency setup	Keypad, terminal Up/Down, Communication, Analog input AI1/AI2		
	Output frequency	0.00-550.0Hz		
	Startup frequency	0.00-60.00Hz		
	Acc/Dec time	0.01-3600.0s		
	Dynamic braking	400V drive: braking unit action voltage: 650 - 750V;		
		200V drive: braking unit action voltage: 360 - 390V;		
	DC injection braking	DC braking activation frequency: 0.00 - 550.0Hz		
DC braking current: G type 0.0 - 100.0%; P type 0.0 - 80.0%				
DC braking time: 0.0 - 30.0s; Quick DC brake activation without lag time				
Magnetic flux braking	Fast deceleration through adding motor magnetic flux			
Unique functions	Parameter cloning	Parameter upload, download. User can forbid the overwriting of the uploaded parameters.		
Protection function	Power undervoltage/overvoltage protection, overcurrent protection, IGBT protection, heatsink overheat protection, drive overload protection, motor overload protection, External devices faults protection, output phase-to-phase short-circuit protection, Abnormal power failure in running, power supply trip, output phase loss, EEPROM trip, Analog input trip, communication trip, version compatibility trip, cloning trip, hardware overload protection			
Environment	Application environment	Vertical installation in well ventilated cabinet. Horizontal or other installation are forbidden. The cooling medium is air. Free from direct sunlight, dust, corrosive gas, combustible gas, oil mist, steam, and water drop.		
	Ambient temperature	-10-+40°C, deration is required from 40 to 50°C, rated output current decreasing 1% per 1°C temperature higher		
	Humidity	5-95% without condensation		
	Altitude	0-2000m, deration is required for more than 1000 meters, at rated output current decreasing 1% per 100m higher		
	Vibration	3.5mm, 2-9Hz; 10 m/s ² , 9-200Hz; 15 m/s ² , 200-500Hz		
	Storage temperature	-40-+70°C		
Structure	Protection level	IP20		
	Cooling	Fan air cooling		

NE300 series drive

Main circuit input / output terminals

NE300 have five types of main circuit terminals, check your drive model with tables below :

1, NE300-4T0015G/0022PB - NE300-4T0220G/0300PB



Terminal symbol	Terminal type and description
	Grounding terminal PE
R, S, T	3-phase AC input terminals
(-), (+)	DC bus negative and positive terminals for common DC bus input
(+), PB	Terminals reserved for braking resistor
U, V, W	3-phase AC output terminal

2, NE300-4T0300G/0370P - NE300-4T1100G/1320P

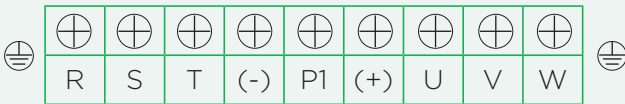

Terminal symbol	Terminal type and description
	Grounding terminal PE
R, S, T	3-phase AC input terminals
(-), (+)	DC bus negative and positive terminals for common DC bus input
P1, (+)	Reserved for DC reactor connecting terminals; Short circuited with copper plate as factory setting
U, V, W	3-phase AC output terminals

3, NE300-4T1320G/1600PB-U - NE300-4T2500G/2800PB-U

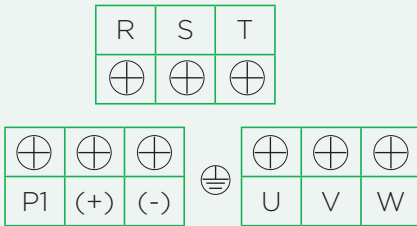

Terminal symbol	Terminal type and description
	Grounding terminal PE
R, S, T	3-phase AC input terminals
(-), (+)	DC bus negative and positive terminals for common DC bus input
P1, (+)	Reserved for DC reactor connecting terminals; Short circuited with copper plate as factory setting
U, V, W	3-phase AC output terminals

4, NE300-4T1320G/1600PB-D - NE300-4T2500G/2800PB-D

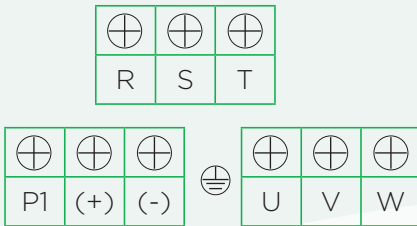

Terminal symbol	Terminal type and description
	Grounding terminal PE
R, S, T	3-phase AC input terminals
(-), (+)	DC bus negative and positive terminals, common DC bus input
P1, (+)	DC reactor reserved terminals, default connected by copper busbar
U, V, W	3-phase AC output terminals

5, NE300-4T1600G/1850PB -F- NE300-4T8000G/9000PB-F

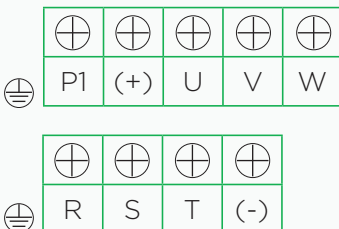

Terminal symbol	Terminal type and description
	Grounding terminal PE
R, S, T	3-phase AC input terminals
(-), (+)	DC bus negative and positive terminals for common DC bus input
P1, (+)	Reserved for DC reactor connecting terminals; Short circuited with copper plate as factory setting
U, V, W	3-phase AC output terminals

NE300 series drive

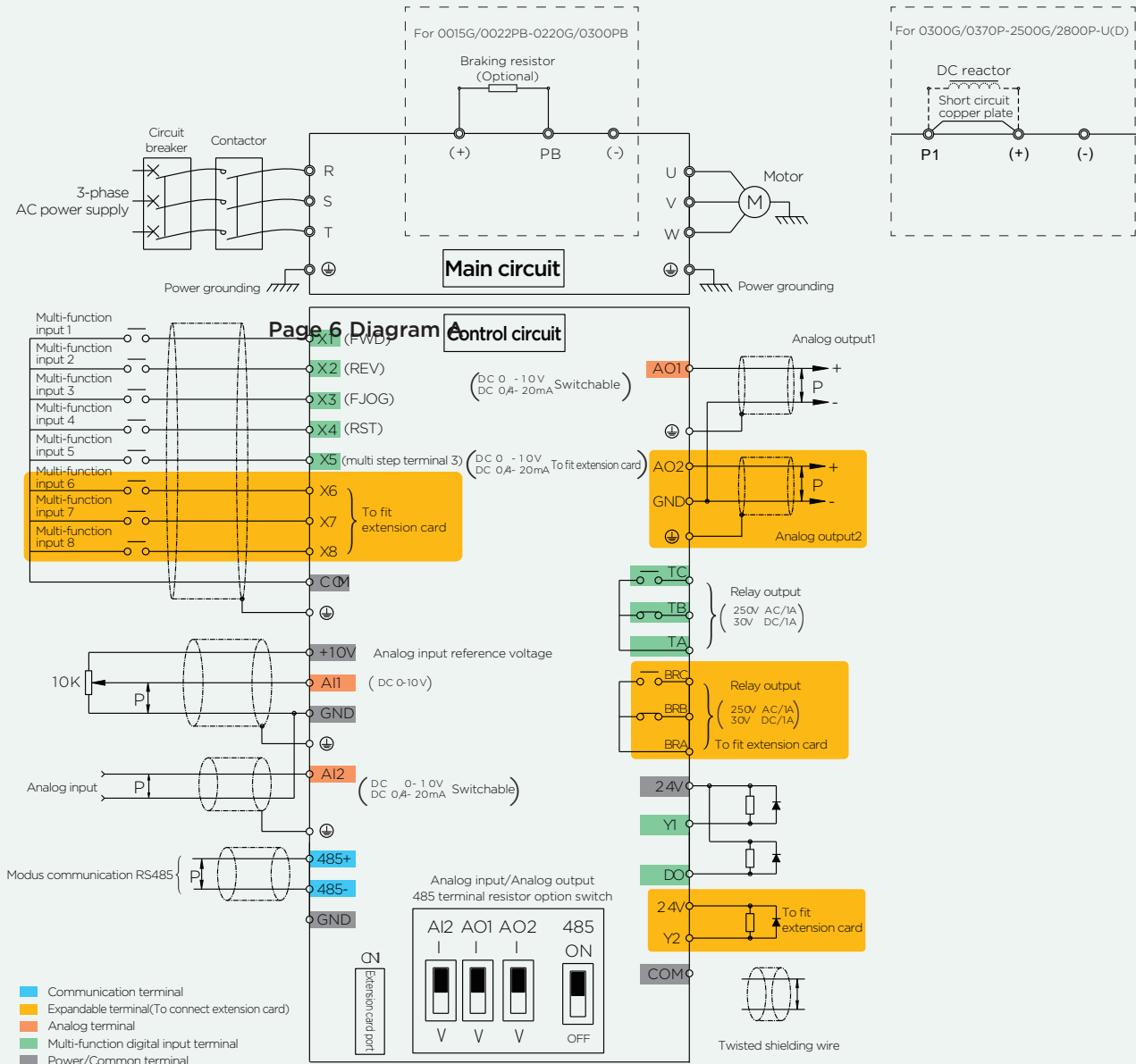

Terminal connection

Note 1: NE300-4T0015G/0022PB ~ NE300-4T0220G/0300PB equip braking unit

Note 2: NE300-4T1600G/1850P-F ~ NE300-4T9000G-F equip DC reactor

NE300 series drive technical specifications:

Input	Rated power/frequency	3-phase 380V - 440V; 50Hz/60Hz		
	Voltage range	304V - 456V; Voltage unbalance degree: $\leq 3\%$; Permissible frequency fluctuation: $\pm 5\%$		
Output	Voltage range	0-380V/440V		
	Overload capacity	Type G: 150% rated current 1min, 180% rated current 20s Type P: 120% rated current for 1min, 150% rated current for 1s		
Control features	Control mode	Vector control with PG(VC)	Vector control without PG(SVC)	V/F control
	Startup torque	0.00Hz 180%	0.5Hz 150%	1.5Hz 150%
	Speed adjust range	1:1000	1:100	1:50
	Speed stabilization precision	$\pm 0.02\%$	$\pm 0.2\%$	$\pm 0.5\%$
	Torque control	Yes	Yes	N/A
	Torque precision	$\pm 5\%$	$\pm 10\%$	----
	Torque response time	<10ms	<20ms	----
Product functions	Key functions	Torque/speed control switching, Multi-function input/ output terminals, under voltage regulation, AC operation grounding switching, flying start, torque limit, multi speed operation, autotune, S curve Acc/Dec, slip compensation, PID regulation, simple PLC, fix length control, droop control, current control, manual/ automatic torque increase, current limit, AVR function		
	Frequency setup	Keypad, terminal Up/Down, communication, Analog input AI1/AI2, Terminal pulse input X4,X5		
	Output frequency	0.00-550.0Hz		
	Startup frequency	0.00-60.00Hz		
	Acc/Dec time	0.1-3600s		
	Dynamic braking	400V drive: braking unit voltage: 650 - 750V;		
		200V drive: braking unit voltage: 360 - 390V;		
	DC injection braking	DC braking activation: 0.00 - 550.0Hz		
DC braking current: G type 0.0 - 100.0%; P type 0.0 - 80.0%				
Magnetic flux braking	DC braking time: 0.0 - 30.0s; Quick DC brake activation without lag time			
	Fast deceleration through adding motor magnetic flux			
Unique functions	Parameter cloning	Parameter upload, download. User can forbid the overwriting of the uploaded parameters.		
	Keypad	LED keypad as standard.		
	Common DC bus	Common DC bus for multiple drives power supply		
	Independent air duct	Independent air duct design for whole series product		
	Extension card	IO extension card, injection molding machine connecting card etc.		
Power-up detection	Automatic detection of internal and external circuits when power-up			
Protection function	Power undervoltage/overvoltage protection, overcurrent protection, autotune trip, IGBT protection, heatsink overheat protection, drive overload protection, motor overload protection, external device false protection, output to ground short-circuit protection, abnormal power failure in running, power supply abnormal, output phase loss, EEPROM trip, relay contact error, temperature sampling abnormal, encoder off-line, analog input trip, communication trip, version compatibility trip, cloning trip, extension card connection trip, hardware overload protection			
Efficiency	Operation at rated power: 7.5kW or below $\geq 93\%$; 11kW-45kW $\geq 95\%$; 55kW or above $\geq 98\%$			
Environment	Application environment	Vertical installation in well ventilated cabinet. Horizontal or other installation are forbidden. The cooling medium is air. Free from direct sunlight, dust, corrosive gas, combustible gas, oil mist, steam, and water drop.		
	Ambient temperature	-10°C-+40°C, deration is required from 40 to 50°C, rated output current decreasing 1% per 1 °C temperature higher		
	Humidity	5-95% without condensation		
	Altitude	0-2000m, deration is required for more than 1000 meters, at rated output current decreasing 1% per 100m higher		
	Vibration	3.5mm, 2-9Hz; 10 m/s ² , 9-200Hz; 15 m/s ² , 200-500Hz		
Storage temperature	-40-+70°C			
Structure	Protection level	IP20		
	Cooling	Fan force cooling		

*Please consult our company for vector control drive with PG model selection.

Compressor industry solution

Solution features

- High performance speed sensor-less vector control technology. High efficiency low energy consuming, energy saving rate can reach max. 50%. Special integrated design to adapt with air compressor operation characteristics, completely change the traditional mode of "general purpose drive + special controller";
- Vector control speed stabilization precision is 0.2%, quickly and accurately response to pressure variation, close-loop constant air supply precision can reach $\pm 0.01\text{MPa}$;
- High startup torque can fully support compressor fully loading starting up.
- Superior overload capacity, wider speed control range, can fully satisfied air system temporary overload requirement;
- Superior software and hardware protection ensures compressor system reliability and stability.
- Steady starting and operating, no impact for power grid, low wear, long life, and low noise.



Solution advantages

- Constant pressure control: Inbuilt high efficiency PID algorithm, quick response to air demand;
- Frequency conversion/power frequency switching: ensure non-stopping air supply;
- Intelligent system: Timing control, Automatic sleep, Automatic wake-up and other functions
- Cascade control: multiple air compressors supply gas at the same time, automatic allocation of working hours and output power
- User interface: optional text display keypad and touch screen graphic screen.

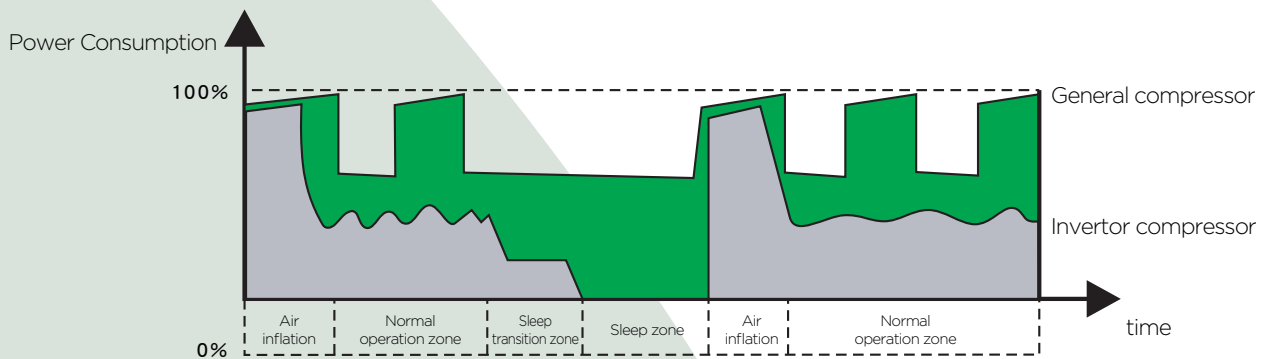

Grey: Inverter compressor power consumption curve
Green: Energy saving margin, energy saving rate 30%-50%

Machine tool industry solution

Solution features

- Variable V/F and vector control modes are applicable for various machine tools, e.g.: lathe, miller, driller, grinder, and carving machine, etc.;
- Unique digital signal tiny pulse harmonic control technology ensures super quiet operation;
- Variable speed command channels: current/ voltage analog input, pulse input, communication input.

Solution advantages

- High torque at low frequency: Reduce 90% during cutting compared with open-loop control, satisfied machine tools' principle axis low speed heavy cutting requirement;
- High speed stabilization precision: speed stabilization precision is 0.02% of rated speed, speed fluctuation is small;
- Reliable operation control: inbuilt torque limitation and over voltage protection avoid trip;
- Quick dynamic response: dynamic torque response time < 20ms, small speed fluctuation during instant upload or unload;
- Superior overload capacity: 150% rated current 1min, 200% rated current 0.5s.



Torque motor substitution solution

Solution features

- Significant energy saving effect and reliable operation, without extra heat loss, extend system working life;
- No requirement for extra encoder, saving cost and completely immune external interference;
- Retrofit system will not change original operation behavior;
- Steady torque output, reliable operation.

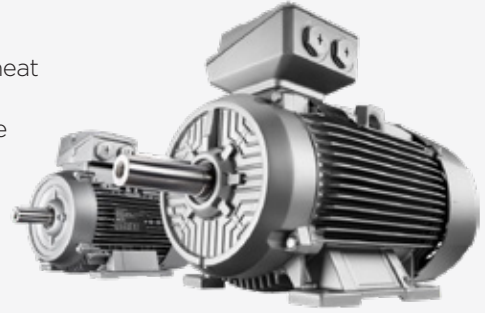

Solution advantages

- Superior overload capacity: 150% rated current 1min, 200% rated current 0.5s;
- High torque at low frequency: 180% rated torque at 0.5Hz;
- Reliable operation control: inbuilt torque limitation and overvoltage adjustment, avoid trip;
- Quick dynamic response: dynamic torque response time<20mS, small speed fluctuation during instant upload or unload;
- Synchronized winding: high performance open-loop vector control, ensure post stage winding speed follows the forstage winding at any time.
- Full lap start/stop: drive startup torque high and stable even under full lap condition with highest inertia, automatic torque output compensation according to roll diameter variation;
- Whole speed range operation: winding motor can stably operate at extra low speed(0.5Hz) and relatively high speed, even in motor constant power zone.

NE200 dimensions (Unit: mm)

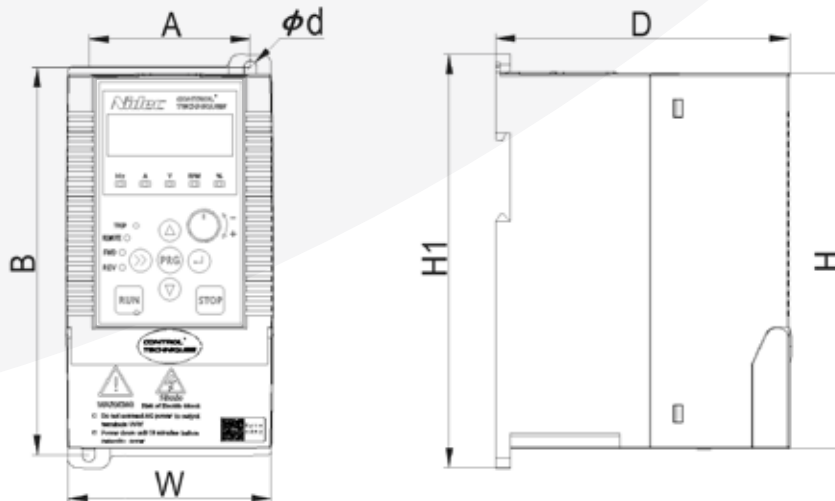

NE200 order code and dimension:

Drive model G: Heavy Duty P: Normal Duty	Order code	Rated output current (A)	Motor power (KW)	H Height (mm)	W Width (mm)	D Depth (mm)	H1 Height (mm)	A (mm)	B (mm)	d (mm)
NE200-2S0004GB	01189010_E	2.5	0.4	150	83	120	166	65	153	5
NE200-2S0007GB	01189011_E	4.5	0.75							
NE200-2S0015GB	01189012_E	7	1.5							
NE200-4T0007G/O15PB	01189013_E	2.5/4.0	0.75/1.5							
NE200-4T0015G/O022PB	01189014_E	4.0/6.0	1.5/2.2							
NE200-4T0022GB-M	01189015_E	6.0	2.2							
NE200-2S0022GB	01189016_E	10	2.2	200	120	140	215	98	202	5
NE200-4T0022G/O040PB	01189018_E	6.0/9.0	2.2/4.0							
NE200-4T0040G/O055PB	01189019_E	9.0/13	4.0/5.5							

NE300 dimensions (Unit: mm)

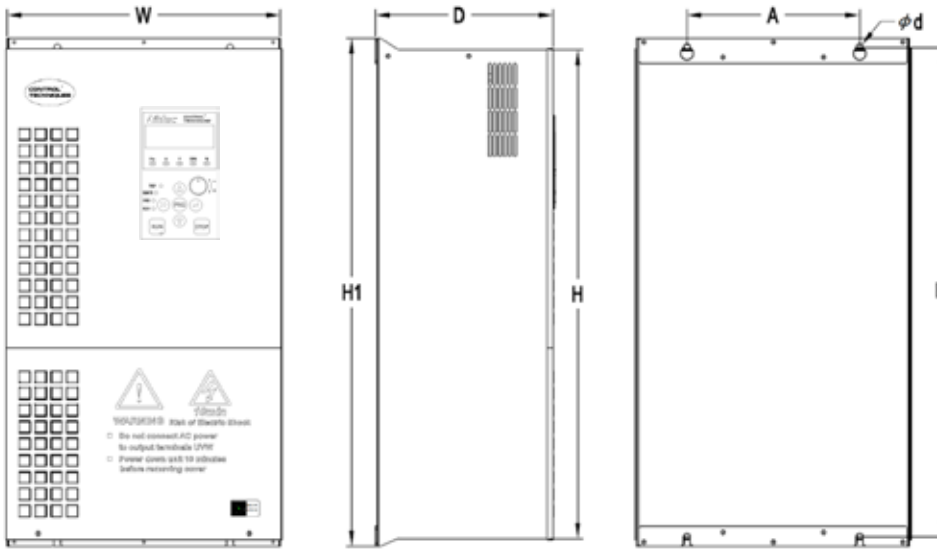

NE300 order code and dimension:

Drive model G: Heavy Duty P: Normal Duty	Order code	Rated output current (A)	Motor power (KW)	H Height (mm)	W Width (mm)	D Depth (mm)	H1 Height (mm)	A (mm)	B (mm)	d (mm)
NE300-4T0015G/0022PB	01189020_E	4.0/6.0	1.5/2.2	210	133	180	238	108	225	7
NE300-4T0022G/0040PB	01189021_E	6.0/9.0	2.2/4.0							
NE300-4T0040G/0055PB	01189022_E	9.0/13	4.0/5.5							
NE300-4T0055G/0075PB	01189023_E	13/17	5.5/7.5	258	155	180	285	120	270	7
NE300-4T0075G/0110PB	01189024_E	17/25	7.5/11							
NE300-4T0110G/0150PB	01189025_E	25/32	11/15							
NE300-4T0150G/0185PB	01189027_E	32/37	15/18.5	308	192	186	340	150	323	7
NE300-4T0185G/0220PB	01189028_E	37/45	18.5/22							
NE300-4T0220G/0300PB	01189029_E	45/60	22/30							
NE300-4T0300G/0370P	01189032_E	60/75	30/37	425	270	200	450	200	430	7
NE300-4T0370G/0450P	01189033_E	75/90	37/45							
NE300-4T0450G/0550P	01189035_E	90/110	45/55	535	320	248	560	240	540	9
NE300-4T0550G/0750P	01189036_E	110/150	55/75							
NE300-4T0750G/0900P	01189037_E	150/176	75/90	640	380	248	665	240	640	9
NE300-4T0900G/1100P	01189038_E	176/210	90/110							
NE300-4T1100G/1320P	01189039_E	210/250	110/132							

* Specialized drive and Vector control with PG card (VC) model selection, please consult our company for detail.

NE300 order code and dimension:

Drive model G: Heavy Duty P: Normal Duty	Order code	Rated output current (A)	Motor power (KW)	H Height (mm)	W Width (mm)	D Depth (mm)	H1 Height (mm)	A (mm)	B (mm)	d (mm)
NE300-4T1320G/1600P-U	01189040_E	250/300	132/160	710	465	355	750	380	719	11
NE300-4T1320G/1600P-D	01189041_E	250/300	132/160							
NE300-4T1600G/1850P-U	01189042_E	300/340	160/185							
NE300-4T1600G/1850P-D	01189043_E	300/340	160/185							
NE300-4T1850G/2000P-U	01189044_E	340/380	185/200	859	550	385	900	440	868	11
NE300-4T1850G/2000P-D	01189045_E	340/380	185/200							
NE300-4T2000G/2200P-U	01189046_E	380/420	200/220							
NE300-4T2000G/2200P-D	01189047_E	380/420	200/220							
NE300-4T2200G/2500P-U	01189048_E	420/470	220/250							
NE300-4T2200G/2500P-D	01189049_E	420/470	220/250							
NE300-4T2500G/2800P-U	01189050_E	470/540	250/280							
NE300-4T2500G/2800P-D	01189051_E	470/540	250/280							
NE300-4T1600G/1850P-F	01189052_E	300/340	160/185	1400	400	402	1455	460	1270	13
NE300-4T1850G/2000P-F	01189053_E	340/380	185/200							
NE300-4T2000G/2200P-F	01189054_E	380/420	200/220							
NE300-4T2200G/2500P-F	01189055_E	420/470	220/250							
NE300-4T2500G/2800P-F	01189056_E	470/540	250/280	1600	505	420	1655	560	1460	13
NE300-4T2800G/3150P-F	01189057_E	540/600	280/315							
NE300-4T3150G/3550P-F	01189058_E	600/660	315/355							
NE300-4T3550G/4000P-F	01189059_E	660/730	355/400	1800	780	500	1870	840	1630	13
NE300-4T4000G/4500P-F	01189060_E	730/840	400/450							
NE300-4T4500G/5000P-F	01189061_E	840/900	450/500							
NE300-4T5000G/5600P-F	01189062_E	900/950	500/560							
NE300-4T5600G/6300P-F	01189063_E	950/1160	560/630	1800	780	500	1870	-	-	-
NE300-4T6300G/7100P-F	01189064_E	1160/1300	630/710							
NE300-4T7100G/8000P-F	01189065_E	1300/1460	710/800							
NE300-4T8000G/9000P-F	01189066_E	1460/1640	800/900							
NE300-4T9000G-F	01189067_E	1640	900							

- *-F freestanding drive with DC reactor inbuilt;
- *-U upside input downside output type wall mounting structure;
- *-D downside input upside output type wall mounting structure.

* Specialized drive and Vector control with PG card model selection, please consult our company for detail.

Keypad

	Order code	Specification	Drive model
LED Keypad	NEF-LED01	Standard	NE200/NE300
Keypad holder	NEF-KB01	Optional	NE200/NE300
Keypad cable	NEF-CB0020	2m(Optional)	NE200/NE300
Keypad cable	NEF-CB0030	3m(Optional)	NE200/NE300



NEF-LED01



NEF-KB01

LED keypad display and keypad holder dimensions: (mm)

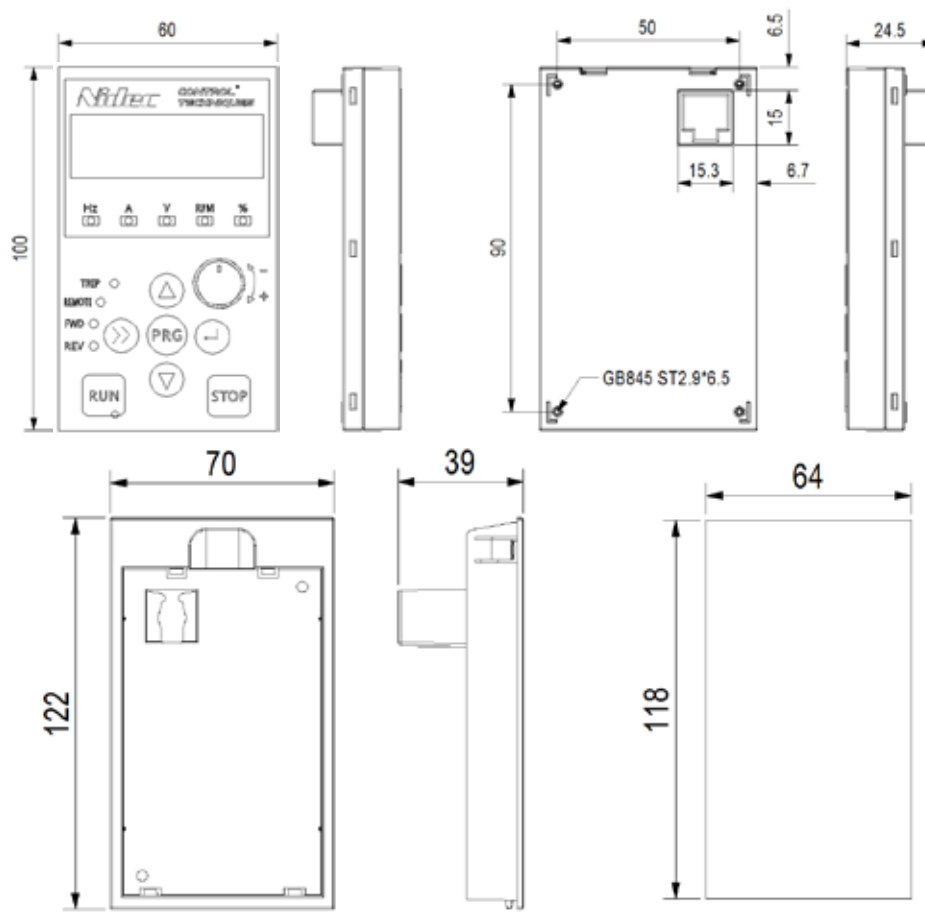

Braking resistor

NE200 braking resistor

Drive model	Braking unit	Braking resistor			Braking torque %
		Braking resistor	Quantity		
NE200-2S0004GB	Inbuilt as standard	100W	200Ω	1	135
NE200-2S0007GB		200W	150Ω	1	135
NE200-2S0015GB		400W	100Ω	1	125
NE200-2S0022GB		300W	70Ω	1	125
NE200-4T0007G/0015PB		400W	300Ω	1	135
NE200-4T0015G/0022PB		400W	300Ω	1	135
NE200-4T0022GB-M		500W	200Ω	1	135
NE200-4T0022G/0040PB		500W	200Ω	1	135
NE200-4T0040G/0055PB		500W	200Ω	1	135

NE300 braking resistor

Drive model	Braking unit	Braking resistor			Braking torque %
		Braking resistor	Quantity		
NE300-4T0015G/0022PB	Inbuilt as standard	400W	300Ω	1	135
NE300-4T0022G/0040PB		500W	200Ω	1	135
NE300-4T0040G/0055PB		500W	200Ω	1	135
NE300-4T0055G/0075PB		500W	100Ω	1	135
NE300-4T0075G/0110PB		800W	75Ω	1	130
NE300-4T0110G/0150PB		1000W	50Ω	1	135
NE300-4T0150G/0185PB		1500W	40Ω	1	125
NE300-4T0185G/0220PB		4000W	30Ω	1	125
NE300-4T0220G/0300PB		4000W	30Ω	1	125
NE300-4T0300G/0370P	Need external	6000W	20Ω	1	125
NE300-4T0370G/0450P		9000W	16Ω	1	125
NE300-4T0450G/0550P		9000W	13.6Ω	1	125
NE300-4T0550G/0750P		6000W	20Ω	2	135
NE300-4T0750G/0900P		9000W	13.6Ω	2	145
NE300-4T0900G/1100P		6000W	20Ω	3	130
NE300-4T1100G/1320P		6000W	20Ω	3	130
NE300-4T1320G/1600P-U		6000W	20Ω	4	130
NE300-4T1320G/1600P-D		6000W	20Ω	4	130
NE300-4T1600G/1850P-U		9000W	13.6Ω	4	130
NE300-4T1600G/1850P-D		9000W	13.6Ω	4	130
NE300-4T1600G/1850P-F		9000W	13.6Ω	4	130

* Multi braking resistors parallel connection. E.g. NE300-4T0550G/0750P recommended to select 2 of 6000W, 20Ω resistors parallel connection, compound braking resistor is 12000W, 10Ω.

NE300 braking resistor

Drive model	Braking unit	Braking resistor			Braking torque %
		Braking resistor		Quantity	
NE300-4T1850G/2000P-U	Need external	9000W	13.6Ω	4	130
NE300-4T1850G/2000P-D		9000W	13.6Ω	4	130
NE300-4T1850G/2000P-F		9000W	13.6Ω	4	130
NE300-4T2000G/2200P-U		9000W	13.6Ω	5	130
NE300-4T2000G/2200P-D		9000W	13.6Ω	5	130
NE300-4T2000G/2200P-F		9000W	13.6Ω	5	130
NE300-4T2200G/2500P-U		9000W	13.6Ω	5	130
NE300-4T2200G/2500P-D		9000W	13.6Ω	5	130
NE300-4T2200G/2500P-F		9000W	13.6Ω	5	130
NE300-4T2500G/2800P-U		9000W	13.6Ω	5	130
NE300-4T2500G/2800P-D		9000W	13.6Ω	5	130
NE300-4T2500G/2800P-F		9000W	13.6Ω	5	130
NE300-4T2800G/3150P-F		9000W	13.6Ω	6	130
NE300-4T3150G/3550P-F		9000W	13.6Ω	6	130
NE300-4T3550G/4000P-F		40000W	3Ω	2	130
NE300-4T4000G/4500P-F		40000W	3Ω	2	130
NE300-4T4500G/5000P-F		60000W	2Ω	2	130
NE300-4T5000G/5600P-F		60000W	2Ω	2	130
NE300-4T5600G/6300P-F		60000W	2Ω	2	130
NE300-4T6300G/7100P-F		60000W	2Ω	3	130
NE300-4T7100G/8000P-F		60000W	2Ω	3	130
NE300-4T8000G/9000P-F		80000W	2Ω	3	130
NE300-4T9000G-F		80000W	2Ω	3	130

* Multi braking resistors parallel connection. E.g. NE300-4T0550G/0750P recommended to select 2 of 6000W, 20Ω resistors parallel connection, compound braking resistor is 12000W, 10Ω.

Input/output reactor

DC input reactor parameters

Drive power(KW)	Current(A)	Inductance(mH)	Insulation level
30	65	1.2	F
37	78	1	F
45	95	0.8	F
55	120	0.7	F
75	160	0.5	F
90	180	0.5	F
110	250	0.3	F
132	340	0.3	F

3-phase AC input reactor parameter

Drive power(KW)	Current(A)	Voltage drop (%)	Inductance(mH)	Insulation level
30	80	2	0.17	F
37	90	2	0.16	F
45	120	2	0.12	F
55	150	2	0.095	F
75	200	2	0.07	F
90	240	2	0.06	F
110	250	2	0.06	F
132	290	2	0.05	F
160	330	2	0.042	F
185	390	2	0.039	F
200	490	2	0.028	F
220	490	2	0.028	F
250	530	2	0.026	F
280	600	2	0.023	F
315	660	2	0.022	F
355	800	2	0.018	F
400	1000	2	0.014	F
450	1130	2	0.013	F
500	1250	2	0.012	F

3-phase AC output reactor parameter

Drive power(KW)	Current(A)	Voltage drop (%)	Inductance(mH)	Insulation level
30	80	1	0.35	F
37	90	1	0.32	F
45	120	1	0.24	F
55	150	1	0.19	F
75	200	1	0.14	F
90	240	1	0.12	F
110	250	1	0.12	F
132	290	1	0.1	F
160	330	1	0.087	F
185	390	1	0.075	F
200	490	1	0.058	F
220	490	1	0.058	F
250	530	1	0.054	F
280	600	1	0.048	F
315	660	1	0.044	F
355	800	1	0.036	F
400	1000	1	0.028	F
450	1130	1	0.026	F
500	1250	1	0.024	F

NE300 Options

Optional card	Order code	Terminal	Description	Drive model
I/O extension card	NE30-I/O Lite	X6	Multi-function input 6 (to PLC)	NE300 whole series
		X7	Multi-function input 7 (to PLC)	
		X8	Multi-function input 8 (to PLC)	
		Y2	Multi-function output Y2 (to COM)	
		BRA/BRB/BRC	Relay output 2	
		PLC	PLC common end (to PLC)	
		AO2	Analog output 2 (0 - 10V, 0/4 - 20mA selectable)	
	GND	Analog output common end		
	NE30-I/O Relay	BRA/BRB/BRC	Relay output 2	NE300 whole series
		AO2	Analog output 2 (0 - 10V, 0/4 - 20mA selectable)	
GND		Analog output common		
Injection molding machine extension card	NE30-ZS01	+A1	0-1A current input	NE300-4T0110G/0150PB - NE300-4T9000G-F
		-A1	0-1A current output	
		+A2	0-1A/2A current input	
		-A2	0-1A/2A current output	
		X6	Multi-function input 6 (to COM)	
		COM	Multi-function input common	
+/- 10V extension card	NE30-AN01	485+	485 differential signal positive	NE300 whole series
		485-	485 differential signal negative	
		-10V	Provide -10V to external (to GND)	
		AI3	+/- 10V analog input (to GND)	
		GND	Analog output common	
Speed tracking extension card	NE30-SP01	U	Connect to drive U-phase output	NE300-4T0015G/0022PB - NE300-4T0150G/0185PB
		W	Connect to drive W-phase output	

Connect with us at:



www.controltechniques.com

ASIA PACIFIC

Australia

Email: info.au@mail.nidec.com
T: +612 9 838 7222

India

Email: sales.india@mail.nidec.com
T: +917387007699

Indonesia

Email: info.sg@mail.nidec.com
T: +62 8111 296388

Malaysia

Email: info.sg@mail.nidec.com
T: +6016 2113202

Philippines

Email: info.sg@mail.nidec.com
T: +632 754 7000

Korea

Email: info.kr@mail.nidec.com
T: +82 2 6748 4377
F: +82 2 6748 4394

Singapore

Email: info.sg@mail.nidec.com
T: +65 9617 3556

Bangladesh & Pakistan

Email: sales.india@mail.nidec.com
T: +91 (0) 7358798609

Sri Lanka & Maldives

Email: sales.india@mail.nidec.com
T: +919382321395

Taiwan

Email: info.tw@mail.nidec.com
T: +886 2 2393 1850

Thailand

Email: info.ctt@mail.nidec.com
T: +66 (0)95 463 9000

Vietnam

Email: info.ctt@mail.nidec.com
T: +84 (0)98 390 1050

Cambodia, Laos & Myanmar

Email: info.ctt@mail.nidec.com
T: +66 (0)85 155 1924

Japan

Email: info.japan@mail.nidec.com
T: +81 3 5719 4427

Control Techniques is your global drives specialist.

With operations in over 70 countries, we're open for business wherever you are in the world.

For more information, or to find your local drive centre representatives, visit

www.controltechniques.com



Authorized Distributor
ORIENTAL DM SDN BHD

© 2020 Nidec Control Techniques Limited. The information contained in this brochure is for guidance only and does not form part of any contract. The accuracy cannot be guaranteed as Nidec Control Techniques Ltd have an ongoing process of development and reserve the right to change the specification of their products without notice.

Nidec Control Techniques Limited. Registered Office: The Gro, Newtown, Powys SY16 3BE. Registered in England and Wales. Company Reg. No. 01236886.