

Instruction Manual

AC SERVO MOTOR and SERVO DRIVE
Series Digitax-SF

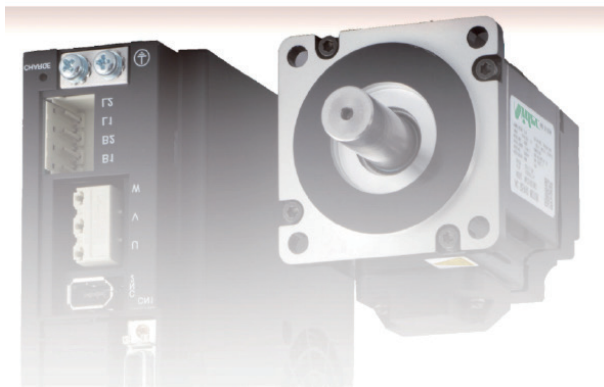

Nidec
All for dreams

Thank you for your purchase of the Digitax SF products. This Instruction Manual includes precautions for the product use.

- Please study this manual first and use the product properly and safely.
- Before using the product, be sure to carefully read the Safety Instructions.
- After reading this manual, please keep it for future reference.
- Product specifications are subject to change without notice in the course of product improvement.

Apr. 2019

Overview of the Digitax SF Instruction Manual

| | |
|---|----------|
| 1. Before Use | 1 |
| Safety Precautions, Safety Standards, Maintenance and Inspection | |
| 2. Specifications | 2 |
| Model Codes, Component Identifications, Specifications, and Dimensions | |
| 3. Preparation | 3 |
| Installation, System Wiring, and Timing Diagrams | |
| 4. Connections | 4 |
| CN1 User I/O Connector Pinout Options and Control Modes | |
| 5. Setting Parameters | 5 |
| Setup Panel and Parameters | |
| 6. Operation | 6 |
| Operation Options for Control Mode, Internal Position Command (Point Table), and Homing | |
| 7. Tuning | 7 |
| Tuning, Control Block Diagrams, Tuning Parameters | |
| 8. Troubleshooting | 8 |
| Warnings, Alarms, and Troubleshooting | |
| 9. Appendices | 9 |
| Absolute System, Emergency Stop, System Block Diagram, and Status Variables | |

Contents

1. Before Use

| | |
|--|----|
| 1. Important Safety Instructions | 2 |
| 2. Overview | 14 |

2. Specifications

| | |
|------------------|----|
| 1. Motor | 2 |
| 2. Encoder | 18 |
| 3. Drive..... | 19 |

3. Preparation

| | |
|--------------------------|----|
| 1. Installation | 2 |
| 2. System Wiring | 7 |
| 3. Timing Diagrams | 24 |

4. Connections

| | |
|--|----|
| 1. Introduction | 2 |
| 2. Position Control Mode | 4 |
| 3. Velocity Control Mode | 18 |
| 4. Torque Control Mode..... | 22 |
| 5. Descriptions of CN1 Connector Signals | 24 |

5. Setting Parameters

| | |
|--|----|
| 1. Overview | 2 |
| 2. Setup Panel | 3 |
| 3. Using the Setup Panel..... | 6 |
| 4. Overview of Digitax SF Connect (Setup Software) | 27 |
| 5. Parameters..... | 28 |

6. Operation

| | |
|------------------------------------|----|
| 1. Configuring Operating Mode..... | 2 |
| 2. Position Control Mode..... | 6 |
| 3. Velocity Control Mode..... | 10 |
| 4. Torque Control Mode..... | 15 |
| 5. Position Control Mode..... | 18 |

7. Tuning

| | |
|---|----|
| 1. Introduction..... | 2 |
| 2. Tuning Procedure..... | 7 |
| 3. Tuning Parameters..... | 26 |
| 4. Using Digitax SF Connect to Measure Vibration Frequency (FFT)..... | 44 |

8. Troubleshooting

| | |
|--------------------------------------|----|
| 1. Checking Warnings and Alarms..... | 2 |
| 2. Warnings and Remedies..... | 5 |
| 3. Alarms and Remedies..... | 8 |
| 4. Troubleshooting..... | 17 |

9. Appendices

| | |
|---|----|
| 1. Absolute System..... | 2 |
| 2. Function..... | 15 |
| 3. Technical Data..... | 16 |
| 4. Status Display..... | 17 |
| 5. How to set Pulse train command: Input filter (33.0)..... | 32 |

1 1

Before Use

| | |
|--|----|
| 1. Important Safety Instructions. | 2 |
| 1. Safety Precautions. | 2 |
| 2. Other Considerations and Precautions. | 10 |
| 3. Safety Standards | 11 |
| 4. Maintenance and Inspection | 13 |
| 2. Overview. | 14 |
| 1. Product Label. | 15 |
| 2. Danger Signs | 16 |

1. Important Safety Instructions

1. Safety Precautions

This manual uses the signs below to indicate serious but avoidable problems caused by misuse of the product. One is for death or serious bodily harm. The other is for bodily injury or product or equipment damage.



Identifies information about imminent hazards that will result in death or serious injury.



Identifies information about hazards that could result in injury or equipment damage.

Throughout this document, the safety precautions that users must follow are marked as follows.

| | |
|--|--|
| | Safety Precaution - Prohibited Action |
| | Safety Precaution - Mandatory Action |

The possible hazardous events are marked as follows.

| | |
|--|--|
| | <p><u>Cautions and Dangers</u></p> <p>Causes unexpected, unstable, or uncontrolled motion. Compromises the performance or reliability of the product. Shortens the service life of the product.</p> |
| | <u>Electric shock hazard</u> |
| | <u>Burn hazard</u> |
| | <u>Fire hazard</u> |
| | <u>Injury hazard</u> |
| | <u>Failure and damage hazard</u> |

Important safety information. Hazards. Competence of designers and installers

This guide applies to products which control electric motors either directly (drives) or indirectly (controllers, option modules and other auxiliary equipment and accessories). In all cases the hazards associated with powerful electrical drives are present, and all safety information relating to drives and associated equipment must be observed.

Specific warnings are given at the relevant places in this guide.

1. Important Safety Instructions

Drives and controllers are intended as components for professional incorporation into complete systems. If installed incorrectly they may present a safety hazard. The drive uses high voltages and currents, carries a high level of stored electrical energy, and is used to control equipment which can cause injury. Close attention is required to the electrical installation and the system design to avoid hazards either in normal operation or in the event of equipment malfunction. System design, installation, commissioning/start-up and maintenance must be carried out by personnel who have the necessary training and competence. They must read this safety information and this guide carefully.

Responsibility

It is the responsibility of the installer to ensure that the equipment is installed correctly with regard to all instructions given in this guide. They must give due consideration to the safety of the complete system, so as to avoid the risk of injury both in normal operation and in the event of a fault or of reasonably foreseeable misuse.

The manufacturer accepts no liability for any consequences resulting from inappropriate, negligent or incorrect installation of the equipment.

Compliance with regulations

The installer is responsible for complying with all relevant regulations, such as national wiring regulations, accident prevention regulations and electromagnetic compatibility (EMC) regulations. Particular attention must be given to the cross-sectional areas of conductors, the selection of fuses or other protection, and protective ground (earth) connections.

This guide contains instructions for achieving compliance with specific EMC standards.

All machinery to be supplied within the European Union in which this product is used must comply with the following directives:

2006/42/EC Safety of machinery.

2014/30/EU: Electromagnetic Compatibility.

Electrical Hazards

The voltages used in the drive can cause severe electrical shock and/or burns, and could be lethal. Extreme care is necessary at all times when working with or adjacent to the drive. Hazardous voltage may be present in any of the following locations:

- AC and DC supply cables and connections
- Output cables and connections
- Many internal parts of the drive, and external option units

Unless otherwise indicated, control terminals are single insulated and must not be touched.

The supply must be disconnected by an approved electrical isolation device before gaining access to the electrical connections.

The control terminal functions of the drive do not isolate dangerous voltages from the output of the drive or from any external option unit.

The drive must be installed in accordance with the instructions given in this guide. Failure to observe the instructions could result in a fire hazard.

1. Important Safety Instructions

Stored Electrical Charge

The drive contains capacitors that remain charged to a potentially lethal voltage after the AC supply has been disconnected. If the drive has been energized, the AC supply must be isolated at least ten minutes before work may continue.

Mechanical Hazards

Careful consideration must be given to the functions of the drive or controller which might result in a hazard, either through their intended behaviour or through incorrect operation due to a fault. In any application where a malfunction of the drive or its control system could lead to or allow damage, loss or injury, a risk analysis must be carried out, and where necessary, further measures taken to reduce the risk – foreexample, an over-speed protection device in case of failure of the speed control, or a fail-safe mechanical brake in case of loss of motor braking.

None of the drive functions must be used to ensure safety of personnel, i.e. they must not be used for safety-related functions. The system designer is responsible for ensuring that the complete system is safe and designed correctly according to the relevant safety standards

Access to equipment

Access must be restricted to authorized personnel only. Safety regulations which apply at the place of use must be complied with.

Environmental limits

Instructions in this guide regarding transport, storage, installation and use of the equipment must be complied with, including the specified environmental limits. This includes temperature, humidity, contamination, shock and vibration. Equipment must not be subjected to excessive physical force.

Hazardous environments

The equipment must not be installed in a hazardous environment (i.e. a potentially explosive environment).

Motor

The safety of the motor under variable speed conditions must be ensured.

To avoid the risk of physical injury, do not exceed the maximum specified speed of the motor.

Mechanical brake control

Any brake control functions are provided to allow well co-ordinated operation of an external brake with the drive. While both hardware and software are designed to high standards of quality and robustness, they are not intended for use as safety functions, i.e. where a fault or failure would result in a risk of injury. In any application where the incorrect operation of the brake release mechanism could result in injury, independent protection devices of proven integrity must also be incorporated.

1. Important Safety Instructions









































Adjusting parameters

Some parameters have a profound effect on the operation of the drive. They must not be altered without careful consideration of the impact on the controlled system. Measures must be taken to prevent unwanted changes due to error or tampering.







Electromagnetic compatibility (EMC)

Installation instructions for a range of EMC environments are provided in an EMC datasheet. If the installation is poorly designed or other equipment does not comply with suitable standards for EMC, the product might cause or suffer from disturbance due to electromagnetic interaction with other equipment. It is the responsibility of the installer to ensure that the equipment or system into which the product is incorporated complies with the relevant EMC legislation in the place of use.

































1. Important Safety Instructions

|  DANGER | | |
|---|---|---|
| Sign | Precautionary Measures | If Not Observed |
| Installation and Wiring | | |
|  | Never connect the motor directly to the AC mains power supply. |   |
| | Do not place any flammable items near the motor or drive. |  |
|  | Protect the drive with a protective enclosure and ensure the clearance between the drive, the enclosure and other devices is as specified in this manual |    |
| | Install the product in a place free from dust, water or oil splash. |    |
| | Mount the motors and drives on metallic or other noncombustible materials. |  |
| | All wiring work must be performed by certified electricians. |  |
| | Ground the FG terminals of motor and drives. |  |
| | Isolate the drive from the power supplies before attempting any wiring. Wiring must be performed correctly |    |
| | Ensure that cable connections are tight. The current-carrying conductors must be insulated. |    |
| Operations | | |
|  | Never touch the inside of the drive. |   |
| | Be careful not to damage the cables. Do not apply excessive force to them or place heavy objects on top of them. Do not let any part of cables become pinched or twisted. |   |
| | Never touch the rotating component of the motor during operation. |  |
| | Do not use the product where it may be subjected to water, corrosive atmosphere, flammable gas, or combustible materials. |  |
| | Do not use the product where excessive vibration or impact load is present. |    |
| | Do not use cables soaked in water or oil. |   |
| | Do not handle wiring nor operate the motor with wet hands. |    |
| | Do not touch the keyway if you are using a motor with a shaft-end keyway. |  |
| | Do not touch the motor or drive heat sink. It becomes very hot. |   |
| | Do not connect the motor directly to the AC mains supply. |  |

















1. Important Safety Instructions

|  DANGER | | |
|---|--|--|
| Sign | Precautionary Measures | If Not Observed |
| Additional Precautions | | |
|  | Install external emergency stop circuitry so that the operation can be stopped and the power supply can be shut down immediately in case of emergency. |  |
| Maintenance and Inspection | | |
|  | Never attempt to disassemble the product. |  |
|  | Hazardous voltages are present in the drive. Before performing any wiring or inspection of the terminal connections, allow more than 5 minutes after the power shuts off for the internal voltage to completely discharge. |  |

1. Important Safety Instructions

|  CAUTION | | |
|--|--|--|
| Sign | Precautionary Measures | If Not Observed |
| Installation and Wiring | | |
|  | Do not directly touch the terminal parts of any connectors |   |
| | Do not block the air vents. Do not allow ingress of any foreign objects to the product. |   |
|  | Keep the motor-drive pairing as specified. |   |
| | Before a test run, confirm that the motor is fixed in place, check the motion while the motor is isolated from the machinery first, then install the motor in the machinery. |  |
| | Observe the mounting method and orientation as specified. |   |
| | Install the product in an appropriate way suitable for its main body mass and the rated output of the product. |   |
| Operations | | |
|  | Do not step on the product or place any heavy object on it. |    |
| | Never make drastic changes during tuning, which if not observed, will result in unstable motion. |  |
| | Do not come close to the machinery right after power restoration following a power outage. The machinery may restart unexpectedly at any moment. Take appropriate measures to ensure safety against an unexpected restart. |  |
| | Do not use the product where it may be exposed to direct sunlight. |  |
| | Do not apply impact load. |  |
| | Never use the AC contactor installed on the main power supply-side to operate or stop the motor. |  |
| | Do not use the built-in brake of the motor for regular braking purposes. It is a holding brake. |   |
| | Do not use faulty, damaged motors or drives |   |
|  | Confirm that the power supplies are within specification. |  |
| | The holding brake is not a stopping device to secure the safety of the machine. The machine requires a separate stopping device to secure safety. |  |
| | Upon occurrence of an alarm, remove the cause and ensure the safe condition of the equipment before resetting the alarm and restarting the machine. |  |
| | Connect the brake control relay and the emergency stop relay in series. |   |

1. Important Safety Instructions

|  CAUTION | | |
|--|---|---|
| Sign | Precautionary Measures | If Not Observed |
| Transportation and Storage | | |
|  | Do not store the product at a location subject to water or moisture, or where toxic gases or liquids are present. |  |
| | Do not hold the cables or motor shafts during transportation. |   |
| | When transporting the drive and motor, do not drop them or let them fall. |   |
|  | When the product has been stored for greater than 1.5 years, contact the supplier. |  |
| | Store the product in suitable storage environment as specified in the instruction manual. |  |
| Additional Precautions | | |
|  | Prior to disposal of the batteries, insulate them with tape or other material. Dispose of them following the local laws and regulations. | |
| | When disposing of the product, treat it as industrial waste. | |
| Maintenance and Inspection | | |
|  | Never attempt to repair the product. In the event of a failure, return the product to the supplier |  |
| | The motor, heat sink of the drive, and braking resistor may become dangerously hot. Do not touch any of them with hands when power is on or for a while after power shutdown. |   |
|  | If the drive or motor fails, shut down both the control power supply and the main circuit power supply. |  |

1. Important Safety Instructions

2. Other Considerations and Precautions

Export of this product or its applications

If the end user or application is involved in military activities or weapons, its export may be subject to **export restrictions**.

Ensure adequate **trade compliance and legal reviews are completed** and follow any required export procedures.

Follow the laws and regulations of the destination country.

Use of the product – suitable applications

This product is designed and manufactured to be used for general industrial products. Medical applications are not allowed.

Applications for special environments or purposes such as nuclear power, aerospace and transportation

Please contact the **supplier** in advance of use if the product is to be used in one of these environments.

Applications that could cause serious accidents or damage due to product failure

Be sure to have safety device or protection device installed before using your equipment.

Applying voltage beyond the rated voltage of the product

Doing so could result in a fire or smoke hazard. Be sure to check and confirm correct **power supply levels** before turning the power on. Be particularly careful in a location such as a clean room.

Operations with the motor shaft not electrically grounded

Depending on the device or installation environment, bearing noise might be increased by galvanic corrosion of the motor bearings. Perform careful check on grounding.

Operations in environment under significant influence of external noise and static electricity

This product has been designed and manufactured to pass extensive noise tests. However, there is a possibility of unexpected behavior depending on user's **environment**. Practice a fail-safe design and take adequate measures to ensure safety within the range of machine motion.

Use of the product in a manner not rated by the manufacturer

Such use shall void the manufacturer's warranty. Do not attempt to do so.

1. Important Safety Instructions

3. Safety Standards



| Rating | | Motor | Drive |
|---|----------------------------|---|---------------------------|
| EU/EC Directives | Low Voltage Directive (*1) | EN60034-1 EN60034-5 | EN61800-5-1 |
| | EMC Directive (*2) | EN61000-6-2 EN55011 Class A, Group1 | |
| | Machinery Directive | (N/A) | (N/A) |
| UL Standards (*1) | | 1004-1 1004-6 (File No.E470950) | 508C (File No.E471456) |
| CSA Standards | | C22.2 No.100 | C22.2 No.14 |
| South Korea Radio Law (KC) | | (N/A) | KN11 KN61000-6-2 |
| China Compulsory Product Certification System (CCC) | | (N/A) | |

*1) Install the product in the environment that meets the following requirements:

- Overvoltage Category II
- Class I
- Pollution Degree 2 (Circuitry)

*2) The test conditions for the machinery and equipment with this product installed may be different from our test conditions. Such machinery or equipment must meet the safety standards for their final configurations.

This declaration is issued under the sole responsibility of the manufacturer

1. Name and address of the manufacturer

Nidec Control Techniques Ltd
The Gro
Newtown
Powys
SY16 3BE
UK

Registered in England and Wales. Company Reg. No. 01236886
Telephone: 00 44 1686 612300
E mail: marketing.controltechniques@mail.nidec.com
Web: www.controltechniques.com

2. Object of the declaration

Digitax SF variable speed AC servo motors and motor drives

| |
|---|
| Servo Motors |
| MY500, MY101, MX201, MZ201, MX401, MZ401, MX751, MZ751, MM102, MH102, MM152, MH152, MM202 |
| Motor Drives |
| DA2YZ23, DA2Z123, DA21223, DA22423, DA23823, DA24A23, DA26B23, DA28C23 |

The model numbers may be followed by other characters that do not affect the ratings.

3. The object of the declaration is in conformity with the relevant European Union harmonisation legislation.

Restriction of Hazardous Substances Directive (2011/65/EU)
Low Voltage Directive (2014/35/EU)
Electromagnetic Compatibility Directive (2014/30/EU).

4. References to the relevant harmonised standards used

The servo motor and drive products listed above have been designed and manufactured in accordance with the following European harmonised standards:

| | |
|----------------------------|---|
| EN 61800-5-1:2007+ A1:2017 | Adjustable speed electrical power drive systems - Part 5-1: Safety requirements - Electrical, thermal and energy |
| EN 60034-1:2010 | Rotating electrical machines - Part 1: Rating and performance |
| EN 60034-5:2001 | Rotating electrical machines - Part 5: Degrees of protection provided by the integral design of rotating electrical machines (IP code) - Classification |
| EN 60034-11:2004 | Rotating electrical machines - Part 11: Thermal protection |
| EN 55011:2009+A1:2010 | Industrial, scientific and medical equipment - Radio-frequency disturbance characteristics - Limits and methods of measurement |
| EN 61000-6-2: 2005 | Electromagnetic compatibility (EMC) - Part 6-2: Generic standards - Immunity for industrial environments |

7. Signed for and on behalf of:





Jon Holman-White
Vice President of Research and Development
Nidec Control Techniques Ltd
Date: 13th June 2019
Newtown, Powys, UK.

These electronic drive products and motors are intended to be used with controllers, electrical protection components and other equipment to form complete end products or systems. Compliance with safety and EMC regulations depends upon installing and configuring the drives and motors correctly, including using the specified input filters. The drives must be installed only by professional installers who are familiar with requirements for safety and EMC. Refer to the Product Documentation. An EMC data sheet is available giving detailed information. The assembler is responsible for ensuring that the product or system complies with all the relevant laws in the country where it is to be used.

1. Important Safety Instructions

4. Maintenance and Inspection

| | |
|---|--|
|  | Never attempt to repair the product. |
|  | For safe use of the product, be sure to perform regular maintenance and inspection of the drive and motor. |
| | Ensure the electrical and mechanical safety before each inspection. |

This product assumes the following operating conditions.

| | |
|---------------------|--|
| Ambient Temperature | Average annual temperature of 30 °C (not exceeding the rated temperature range) |
| Load Factor | 80 % max |
| Operating Hours | 20 hours a day |

Maintenance

For safe use of the product, perform regular inspections.

Check the following before each operation:

- Ambient temperature, humidity and atmosphere
- No foreign objects or dust; especially ensure that nothing is blocking the vent holes
- No excessive bending or damage of the wires
- Power supply voltage is within the specifications
- No foreign objects in moving parts of the device e.g. fan and the range of motion.
- No unusual noise or smell right after the machinery starts.

Check the following at least once a year:

- No loose clamp screw problems in the drive and motor.
- No deformation or discoloration in the drive, motor, cables, and terminal blocks due to overheating.
- No loose wiring fixings or loose terminal block screws.

Misuse or mishandling of the product will not only result in its sub-optimal performance, but also failure or shorter service life.

For safety and proper use of the product, please read the instruction manuals carefully.

About This Product and This Instruction Manual

- Product features and parts are subject to change without prior notice due to potential future product improvement initiatives.
- Please contact us in advance if you are to acquire safety standards certification etc. for equipment with this product installed.
- Include the following precautions in the User Guide of your **Digitax SF** application product:
 - This is a high-voltage product which can be hazardous.
 - Residual voltage exists at the terminals and inside the equipment (even after power shutoff), which is hazardous.
 - The product contains high temperature components.
 - It is prohibited to disassemble the product.
- For optimal service life of the **Digitax SF** product, use of the product under proper conditions is essential. Follow the safety precautions and instructions described in this manual.
- We always strive to include up-to-date information in the instruction manual; therefore, it is subject to change without prior notice.
- For a copy of the latest version of the instruction manual, please contact us.
- Reproducing or copying this document, in whole or in part, without prior approval of **Control Techniques**, is strictly prohibited.

Check Items Upon Unpacking

Please compare the actual items received with your product purchase order.

Inspect all items received for evidence of damage during transit.

Should you have any problems, please contact **the supplier**.

2. Overview

1. Product Label

Motor Label

The product label is separated in two parts which are located shown in this picture.



Label 1

Motor Model

Specifications

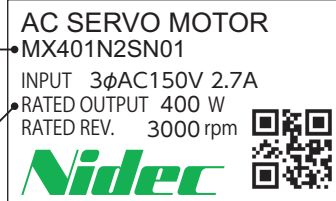

Label 2

Specifications

Product Number

(Produced year and month + Serial No.)

A product number is indicated by 11 digits.

S/N : ** * * * * * * * * * * *
 Year Month^(*) Serial No.

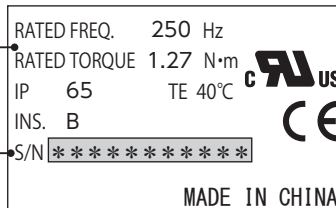

Drive Label

The product label is located on the side cover of the drive.



Drive Model

Product Number

(Produced year and month + Serial No.)

A product number is indicated by 11 digits.

S/N : ** * * * * * * * * * * *
 Year Month^(*) Serial No.

Specifications

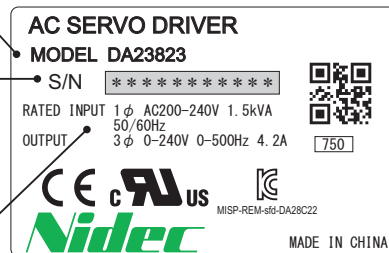

*) About indication of "the month".

"1"=Jan., ... "9"=Sep., "X"=Oct., "Y"=Nov., and "Z" = Dec.

2. Danger Signs

NO IMPACT/NO DISASSEMBLY LABEL



Do not remove the encoder cover. Never attempt to repair or replace the encoder.
Any shock applied to the encoder cover may cause encoder failure.
Do not apply strong impact to the motor or its shaft

HOT SURFACE WARNING



Do not touch the product during operation or for a sufficient period of time afterwards, or you may get burned from the heat.

ELECTRIC SHOCK WARNING



Do not touch the drive during operation and within 5 minutes after the power has been isolated, or you may get injured.

DANGER · CAUTION



Incorrect use of the drive may cause injury or damage. Avoid misuse or improper handling of the drive, or injury may result

FG (PROTECTIVE FRAME GROUND/EARTH) SYMBOL



Be sure to perform grounding with the screw located at this sign.

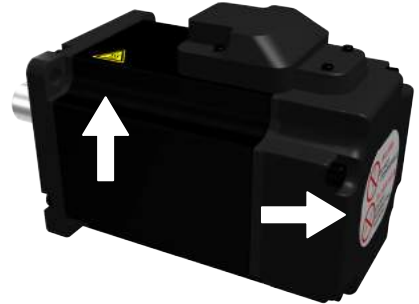

| | |
|-------------------------|----|
| 1. Motor | 2 |
| 1. Models | 2 |
| 2. Names of parts | 3 |
| 3. Specifications | 4 |
| 50 W | 5 |
| 100 W | 7 |
| 200 W | 9 |
| 400 W | 11 |
| 750 W | 13 |
| 1 kW | 15 |
| 1.5 kW | 18 |
| 2 kW | 2 |
| 2. Encoder | 21 |
| 1. Specifications | 21 |
| 3. Drive | 22 |
| 1. Model | 22 |
| 2. Names of parts | 23 |
| 3. Specifications | 25 |
| 4. Dimensions | 31 |

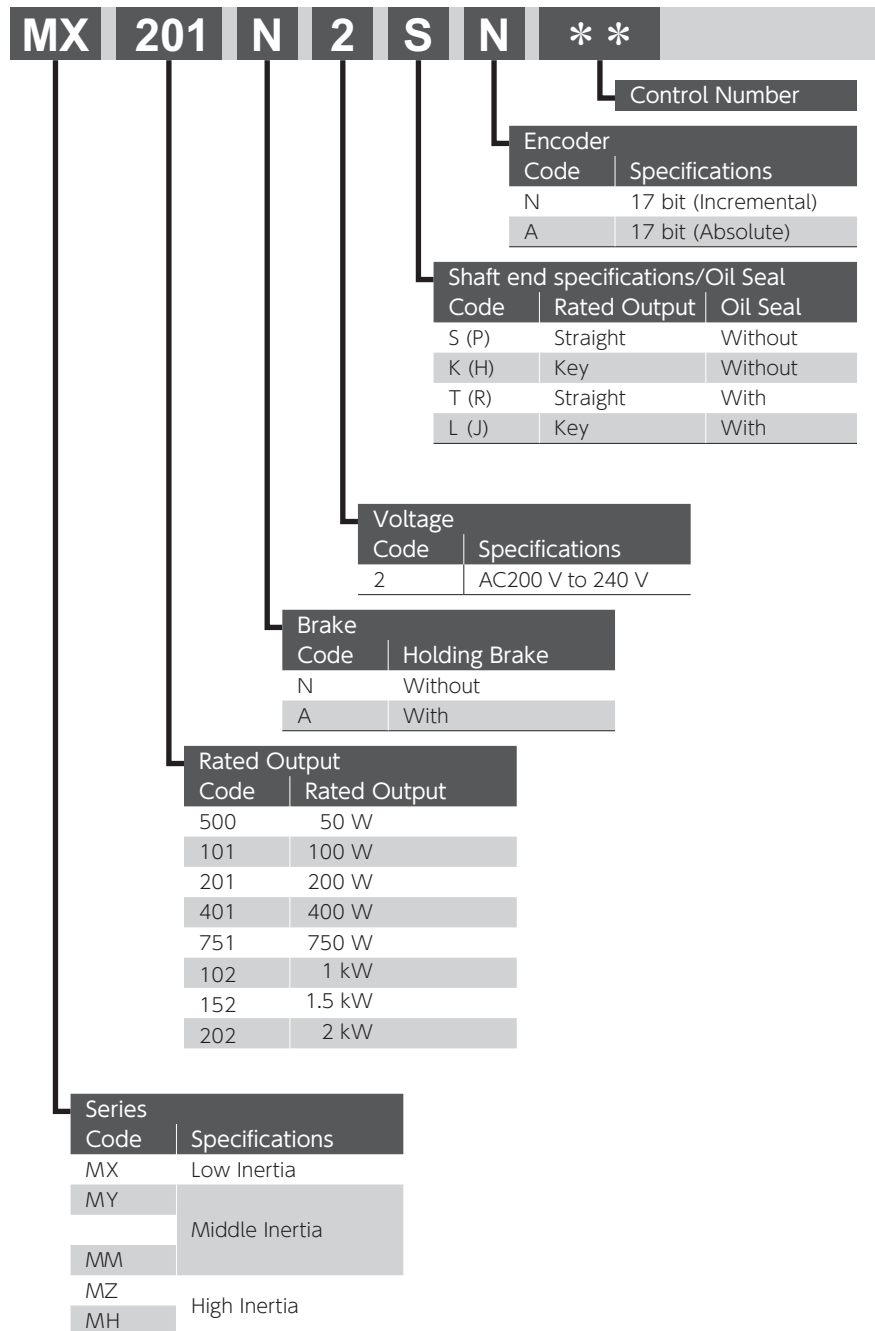

Inertia



Low Inertia



Middle Inertia



High Inertia

Flange Size



40 mm x 40 mm



60 mm x 60 mm



80 mm x 80 mm



130 mm x 130 mm

Rotational Speed



Rated Motor Speed / Max. [rpm]
2,000 / 3,000 [rpm]



3,000 / 6,000 [rpm]

IP Code



IP65



IP67

2. Specifications

1. Motor

2. Names of parts

Motor:

50W

100W

200W

400W

750W

1kW

1.5kW

2kW

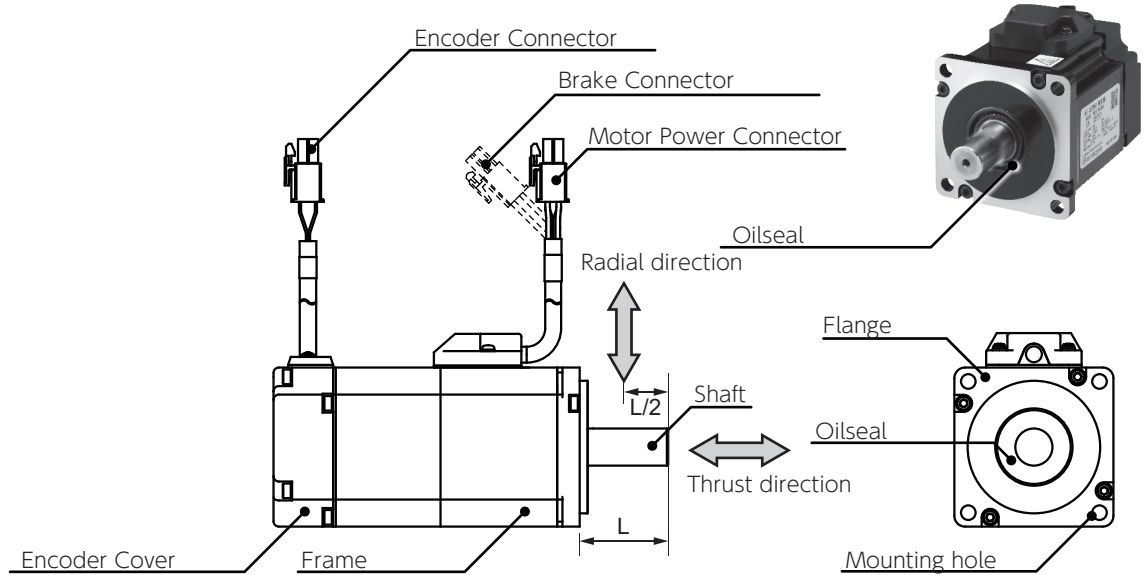

Motor:

50W

100W

200W

400W

750W

1kW

1.5kW

2kW

(MM102 & MH102)

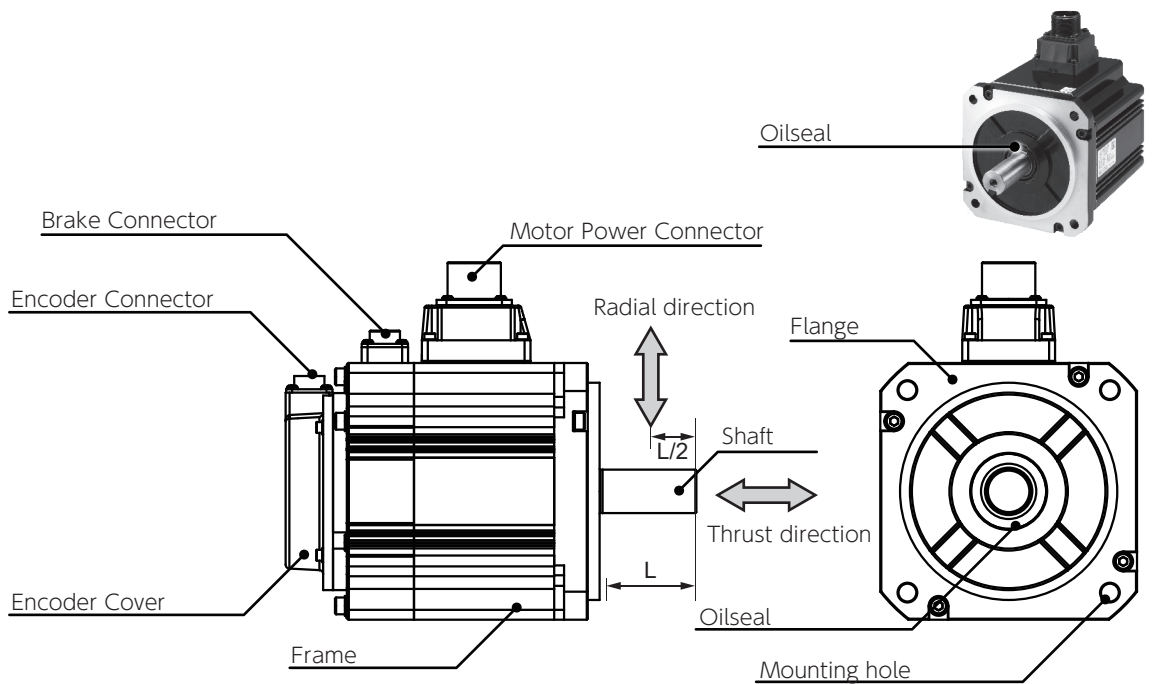

1. Motor

3. Specifications

| Item | Specifications |
|------------------------------------|--|
| Ambient temperature for operation | 0 to 40 °C |
| Ambient humidity for operation | 20 to 85 %RH (no condensation) |
| Ambient temperature for storage | - 20 to 65 °C (no condensation) (not subjected to direct sunlight) 80 °C for 72 hours |
| Ambient humidity for storage | 20 to 85 %RH (no condensation) |
| Atmosphere for operation / storage | Indoors (not subject to direct sunlight) , Free from corrosive gases, flammable gases, oil mist, dust, flammables, grinding fluid |
| Insulation resistance | ≥ 5 MΩ at 1,000 VDC |
| Dielectric strength | AC 1500 V for one minute across the primary and Ground/Earth FG |
| Operating altitude | ≤ 1,000 m |
| Vibration class | V15 (JEC2121) |
| Vibration resistance | 49 m/s ² (5 G) |
| Impact resistance | 98 m/s ² (10 G) |
| Protective structure | IP65 : 50 W to 750 W IP67 : 1 kW to 2 kW |
| Electric shock protection | Class I (Mandatory grounding) |
| Overvoltage category | II |
| Installation environment | Pollution degree 2 |



The brake has polarity.

Lead wire color: Connection
 Yellow (BRK+): +24 V
 Blue (BRK-): GND

Incorrect wiring may result in motor failure or sub-optimal performance of the motor.



2. Specifications

1. Motor

50 W



Motor Model : MY500 □ 2 □ □ * *

| Item | Unit | Specifications | Item | Unit | Specifications | |
|------------------------------------|---------------|---|-----------------|------------------------|----------------|--------|
| Rotor inertia | - | Middle | Usage | - | Holding | |
| Fitting flange size | mm | 40 sq. | Rated voltage | V | DC 24 V ± 10 % | |
| Approximate mass | Without brake | kg | 0.4 | Rated current | A | 0.25 |
| | With brake | kg | 0.6 | Static friction torque | N·m | ≥ 0.16 |
| Compatible drive model | - | DA2YZ _ _ | Engage time | ms | ≤ 35 | |
| Voltage | V | AC200 V to 240 V | Release time | ms | ≤ 20 | |
| Rated output power | W | 50 | Release voltage | V | ≥ DC 1 V | |
| Rated torque | N·m | 0.16 | | | | |
| Instantaneous maximum torque | N·m | 0.56 | | | | |
| Rated current (stall current) | A | 0.68 | | | | |
| Instantaneous maximum current | A | 2.4 | | | | |
| Rated revolving speed | rpm | 3,000 | | | | |
| Maximum revolving speed | rpm | 6,000 | | | | |
| Torque constant | N·m/A | 0.25 | | | | |
| Induced voltage constant per phase | mV/rpm | 8.8 | | | | |
| Rated power rate | Without brake | kW/s | 6.5 | | | |
| | With brake | kW/s | 5.4 | | | |
| Mechanical time constant | Without brake | ms | 1.92 | | | |
| | With brake | ms | 2.31 | | | |
| Electrical time constant | ms | 0.74 | | | | |
| Rotor moment of inertia | Without brake | $\times 10^{-4} \text{kg} \cdot \text{m}^2$ | 0.039 | | | |
| | With brake | $\times 10^{-4} \text{kg} \cdot \text{m}^2$ | 0.047 | | | |

| Item | Unit | Specifications |
|--------|------|----------------|
| Radial | N | 68 |
| Thrust | N | 58 |

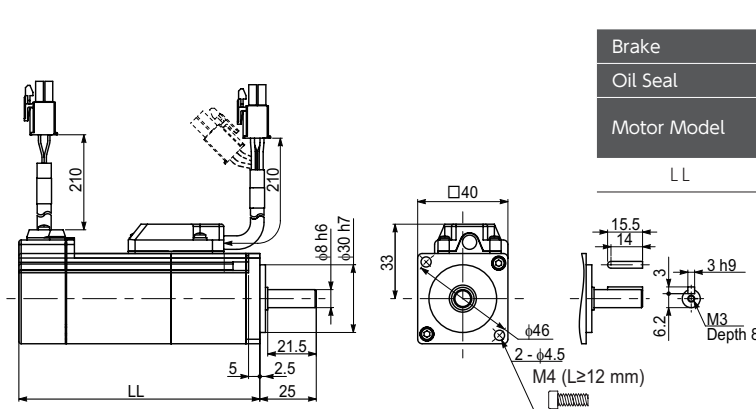
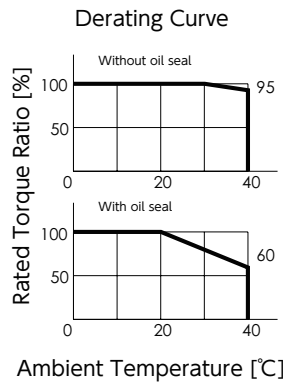
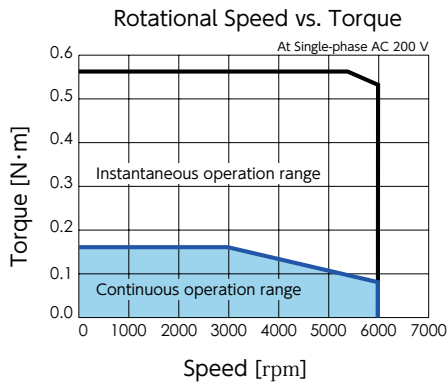

| Brake | Without | | With | |
|-------------|----------|----------|----------|----------|
| | Without | With | Without | With |
| Oil Seal | | | | |
| Motor Model | MY500N2S | MY500N2T | MY500A2S | MY500A2T |
| | MY500N2K | MY500N2L | MY500A2K | MY500A2L |
| LL | 66.4 | 72.0 | 106.8 | 112.4 |

2. Specifications

1. Motor

100 W

100W

40 SQUARE

LM

60-30

IP 65

Motor Model : MY101 □ 2 □ □ * *

| Item | Unit | Specifications | Item | Unit | Specifications | |
|------------------------------------|---------------|---|-----------------|------------------------|----------------|--------|
| Rotor inertia | - | Middle | Usage | - | Holding | |
| Fitting flange size | mm | 40 sq. | Rated voltage | V | DC 24 V ± 10 % | |
| Approximate mass | Without brake | kg | 0.5 | Rated current | A | 0.25 |
| | With brake | kg | 0.8 | Static friction torque | N·m | ≥ 0.32 |
| Compatible drive model | - | DA2Z1 _ _ | Engage time | ms | ≤ 35 | |
| Voltage | V | AC200 V to 240 V | Release time | ms | ≤ 20 | |
| Rated output power | W | 100 | Release voltage | V | ≥ DC 1 V | |
| Rated torque | N·m | 0.32 | | | | |
| Instantaneous maximum torque | N·m | 1.12 | | | | |
| Rated current (stall current) | A | 0.97 | | | | |
| Instantaneous maximum current | A | 3.3 | | | | |
| Rated revolving speed | rpm | 3,000 | | | | |
| Maximum revolving speed | rpm | 6,000 | | | | |
| Torque constant | N·m/A | 0.35 | | | | |
| Induced voltage constant per phase | mV/(rpm) | 12.3 | | | | |
| Rated power rate | Without brake | kW/s | 16.5 | | | |
| | With brake | kW/s | 14.6 | | | |
| Mechanical time constant | Without brake | ms | 1.17 | | | |
| | With brake | ms | 1.32 | | | |
| Electrical time constant | ms | 0.89 | | | | |
| Rotor moment of inertia | Without brake | $\times 10^{-4} \text{kg} \cdot \text{m}^2$ | 0.061 | | | |
| | With brake | $\times 10^{-4} \text{kg} \cdot \text{m}^2$ | 0.069 | | | |

| Item | Unit | Specifications |
|--------|------|----------------|
| Radial | N | 68 |
| Thrust | N | 58 |

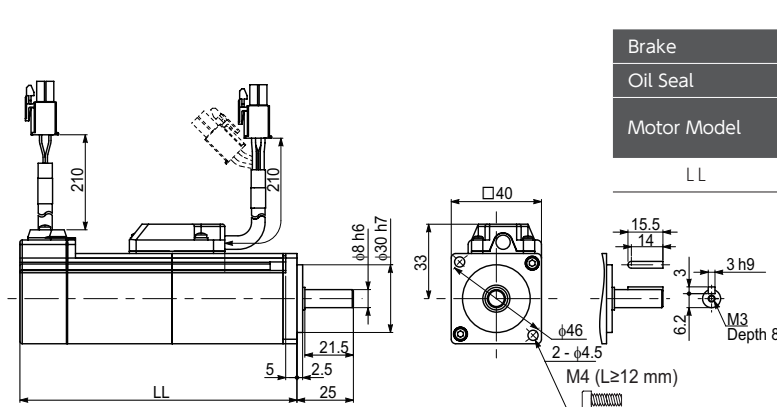
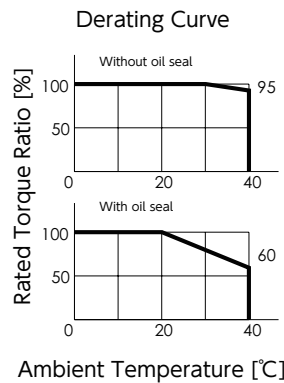
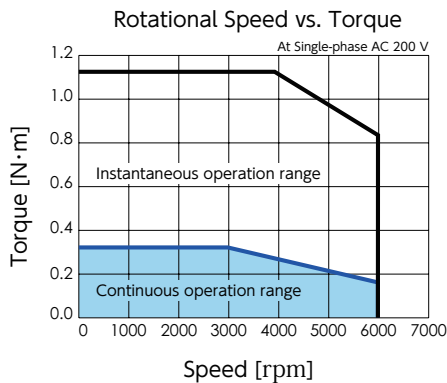

| Brake | Without | | With | |
|-------------|----------|----------|----------|----------|
| | Without | With | Without | With |
| Oil Seal | MY101N2S | MY101N2T | MY101A2S | MY101A2T |
| Motor Model | MY101N2K | MY101N2L | MY101A2K | MY101A2L |
| LL | 82.4 | 88.0 | 122.8 | 128.4 |

2. Specifications

1. Motor

200 W



Motor Model : MX201 □ 2 □ □ * *

| Item | Unit | Specifications | Item | Unit | Specifications | |
|------------------------------------|---------------|---|-----------------|------------------------|----------------|--------|
| Rotor inertia | - | Low | Usage | - | Holding | |
| Fitting flange size | mm | 60 sq. | Rated voltage | V | DC 24V ± 10 % | |
| Approximate mass | Without brake | kg | 0.8 | Rated current | A | 0.3 |
| | With brake | kg | 1.3 | Static friction torque | N·m | ≥ 1.27 |
| Compatible drive model | - | DA212 _ _ | Engage time | ms | ≤ 50 | |
| Voltage | V | AC200 V to 240 V | Release time | ms | ≤ 15 | |
| Rated output power | W | 200 | Release voltage | V | ≥ DC 1 V | |
| Rated torque | N·m | 0.64 | | | | |
| Instantaneous maximum torque | N·m | 1.91 | | | | |
| Rated current (stall current) | A | 1.7 | | | | |
| Instantaneous maximum current | A | 5.2 | | | | |
| Rated revolving speed | rpm | 3,000 | | | | |
| Maximum revolving speed | rpm | 6,000 | | | | |
| Torque constant | N·m/A | 0.41 | | | | |
| Induced voltage constant per phase | mV/(rpm) | 14.3 | | | | |
| Rated power rate | Without brake | kW/s | 28.2 | | | |
| | With brake | kW/s | 23.5 | | | |
| Mechanical time constant | Without brake | ms | 0.72 | | | |
| | With brake | ms | 0.87 | | | |
| Electrical time constant | ms | 2.53 | | | | |
| Rotor moment of inertia | Without brake | $\times 10^{-4} \text{kg} \cdot \text{m}^2$ | 0.14 | | | |
| | With brake | $\times 10^{-4} \text{kg} \cdot \text{m}^2$ | 0.17 | | | |

| Item | Unit | Specifications |
|--------|------|----------------|
| Radial | N | 245 |
| Thrust | N | 98 |

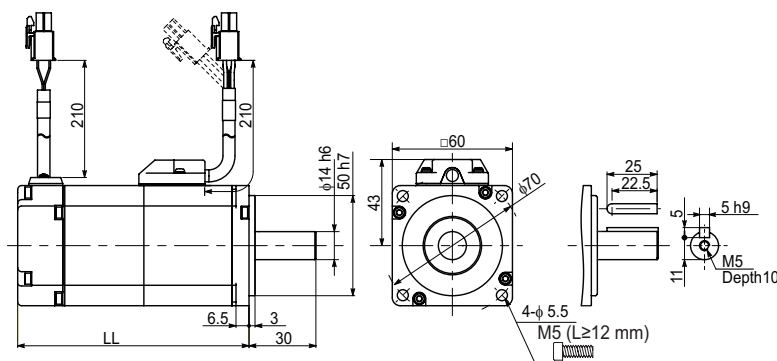
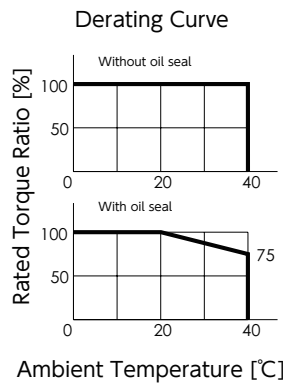
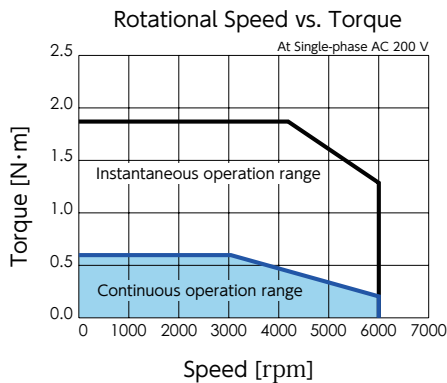

| | (mm) | |
|-------------|---------|--------|
| Brake | Without | With |
| Motor Model | MX201N | MX201A |
| LL | 76.5 | 113.0 |

2. Specifications

1. Motor



Motor Model : MZ201 □ 2 □ □ * *

| Item | Unit | Specifications | Item | Unit | Specifications | |
|------------------------------------|---------------|---|-----------------|------------------------|----------------|--------|
| Rotor inertia | - | High | Usage | - | Holding | |
| Fitting flange size | mm | 60 sq. | Rated voltage | V | DC 24 V ± 10 % | |
| Approximate mass | Without brake | kg | 1.0 | Rated current | A | 0.3 |
| | With brake | kg | 1.5 | Static friction torque | N·m | ≥ 1.27 |
| Compatible drive model | - | DA212 _ _ | Engage time | ms | ≤ 50 | |
| Voltage | V | AC200 V to 240 V | Release time | ms | ≤ 15 | |
| Rated output power | W | 200 | Release voltage | V | ≥ DC 1 V | |
| Rated torque | N·m | 0.64 | | | | |
| Instantaneous maximum torque | N·m | 1.91 | | | | |
| Rated current (stall current) | A | 1.7 | | | | |
| Instantaneous maximum current | A | 5.2 | | | | |
| Rated revolving speed | rpm | 3,000 | | | | |
| Maximum revolving speed | rpm | 6,000 | | | | |
| Torque constant | N·m/A | 0.41 | | | | |
| Induced voltage constant per phase | mV/(rpm) | 14.3 | | | | |
| Rated power rate | Without brake | kW/s | 9.1 | | | |
| | With brake | kW/s | 8.6 | | | |
| Mechanical time constant | Without brake | ms | 2.23 | | | |
| | With brake | ms | 2.38 | | | |
| Electrical time constant | ms | 2.53 | | | | |
| Rotor moment of inertia | Without brake | $\times 10^{-4} \text{kg} \cdot \text{m}^2$ | 0.44 | | | |
| | With brake | $\times 10^{-4} \text{kg} \cdot \text{m}^2$ | 0.47 | | | |

| Item | Unit | Specifications |
|--------|------|----------------|
| Radial | N | 245 |
| Thrust | N | 98 |

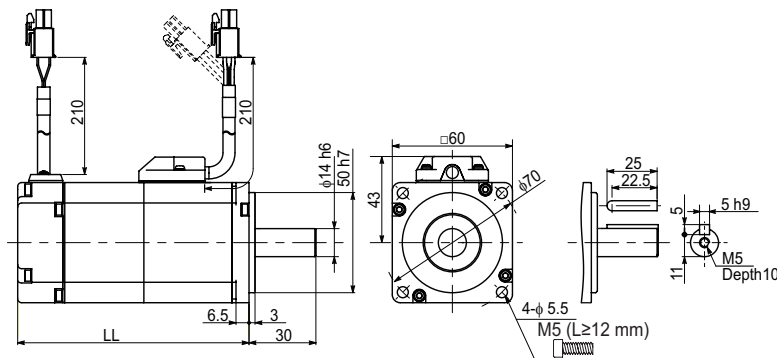
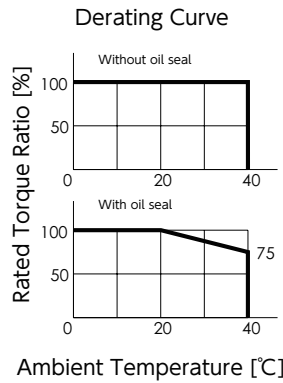
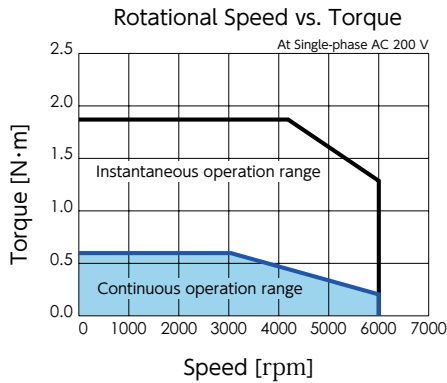

| | (mm) | |
|-------------|---------|--------|
| Brake | Without | With |
| Motor Model | MZ201N | MZ201A |
| LL | 93.5 | 130.0 |

2. Specifications

1. Motor

400 W

400W

60
EAV-DC

LL

60-90

IP
65

Motor Model : MX401 □ 2 □ □ * *

| Item | Unit | Specifications | Item | Unit | Specifications | |
|------------------------------------|---------------|---|-----------------|------------------------|----------------|--------|
| Rotor inertia | - | Low | Usage | - | Holding | |
| Fitting flange size | mm | 60 sq. | Rated voltage | V | DC 24 V ± 10 % | |
| Approximate mass | Without brake | kg | 1.3 | Rated current | A | 0.3 |
| | With brake | kg | 1.8 | Static friction torque | N·m | ≥ 1.27 |
| Compatible drive model | - | DA224 _ _ | Engage time | ms | ≤ 50 | |
| Voltage | V | AC200 V to 240 V | Release time | ms | ≤ 15 | |
| Rated output power | W | 400 | Release voltage | V | ≥ DC 1 V | |
| Rated torque | N·m | 1.27 | | | | |
| Instantaneous maximum torque | N·m | 3.82 | | | | |
| Rated current (stall current) | A | 2.7 | | | | |
| Instantaneous maximum current | A | 8.5 | | | | |
| Rated revolving speed | rpm | 3,000 | | | | |
| Maximum revolving speed | rpm | 6,000 | | | | |
| Torque constant | N·m/A | 0.49 | | | | |
| Induced voltage constant per phase | mV/(rpm) | 17.1 | | | | |
| Rated power rate | Without brake | kW/s | 69.4 | | | |
| | With brake | kW/s | 61.8 | | | |
| Mechanical time constant | Without brake | ms | 0.47 | | | |
| | With brake | ms | 0.53 | | | |
| Electrical time constant | ms | 2.92 | | | | |
| Rotor moment of inertia | Without brake | $\times 10^{-4} \text{kg} \cdot \text{m}^2$ | 0.23 | | | |
| | With brake | $\times 10^{-4} \text{kg} \cdot \text{m}^2$ | 0.26 | | | |

| Item | Unit | Specifications |
|--------|------|----------------|
| Radial | N | 245 |
| Thrust | N | 98 |

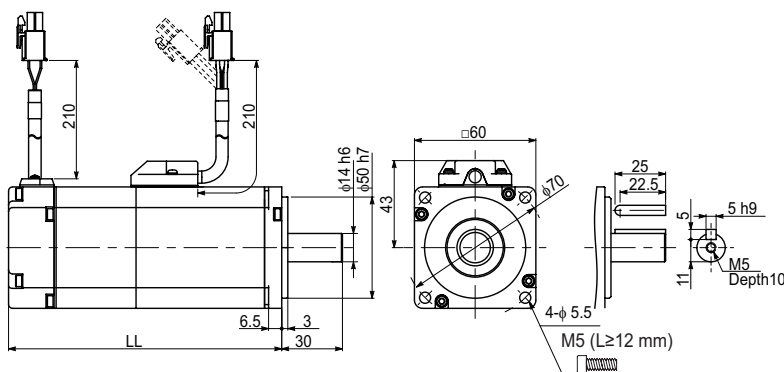
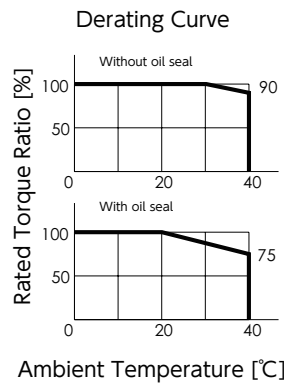
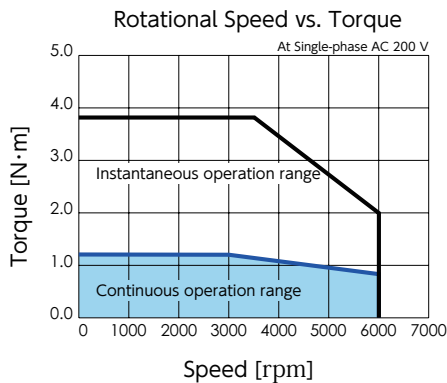

| | (mm) | |
|-------------|---------|--------|
| Brake | Without | With |
| Motor Model | MX401N | MX401A |
| LL | 93.5 | 130.0 |

2. Specifications

1. Motor

400W



Motor Model : MZ401 □ 2 □ □ * *

2 Specifications

1. Motor

| Item | Unit | Specifications | Item | Unit | Specifications | |
|------------------------------------|---------------|---|-----------------|------------------------|----------------|--------|
| Rotor inertia | - | High | Usage | - | Holding | |
| Fitting flange size | mm | 60 sq. | Rated voltage | V | DC 24 V ± 10 % | |
| Approximate mass | Without brake | kg | 1.5 | Rated current | A | 0.3 |
| | With brake | kg | 2.0 | Static friction torque | N·m | ≥ 1.27 |
| Compatible drive model | - | DA224 _ _ | Engage time | ms | ≤ 50 | |
| Voltage | V | AC200 V to 240 V | Release time | ms | ≤ 15 | |
| Rated output Power | W | 400 | Release voltage | V | ≥ DC 1 V | |
| Rated torque | N·m | 1.27 | | | | |
| Instantaneous maximum torque | N·m | 3.82 | | | | |
| Rated current (stall current) | A | 2.7 | | | | |
| Instantaneous maximum current | A | 8.5 | | | | |
| Rated revolving speed | rpm | 3,000 | | | | |
| Maximum revolving speed | rpm | 6,000 | | | | |
| Torque constant | N·m/A | 0.49 | | | | |
| Induced voltage constant per phase | mV/(rpm) | 17.1 | | | | |
| Rated power rate | Without brake | kW/s | 23.0 | | | |
| | With brake | kW/s | 22.1 | | | |
| Mechanical time constant | Without brake | ms | 1.42 | | | |
| | With brake | ms | 1.47 | | | |
| Electrical time constant | ms | 2.92 | | | | |
| Rotor moment of inertia | Without brake | $\times 10^{-4} \text{kg} \cdot \text{m}^2$ | 0.71 | | | |
| | With brake | $\times 10^{-4} \text{kg} \cdot \text{m}^2$ | 0.73 | | | |

| Item | Unit | Specifications |
|--------|------|----------------|
| Radial | N | 245 |
| Thrust | N | 98 |

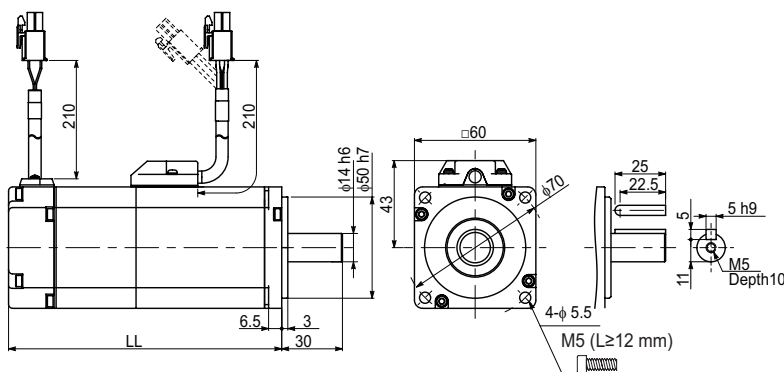
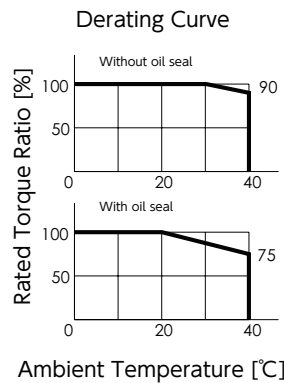
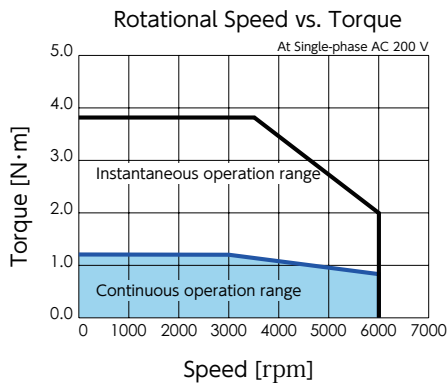

| | (mm) | |
|-------------|---------|--------|
| Brake | Without | With |
| Motor Model | MZ401N | MZ401A |
| LL | 110.5 | 147.0 |

2. Specifications

1. Motor

750 W



Motor Model : MX751 □ 2 □ □ * *

| Item | Unit | Specifications | Item | Unit | Specifications | |
|------------------------------------|---------------|---|-----------------|------------------------|----------------|--------|
| Rotor inertia | - | Low | Usage | - | Holding | |
| Fitting flange size | mm | 80 sq. | Rated voltage | V | DC 24 V ± 10 % | |
| Approximate mass | Without brake | kg | 2.2 | Rated current | A | 0.4 |
| | With brake | kg | 3.0 | Static friction torque | N·m | ≥ 2.39 |
| Compatible drive model | - | DA238 _ _ | Engage time | ms | ≤ 70 | |
| Voltage | V | AC200 V to 240 V | Release time | ms | ≤ 20 | |
| Rated output power | W | 750 | Release voltage | V | ≥ DC 1 V | |
| Rated torque | N·m | 2.39 | | | | |
| Instantaneous maximum torque | N·m | 7.1 | | | | |
| Rated current (stall current) | A | 4.2 | | | | |
| Instantaneous maximum current | A | 12.2 | | | | |
| Rated revolving speed | rpm | 3,000 | | | | |
| Maximum revolving speed | rpm | 6,000 | | | | |
| Torque constant | N·m/A | 0.63 | | | | |
| Induced voltage constant per phase | mV/(rpm) | 21.9 | | | | |
| Rated power rate | Without brake | kW/s | 76.6 | | | |
| | With brake | kW/s | 60.7 | | | |
| Mechanical time constant | Without brake | ms | 0.40 | | | |
| | With brake | ms | 0.50 | | | |
| Electrical time constant | ms | 4.60 | | | | |
| Rotor moment of inertia | Without brake | $\times 10^{-4} \text{kg} \cdot \text{m}^2$ | 0.74 | | | |
| | With brake | $\times 10^{-4} \text{kg} \cdot \text{m}^2$ | 0.94 | | | |

| Item | Unit | Specifications |
|--------|------|----------------|
| Radial | N | 392 |
| Thrust | N | 147 |

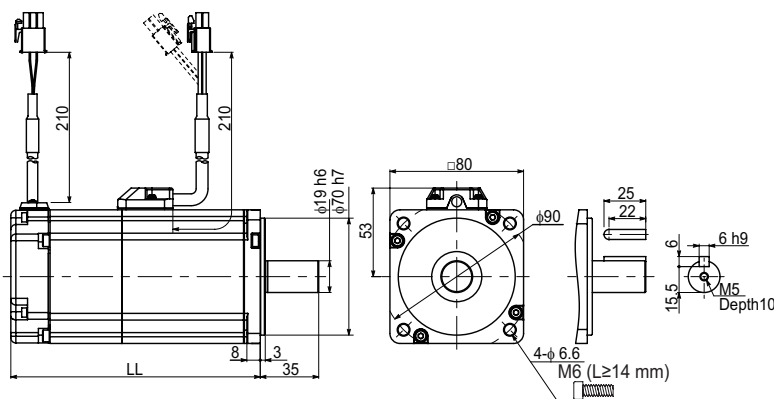
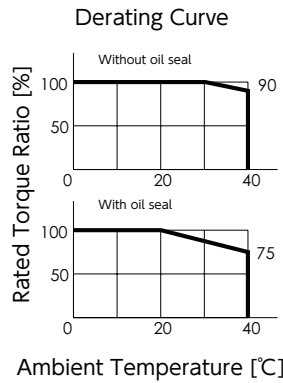
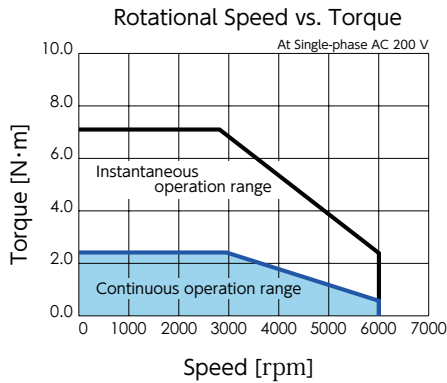

| | (mm) | |
|-------------|---------|--------|
| Brake | Without | With |
| Motor Model | MX751N | MX751A |
| LL | 107.3 | 144.3 |

2. Specifications

1. Motor

750W

30
BLAKE

1.5

60-90

1.5

2 Specifications

1. Motor

Motor Model : MZ751 □ 2 □ □ * *

| Item | Unit | Specifications |
|------------------------------------|---------------|------------------|
| Rotor inertia | - | High |
| Fitting flange size | mm | 80 sq. |
| Approximate mass | Without brake | 2.5 |
| | With brake | 3.3 |
| Compatible drive model | - | DA238 _ _ |
| Voltage | V | AC200 V to 240 V |
| Rated output power | W | 750 |
| Rated torque | N·m | 2.39 |
| Instantaneous maximum torque | N·m | 7.1 |
| Rated current (stall current) | A | 4.2 |
| Instantaneous maximum current | A | 12.2 |
| Rated revolving speed | rpm | 3,000 |
| Maximum revolving speed | rpm | 6,000 |
| Torque constant | N·m/A | 0.63 |
| Induced voltage constant per phase | mV/(rpm) | 21.9 |
| Rated power rate | Without brake | 35.4 |
| | With brake | 31.6 |
| Mechanical time constant | Without brake | 0.86 |
| | With brake | 0.96 |
| Electrical time constant | ms | 4.60 |
| Rotor moment of inertia | Without brake | 1.61 |
| | With brake | 1.81 |

| Item | Unit | Specifications |
|------------------------|------|----------------|
| Usage | - | Holding |
| Rated voltage | V | DC 24 V ± 10 % |
| Rated current | A | 0.4 |
| Static friction torque | N·m | ≥ 2.39 |
| Engage time | ms | ≤ 70 |
| Release time | ms | ≤ 20 |
| Release voltage | V | ≥ DC 1 V |

| Item | Unit | Specifications |
|--------|------|----------------|
| Radial | N | 392 |
| Thrust | N | 147 |

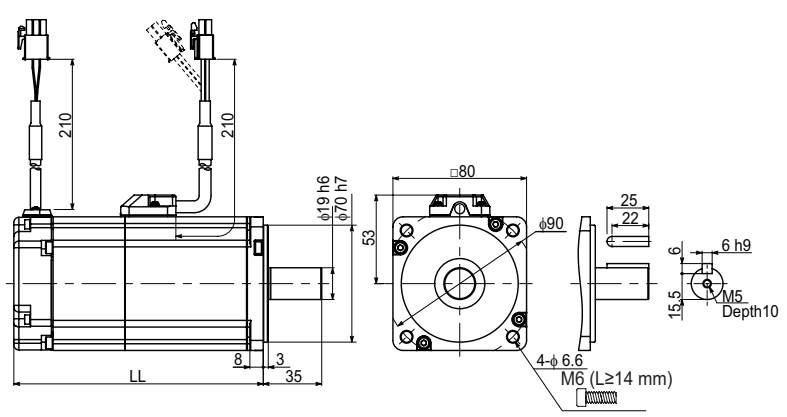
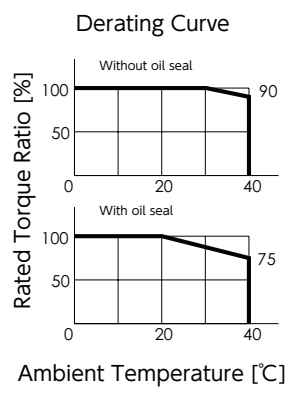
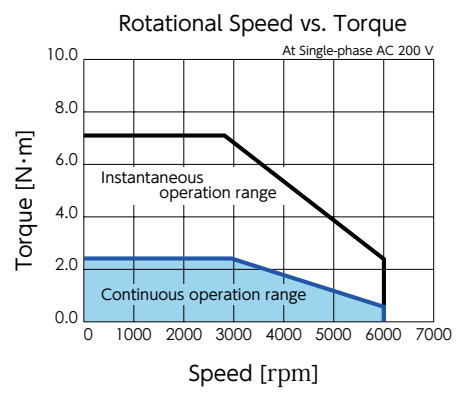

| | (mm) | |
|-------------|---------|--------|
| Brake | Without | With |
| Motor Model | MZ751N | MZ751A |
| LL | 122.3 | 159.3 |

2. Specifications

1. Motor

1kW

180
FLANGE

LM

80-
200

IP
67

2 Specifications

1. Motor

Motor Model : MM102 □ 2 □ □ * *

| Item | Unit | Specifications | Item | Unit | Specifications | |
|------------------------------------|---------------|---|-----------------|------------------------|----------------|--------|
| Rotor inertia | - | Middle | Usage | - | Holding | |
| Fitting flange size | mm | 130 sq. | Rated voltage | V | DC 24 V ± 10 % | |
| Approximate mass | Without brake | kg | 5.6 | Rated current | A | 1.0 |
| | With brake | kg | 7.0 | Static friction torque | N·m | ≥ 9.55 |
| Compatible drive model | - | DA24A _ _ | Engage time | ms | ≤ 120 | |
| Voltage | V | AC200 V to 240 V | Release time | ms | ≤ 30 | |
| Rated output power | W | 1,000 | Release voltage | V | ≥ DC 1 V | |
| Rated torque | N·m | 4.77 | | | | |
| Instantaneous maximum torque | N·m | 14.3 | | | | |
| Rated current (stall current) | A | 5.6 | | | | |
| Instantaneous maximum current | A | 16.8 | | | | |
| Rated revolving speed | rpm | 2,000 | | | | |
| Maximum revolving speed | rpm | 3,000 | | | | |
| Torque constant | N·m/A | 0.88 | | | | |
| Induced voltage constant per phase | mV/(rpm) | 30.9 | | | | |
| Rated power rate | Without brake | kW/s | 50.0 | | | |
| | With brake | kW/s | 36.5 | | | |
| Mechanical time constant | Without brake | ms | 0.76 | | | |
| | With brake | ms | 1.05 | | | |
| Electrical time constant | ms | 10.1 | | | | |
| Rotor moment of inertia | Without brake | $\times 10^{-4} \text{kg} \cdot \text{m}^2$ | 4.56 | | | |
| | With brake | $\times 10^{-4} \text{kg} \cdot \text{m}^2$ | 6.24 | | | |

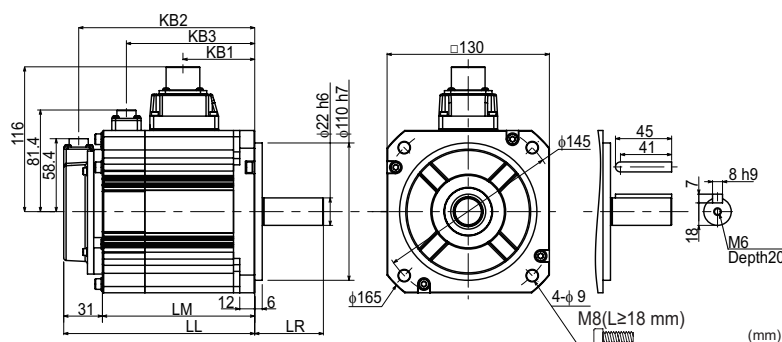
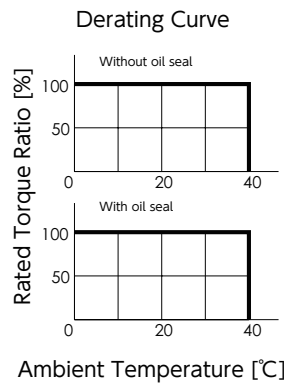
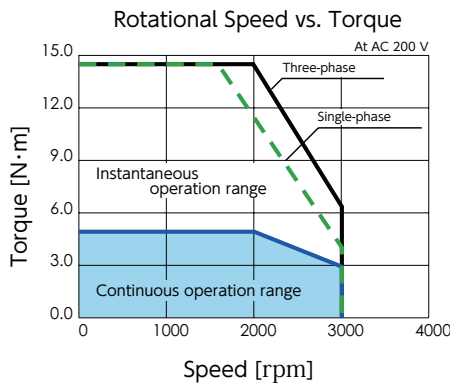

| Brake | Without | With |
|-------------|---------|--------|
| Motor Model | MM102N | MM102A |
| LL | 128.0 | 153.0 |
| LM | 97.0 | 122.0 |
| LR | 55.0 | |
| KB1 | 57.5 | |
| KB2 | 116.0 | 141.0 |
| KB3 | - | 102.8 |

2. Specifications

1. Motor



Motor Model : MH102 □ 2 □ □ * *

| Item | Unit | Specifications | Item | Unit | Specifications | |
|------------------------------------|---------------|---|-----------------|------------------------|----------------|--------|
| Rotor inertia | - | High | Usage | - | Holding | |
| Fitting flange size | mm | 130 sq. | Rated voltage | V | DC 24 V ± 10 % | |
| Approximate mass | Without brake | kg | 7.6 | Rated current | A | 1.0 |
| | With brake | kg | 9.0 | Static friction torque | N·m | ≥ 9.55 |
| Compatible drive model | - | DA24A _ _ | Engage time | ms | ≤ 120 | |
| Voltage | V | AC200 V to 240 V | Release time | ms | ≤ 30 | |
| Rated output power | W | 1,000 | Release voltage | V | ≥ DC 1 V | |
| Rated torque | N·m | 4.77 | | | | |
| Instantaneous maximum torque | N·m | 14.3 | | | | |
| Rated current (stall current) | A | 5.6 | | | | |
| Instantaneous maximum current | A | 16.8 | | | | |
| Rated revolving speed | rpm | 2,000 | | | | |
| Maximum revolving speed | rpm | 3,000 | | | | |
| Torque constant | N·m/A | 0.88 | | | | |
| Induced voltage constant per phase | mV/(rpm) | 30.9 | | | | |
| Rated power rate | Without brake | kW/s | 9.2 | | | |
| | With brake | kW/s | 8.6 | | | |
| Mechanical time constant | Without brake | ms | 4.17 | | | |
| | With brake | ms | 4.43 | | | |
| Electrical time constant | ms | 10.1 | | | | |
| Rotor moment of inertia | Without brake | $\times 10^{-4} \text{kg} \cdot \text{m}^2$ | 24.9 | | | |
| | With brake | $\times 10^{-4} \text{kg} \cdot \text{m}^2$ | 26.4 | | | |

| Item | Unit | Specifications |
|--------|------|----------------|
| Radial | N | 490 |
| Thrust | N | 196 |

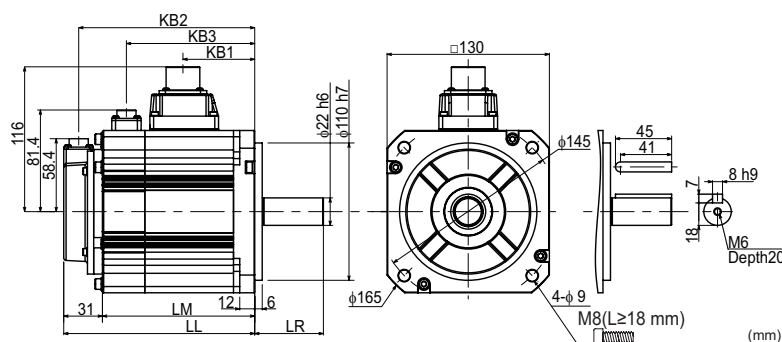
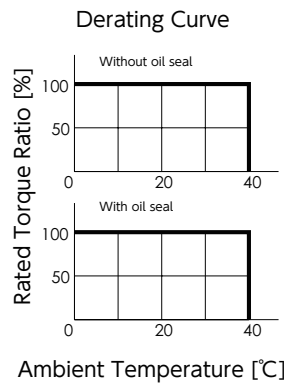
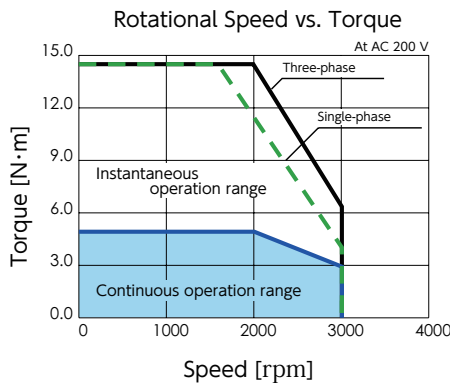

| Brake | Without | With |
|-------------|---------|--------|
| Motor Model | MH102N | MH102A |
| LL | 163.0 | 188.0 |
| LM | 132.0 | 157.0 |
| LR | 70.0 | |
| KB1 | 92.5 | |
| KB2 | 151.0 | 176.0 |
| KB3 | - | 137.8 |

2. Specifications

1. Motor

1.5 kW

1.5kW



Motor Model : MM152 □ 2 □ □ * *

2 Specifications

1. Motor

| Item | Unit | Specifications | |
|------------------------------------|---------------|---|------|
| Rotor inertia | - | Middle | |
| Fitting flange size | mm | 130 sq. | |
| Approximate mass | Without brake | kg | 7.0 |
| | With brake | kg | 8.4 |
| Compatible drive model | - | DA26B _ _ | |
| Voltage | V | AC200 V to 240 V | |
| Rated output power | W | 1,500 | |
| Rated torque | N·m | 7.16 | |
| Instantaneous maximum torque | N·m | 21.5 | |
| Rated current (stall current) | A | 9.0 | |
| Instantaneous maximum current | A | 27 | |
| Rated revolving speed | rpm | 2,000 | |
| Maximum revolving speed | rpm | 3,000 | |
| Torque constant | N·m/A | 0.81 | |
| Induced voltage constant per phase | mV/(rpm) | 28.4 | |
| Rated power rate | Without brake | kW/s | 76.9 |
| | With brake | kW/s | 61.4 |
| Mechanical time constant | Without brake | ms | 0.60 |
| | With brake | ms | 0.75 |
| Electrical time constant | ms | 12.2 | |
| Rotor moment of inertia | Without brake | $\times 10^{-4} \text{kg} \cdot \text{m}^2$ | 6.67 |
| | With brake | $\times 10^{-4} \text{kg} \cdot \text{m}^2$ | 8.35 |

| Item | Unit | Specifications |
|------------------------|------|-------------------------------|
| Usage | - | Holding |
| Rated voltage | V | DC 24 V \pm 10 % |
| Rated current | A | 1.0 |
| Static friction torque | N·m | ≥ 9.55 |
| Engage time | ms | ≤ 120 |
| Release time | ms | ≤ 30 |
| Release voltage | V | $\geq \text{DC } 1 \text{ V}$ |

| Item | Unit | Specifications |
|--------|------|----------------|
| Radial | N | 490 |
| Thrust | N | 196 |

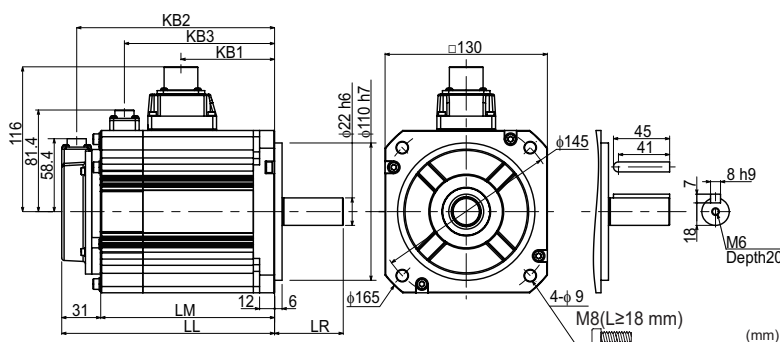
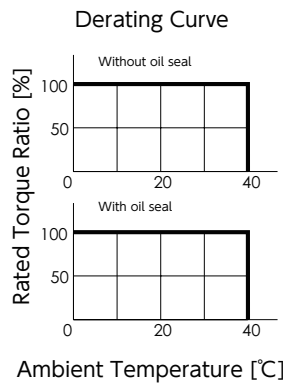
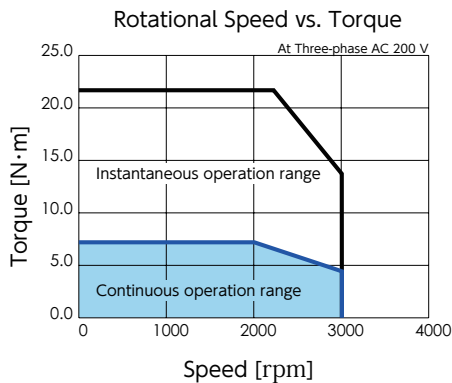

| Brake | (mm) | |
|-------------|---------|--------|
| | Without | With |
| Motor Model | MM152N | MM152A |
| LL | 145.5 | 170.5 |
| LM | 114.5 | 139.5 |
| LR | 55.0 | |
| KB1 | 75.0 | |
| KB2 | 133.5 | 158.5 |
| KB3 | - | 120.3 |

2. Specifications

1. Motor

1.5kW



Motor Model : MH152 □ 2 □ □ * *

| Item | Unit | Specifications | Item | Unit | Specifications | |
|------------------------------------|---------------|---|-----------------|------------------------|----------------|--------|
| Rotor inertia | - | High | Usage | - | Holding | |
| Fitting flange size | mm | 130 sq. | Rated voltage | V | DC 24 V ± 10 % | |
| Approximate mass | Without brake | kg | 9.0 | Rated current | A | 1.0 |
| | With brake | kg | 10.4 | Static friction torque | N·m | ≥ 9.55 |
| Compatible drive model | - | DA26B _ _ | Engage time | ms | ≤ 120 | |
| Voltage | V | AC200 V to 240 V | Release time | ms | ≤ 30 | |
| Rated output power | W | 1,500 | Release voltage | V | ≥ DC 1 V | |
| Rated torque | N·m | 7.16 | | | | |
| Instantaneous maximum torque | N·m | 21.5 | | | | |
| Rated current (stall current) | A | 9.0 | | | | |
| Instantaneous maximum current | A | 27 | | | | |
| Rated revolving speed | rpm | 2,000 | | | | |
| Maximum revolving speed | rpm | 3,000 | | | | |
| Torque constant | N·m/A | 0.81 | | | | |
| Induced voltage constant per phase | mV/(rpm) | 28.4 | | | | |
| Rated power rate | Without brake | kW/s | 13.8 | | | |
| | With brake | kW/s | 13.3 | | | |
| Mechanical time constant | Without brake | ms | 3.32 | | | |
| | With brake | ms | 3.46 | | | |
| Electrical time constant | ms | 12.2 | | | | |
| Rotor moment of inertia | Without brake | $\times 10^{-4} \text{kg} \cdot \text{m}^2$ | 37.12 | | | |
| | With brake | $\times 10^{-4} \text{kg} \cdot \text{m}^2$ | 38.65 | | | |

| Item | Unit | Specifications |
|--------|------|----------------|
| Radial | N | 490 |
| Thrust | N | 196 |

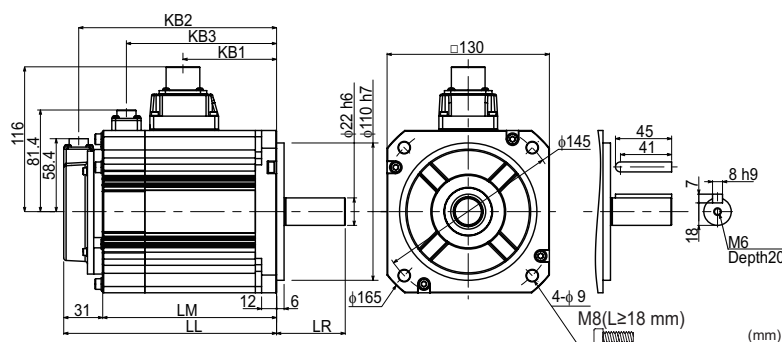
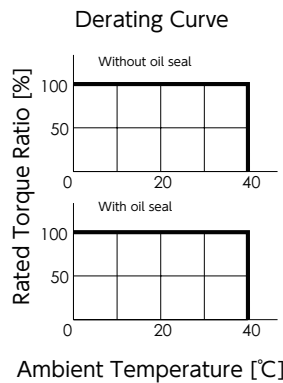
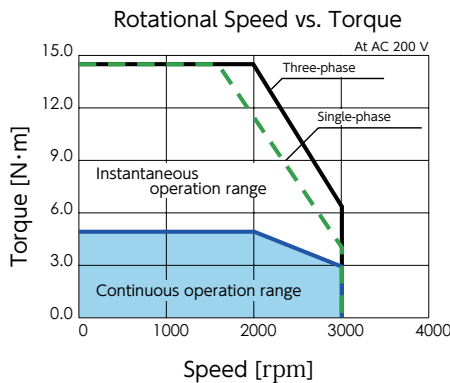

| Brake | Without | With |
|-------------|---------|--------|
| Motor Model | MH152N | MH152A |
| LL | 180.5 | 205.5 |
| LM | 149.5 | 174.5 |
| LR | 70.0 | |
| KB1 | 110.0 | |
| KB2 | 168.5 | 19.35 |
| KB3 | - | 155.3 |

2. Specifications

1. Motor

2 kW



Motor Model : MM202 □ 2 □ □ * *

2 Specifications

1. Motor

| Item | Unit | Specifications | |
|------------------------------------|---------------|---|-------|
| Rotor inertia | - | Middle | |
| Fitting flange size | mm | 130 sq. | |
| Approximate mass | Without brake | kg | 8.4 |
| | With brake | kg | 9.8 |
| Compatible drive model | - | DA28C _ _ | |
| Voltage | V | AC200 V to 240 V | |
| Rated output power | W | 2,000 | |
| Rated torque | N·m | 9.55 | |
| Instantaneous maximum torque | N·m | 28.6 | |
| Rated current (stall current) | A | 11.9 | |
| Instantaneous maximum current | A | 35.7 | |
| Rated revolving speed | rpm | 2,000 | |
| Maximum revolving speed | rpm | 3,000 | |
| Torque constant | N·m/A | 0.85 | |
| Induced voltage constant per phase | mV/(rpm) | 29.6 | |
| Rated power rate | Without brake | kW/s | 104.9 |
| | With brake | kW/s | 87.9 |
| Mechanical time constant | Without brake | ms | 0.58 |
| | With brake | ms | 0.69 |
| Electrical time constant | ms | 12.2 | |
| Rotor moment of inertia | Without brake | $\times 10^{-4} \text{kg} \cdot \text{m}^2$ | 8.70 |
| | With brake | $\times 10^{-4} \text{kg} \cdot \text{m}^2$ | 10.38 |

| Item | Unit | Specifications |
|------------------------|------|--------------------|
| Usage | - | Holding |
| Rated voltage | V | DC 24 V \pm 10 % |
| Rated current | A | 1.0 |
| Static friction torque | N·m | \geq 9.55 |
| Engage time | ms | \leq 120 |
| Release time | ms | \leq 30 |
| Release voltage | V | \geq DC 1 V |

| Item | Unit | Specifications |
|--------|------|----------------|
| Radial | N | 490 |
| Thrust | N | 196 |

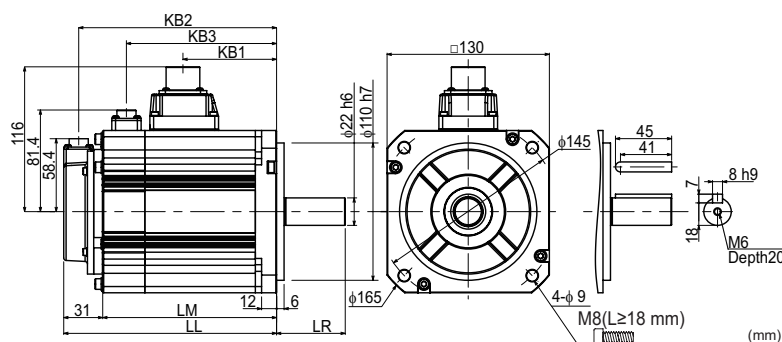
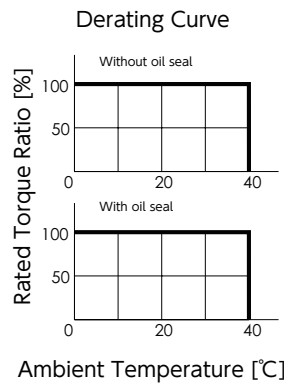
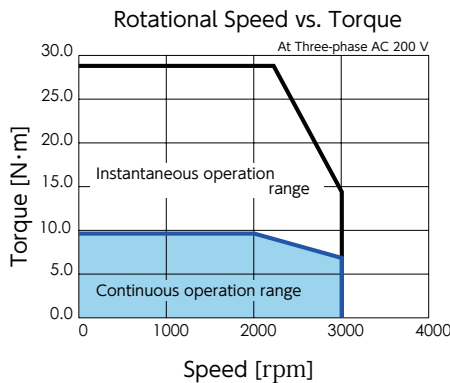

| | (mm) | |
|-------------|---------|--------|
| Brake | Without | With |
| Motor Model | MM202N | MM202A |
| LL | 163.0 | 188.0 |
| LM | 132.0 | 157.0 |
| LR | 55.0 | |
| KB1 | 92.5 | |
| KB2 | 151.0 | 176.0 |
| KB3 | - | 137.8 |

2. Specifications

2. Encoder

1. Specifications

| Item | Specifications | | | |
|-----------------------------|-------------------------------------|---|---|----------------------------|
| Motor model | M□□□□□2□N** | M□□□□□2□A** | | |
| Resolution | Incremental 17 bit | Absolute 17 bit | | |
| Environmental requirements | Ambient operating temperature | 0 to 85 °C | | |
| | External disturbance magnetic field | ±2 mT (20 G) or below | | |
| Electrical specifications | Power supply | Voltage | DC 4.5 to 5.5 V (Power supply ripple ≤ 5 %) | |
| | | Current consumption | 160 mA typ. (Not including inrush current) | |
| | External battery | Voltage | - | DC 2.4 to 4.2V |
| | | Current consumption | - | 10 μA typ. ^{(*)1} |
| | Multi-turn count | - | 65,536 counts | |
| | Maximum revolving speed | 6,000 rpm | | |
| | Count-up direction | CCW ^{(*)2} | | |
| Input/output type | Differential | | | |
| Communication specification | Transmission method | Half-duplex asynchronous serial communication | | |
| | Communication speed | 2.5 Mbps | | |

- *1) Measurement conditions
room temperature, the motor not in motion, battery voltage of 3.6 V.
- *2) CCW when viewed from the load side shaft end.

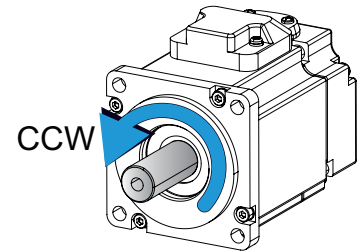

Precautions

Using the motor with rotations of 180 degrees or less will reduce the encoder's rotational accuracy.
 For a motor equipped with a brake, follow the brake voltage and polarity specifications.
 If the brake voltage is less than 12 V or the polarity is reversed, the encoder's rotational accuracy will be reduced due to changes in the magnetic field around the encoder.

1. Model

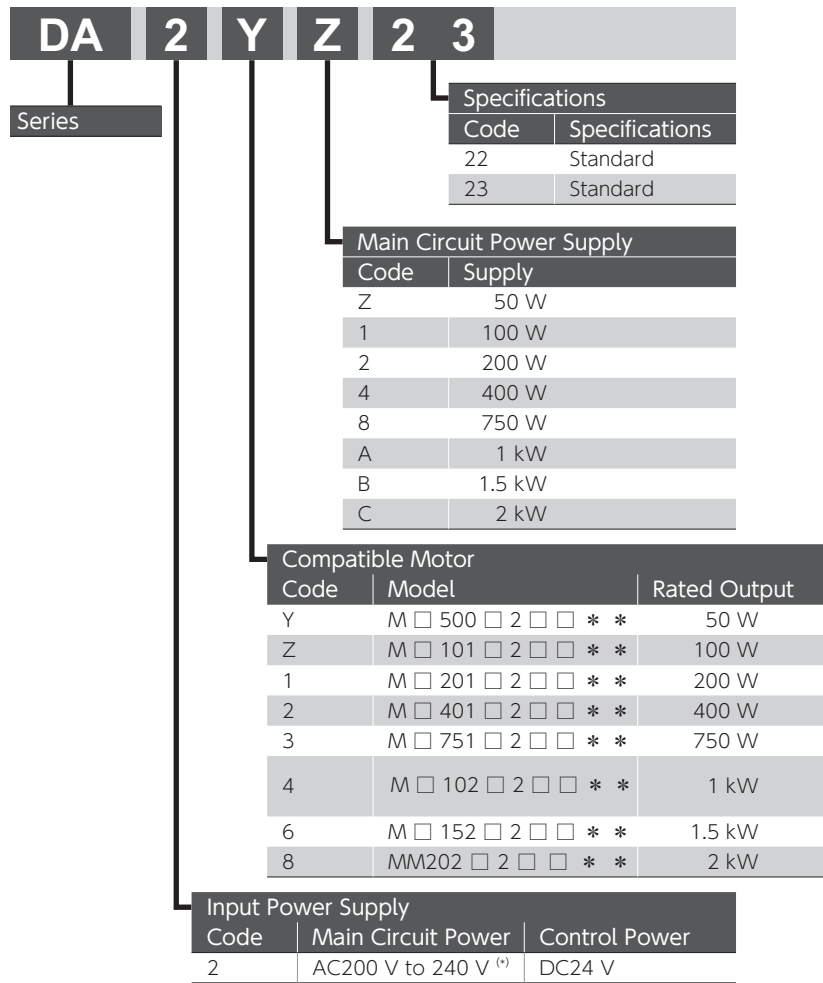

(*) Single- or Three-phase option depends on compatible motor.
 50 W to 750 W : Single-phase
 1 kW : Single-phase / Three-phase
 1.5 kW, 2 kW : Three-phase

Drive / Motor Combinations

| Drive | Motor | Motor Rated Output Power |
|---------|--|--------------------------|
| DA2YZ23 | MY500 □ 2 □ □ * * | 50 W |
| DA2Z123 | MY101 □ 2 □ □ * * | 100 W |
| DA21223 | MX201 □ 2 □ □ * *, MZ201 □ 2 □ □ * * | 200 W |
| DA22423 | MX401 □ 2 □ □ * *, MZ401 □ 2 □ □ * * | 400 W |
| DA23823 | MX751 □ 2 □ □ * *, MZ751 □ 2 □ □ * * | 750 W |
| DA24A23 | MM102 □ 2 □ □ * * MH102 □ 2 □ □ * * | 1 kW |
| DA26B23 | MM152 □ 2 □ □ * *, MH152 □ 2 □ □ * * | 1.5 kW |
| DA28C23 | MM202 □ 2 □ □ * * | 2 kW |



Use a motor and the drive in a correct combination.



3. Drive

2. Names of parts

Drive:



Mounting holes

∅ 5.5 (one location)
The recommended screw: M5x12 mm, with spring washer

Setting panel

Used for parameter setting, tuning, and status display

Motor power connector

UVW: Motor power output
B1 B2: Braking resistor connection

Main power connection

L1 L2: Single-phase AC200 V input

Ground/Earth FG(Protective earth) terminal

Two terminals:
M4x8 mm screw with spring washer

CN3 PC communication connector

Used for parameter settings, tuning, and status display in the dedicated software "Digitax SF Connect"

CN1 User I/O connector

Control power input, Command input, Parallel I/O, and ABZ output

CN2 Encoder connector

Encoder connection

Mounting notch

∅ 5.5 (one location)
The recommended screw:
M5x12 mm with spring washer

Hazardous voltage display LED

This will be lit while there is residual hazardous voltage inside the drive.

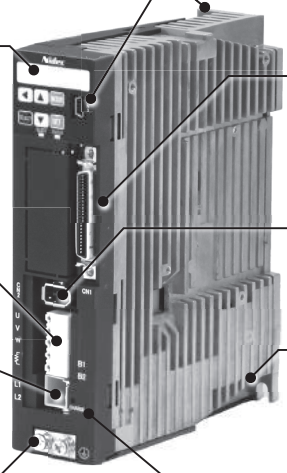

Drive:



Mounting holes

∅ 5.5 (one location)
The recommended screw: M5 × 12 mm, with spring washer

Setting panel

Used for parameter setting, tuning, and status display

Motor power connector

UVW: Motor power output

Main power connection

B1 B2: Braking resistor connection

L1 L2: Single-phase AC200 V input

Hazardous voltage display LED

This will be lit while there is residual hazardous voltage inside the drive.

Ground/Earth FG(Protective earth) terminal

Two terminals:
M4x8 mm screw with spring washer

CN3 PC communication connector

Used for parameter settings, tuning, and status display in the dedicated software "Digitax SF Connect"

CN1 User I/O connector

Control power input, Command input, Parallel I/O, and ABZ output

CN2 Encoder connector

Encoder connection

Mounting notch

∅ 5.5 (one location)
The recommended screw:
M5x12 mm with spring washer

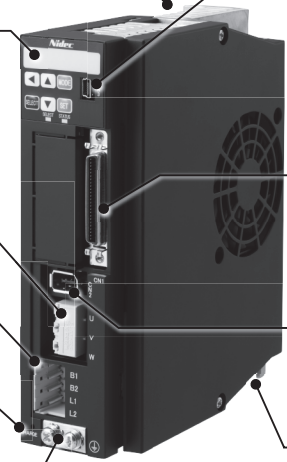

Drive:

50W

100W

200W

400W

750W

1kW

1.5kW

2kW

Mounting holes

∅ 5.5 (two locations)
The recommended screw: M5x12 mm and 8 mm, with spring washer

Setting panel

Used for parameter setting, tuning, and status display

Motor power connector

UVW: Motor power output

Main power connection

B1 B2: Braking resistor connection
L1 L2 L3: Single-phase AC200 V input

Hazardous voltage display LED

This will be lit while there is residual hazardous voltage inside the drive.

Ground/Earth FG(Protective earth) terminal

Two terminals:
M4x8 mm screw with spring washer

CN3 PC communication connector

Used for parameter settings, tuning, and status display in the dedicated software "Digitax SF Connect"

CN1 User I/O connector

Control power input, Command input, Parallel I/O, and ABZ output

CN2 Encoder connector

Encoder connection

Mounting notch

∅ 5.5 (one location)
The recommended screw: M5x12 mm with spring washer



3. Drive

3. Specifications

Basic Specifications

| Item | Specifications | | | | | | | | | | |
|-------------------------------|---|--|-----------|-----------|-----------|-----------|--|-----------|-------------------------------|------|--|
| Model | DA2YZ _ _ | DA2Z1 _ _ | DA212 _ _ | DA224 _ _ | DA238 _ _ | DA24A _ _ | DA26B _ _ | DA28C _ _ | | | |
| Compatible Motor | M□500 | M□101 | M□201 | M□401 | M□751 | M□102 | M□152 | MM202 | | | |
| External dimensions | (See "Dimensions" beginning on page 31.) | | | | | | | | | | |
| Weight (kg) | 0.7 | | | | 0.8 | | 1.0 | | 1.6 | | |
| Input power | Main circuit power | Single-phase AC200 V to 240 V ± 10 % 50 / 60 Hz | | | | | Three-phase AC200 V to 240 V ^(*) ± 10 % 50 / 60 Hz | | | | |
| | Control power ^{(*)2} | DC24V ± 10 % | | | | | | | | | |
| | Input current (Arms typ) | 0.8 | 1.3 | 2.4 | 3.6 | 7.2 | Single-phase : 9.7 Three-phase : 5.1 | | 6.1 | 9.0 | |
| | Control power Current Consumption (mA Typ.) | 170 | | | 210 | 260 | 350 | | (Inrush current approx.1.4 A) | | |
| Control type | Three-phase PWM inverter sine-wave driven | | | | | | | | | | |
| Output Rating | Rated current (A) | 0.7 | 1.0 | 1.7 | 2.7 | 4.3 | 5.6 | | 9.9 | 12.2 | |
| | Output frequencies (Hz) | 0 to 500 | | | | | 0 to 250 | | | | |
| Encoder feedback | 17 bit single-turn absolute (The product can function as a multi-turn absolute type when batteries are added.) | | | | | | | | | | |
| Control signal | Input | 8-point (24 VDC system, opto-coupler input insulation) inputs whose functions are switched by the control mode | | | | | | | | | |
| | Output | 8-point (24 VDC system, open-collector output insulation) outputs whose functions are switched by the control mode | | | | | | | | | |
| Analog signal | Input | Single ended (± 10 V) input whose functions can be switched by the control mode | | | | | | | | | |
| Pulse signal | Input | RS-422 differential Open-collector | | | | | | | | | |
| | Output | Encoder feedback pulse (A-/B-/Z-phase), RS-422 differential output Z-phase pulse through open-collector as well | | | | | | | | | |
| Communication function | USB : connection to PC with "Digitax SF Connect" installed RS-485 : host remote control communication (multi-drop compatible) | | | | | | | | | | |
| Drive status display function | Drive status display function 6 digits of seven-segment display on Setup Panel Normal/Error display on STATUS LED Green light when Power ON Normal, Red light when Power ON Error, Dim when Power OFF | | | | | | | | | | |
| Regeneration function | A braking resistor may be installed externally ^{(*)3} | | | | | | | | | | |
| Control mode | Position Control, Velocity Control, Torque Control | | | | | | | | | | |

Environmental Specification

| Item | | Specifications |
|--------------------------------------|---------------|--|
| Ambient temperature | For operation | 0 to 50 °C (+5) |
| | For storage | -20 to 65 °C |
| Ambient humidity | For operation | 20 to 85 % RH (no condensation) |
| | For storage | |
| Atmosphere for operation and storage | | Indoors (not subject to direct sunlight) , Free from corrosive gases, flammable gases, oil mist, dust, flammables, grinding fluid |
| Altitude | | ≤ 1,000 m |
| Vibration | | ≤ 5.8 m/s ² (0.6 G) 10 to 60 Hz (no continuous operation allowed at resonant frequency) |
| Dielectric strength | | AC 1,500 V for one minute across the primary and Ground/Earth FG |
| Electric shock protection | | Class I (mandatory grounding) |
| Overvoltage category | | II |
| Installation environment | | Pollution degree 2 |

Functions Specifications

Position Control Mode

| Item | Specifications | |
|----------------------------|--|--|
| Pulse Input | Control input | Servo ON, alarm reset, command input inhibit, emergency stop, position error counter clear, 2-stage torque limit, CCW/CW run inhibit (limit switch input), ABS data demand, homing start |
| | Control output | Alarm status, servo status, servo ready, under torque limit, brake release, positioning complete, motion complete, alarm, emergency stop brake release, ABS data transmitting, homing complete |
| | Maximum command pulse frequency | RS-422 differential : 4 Mpps Open-collector : 200 kpps |
| | Input pulse signal form ⁽⁺⁶⁾ | Pulse + Direction, A-/B-phase quadrature encoder pulse, CW + CCW pulse |
| Command pulse-paired ratio | ratio A/B $1/1,000 < A/B < 1,000$ Setting range A : 1 to 65,535 B : 1 to 65,535 | |
| Internal Position | Control input | Servo ON, alarm reset, position error counter clear, motion start point selection 16, home position sensor input, homing start |
| | Control output | Alarm status, servo status, servo ready, under torque limit, brake release, homing complete, motion complete |
| | Operation mode | Point table, communication operation |
| Smoothing filter | FIR Filter | |
| Damping control | Enabled | |

Velocity Control Mode

| Item | Specifications | |
|-------------------|------------------------|---|
| Analog Velocity | Control input | Servo ON, alarm reset, command input inhibit (zero torque command), 2-stage torque limit, CCW/CW run limit switch inputs. |
| | Control output | Alarm status, servo status, servo ready, under torque limit, brake release |
| | Speed command input | Input voltage $-10\text{ V to }+10\text{ V}$ (max speed is reached at $\pm 10\text{ V}$) |
| Internal Velocity | Control input | Servo ON, alarm reset, start 1 (CCW), start 2 (CW), 8-stage speed command 2-stage torque limit |
| | Control output | Alarm status, servo status, servo ready, under torque limit, brake release |
| Smoothing filter | IIR Filter, FIR Filter | |

Torque Control Mode

| Item | Specifications | |
|------------------|----------------------|--|
| Analog Torque | Control input | Servo ON, alarm reset, command input inhibit (zero clamp command) 2-stage torque limit, CCW/CW run inhibit (limit switch inputs) |
| | Control output | Alarm status, servo status, servo ready, under torque limit, brake release |
| | Torque command input | Input voltage, - 10 V to +10 V (max speed is reached at ± 10 V) |
| Smoothing filter | IIR Filter | |

Common Features

| Item | Specifications | |
|---|---|--|
| Speed observer | Available | |
| Auto-tuning | Available | |
| Encoder output Division /Multiplication | Available | |
| Tuning & Function Setup | Available through the Digitax SF setup software "Digitax SF Connect" Tuning with the setup panel on the drive front side | |
| Protective functions | By hardware | Overtoltage, low voltage, Overcurrent, Abnormal temperature, Overload, Encoder error |
| | By software | Overspeed, Position error too high, Parameter errors |
| Alarm Log | Can be referenced with the setup software Digitax SF Connect | |

3. Drive

Notice

*1) In the Drive DA24A □□ (1 kW), single-phase can be used as the AC Supply source. To use single-phase 200 to 240 VAC, connect it to the primary circuit L1 and L3 power connectors.

| Item | | Specifications | |
|------------------|---------------|--|--|
| Drive Model | | DA24A22, DA24A23 | |
| Compatible Motor | | 1kW M □ 102 □ 2 □□ * *) | |
| Voltage Range | | Three-phase 200 to 240 VAC ± 10 % 50/60 Hz | Single-phase 200 to 240 VAC ± 10 % 50/60 Hz |
| AC Supply | Input Current | Rated at 4.5 A (200 VAC input) Rated at 3.8 A (230 VAC input) Up to approximately 13 A | Rated at 8.6 A (200 VAC input) Rated at 7.3 A (230 VAC input) Up to approximately 23 A |

*2) Use SELV (Safety Extra Low Voltage/Non-Hazardous Voltage) power supply with reinforced isolation from hazardous voltage. As a countermeasure against drive failure, install overcurrent protection or use power output capacity of no higher than 100 W.

The current consumption values in the table assume that no I/O signals except the Servo-On signal are connected. Current consumption by all I/O signals in use must be added up.

If multiple drives are to share control power, select a power source that will support the total inrush current of all connected drives.

*3) Braking resistor values do not guarantee optimal performance. If the generated heat becomes too high, increase the resistance value or select a resistor whose allowable power is large enough. Whether or not a braking resistor installation is necessary can be checked on the Setup Panel or Digitax SF Connect

-  3 Preparation
-  5 Setting Parameters

*4) Digitax SF drives are equipped with a software-based emergency stop braking function to stop the equipment. This emergency stop braking function does not necessarily work in case of disconnection from control power such as drive failure and power outage.

An external circuit is required. Please perform thorough testing before actual use.

-  3 Preparation

*5) When mounting drives in an enclosure such as a protection case, install a cooling device, or maintain required clearance around it so that ambient temperature will not rise above the specified temperature.

-  3 Preparation

*6) The minimum time interval varies depending on input format.

-  4 Connections

Overload Detection Feature

Digitax SF drives provide overload protection - overload alarm output and emergency stop upon alarm output -in case of motor operation with load level above the overload detection curve shown below.

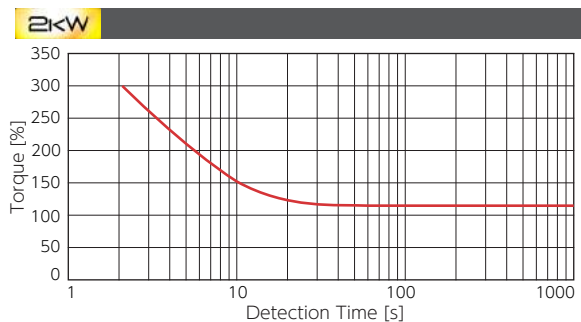
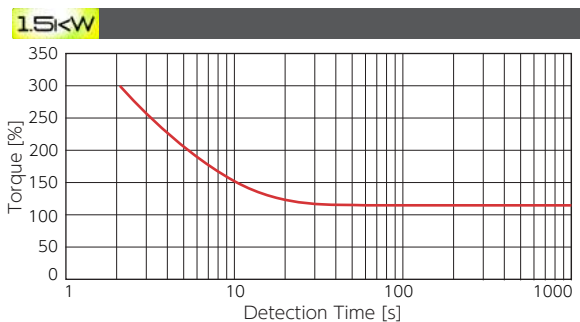
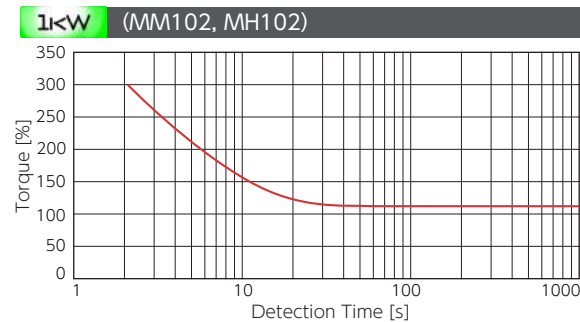
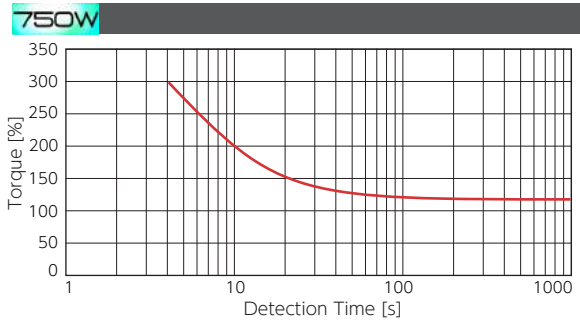
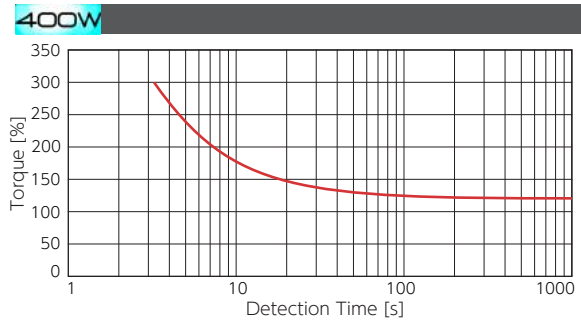
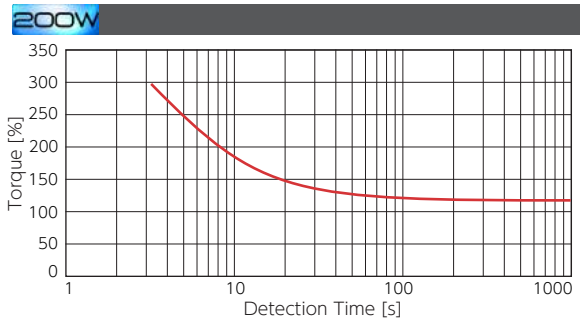
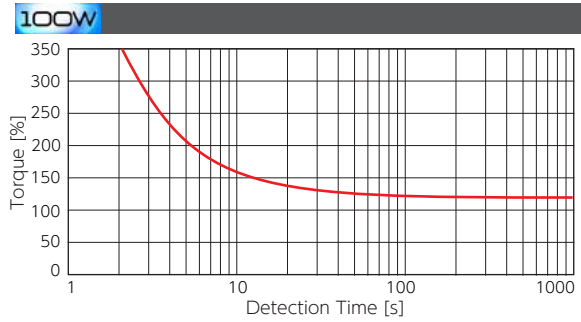
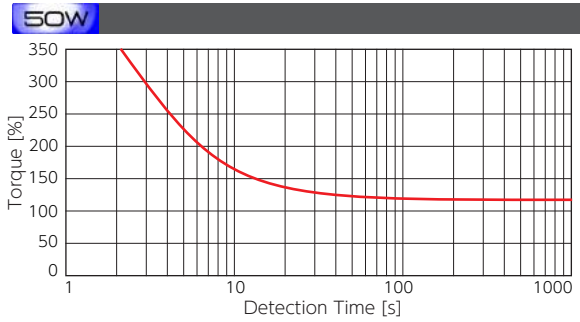

4. Dimensions

Figure 1

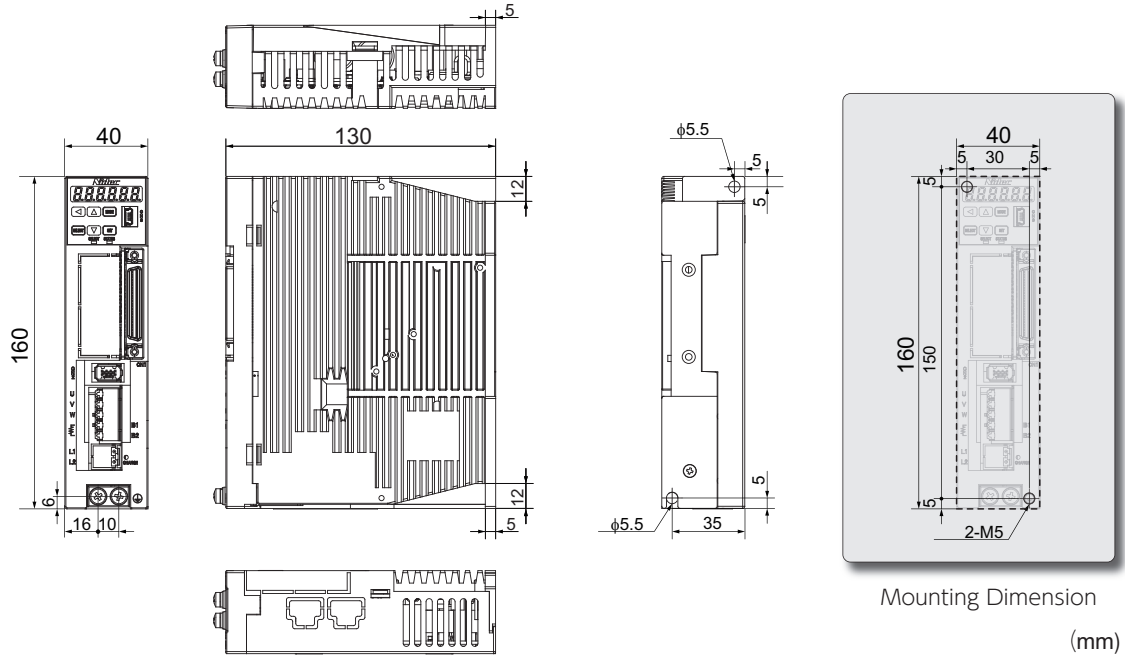

Figure 2

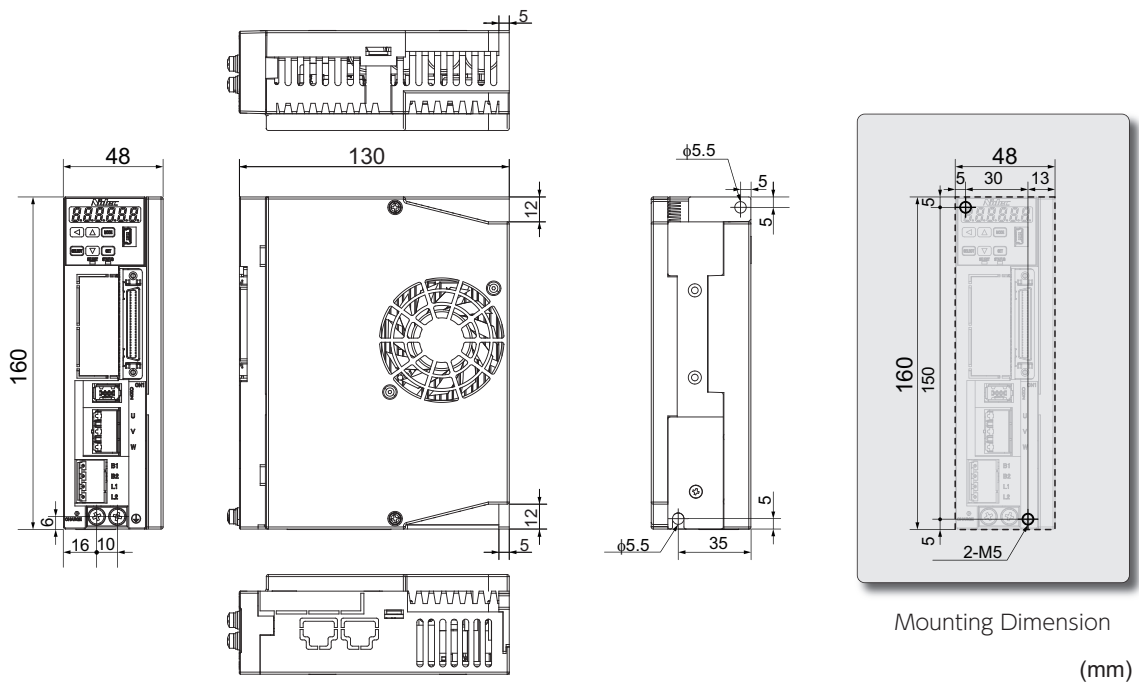

Figure 3

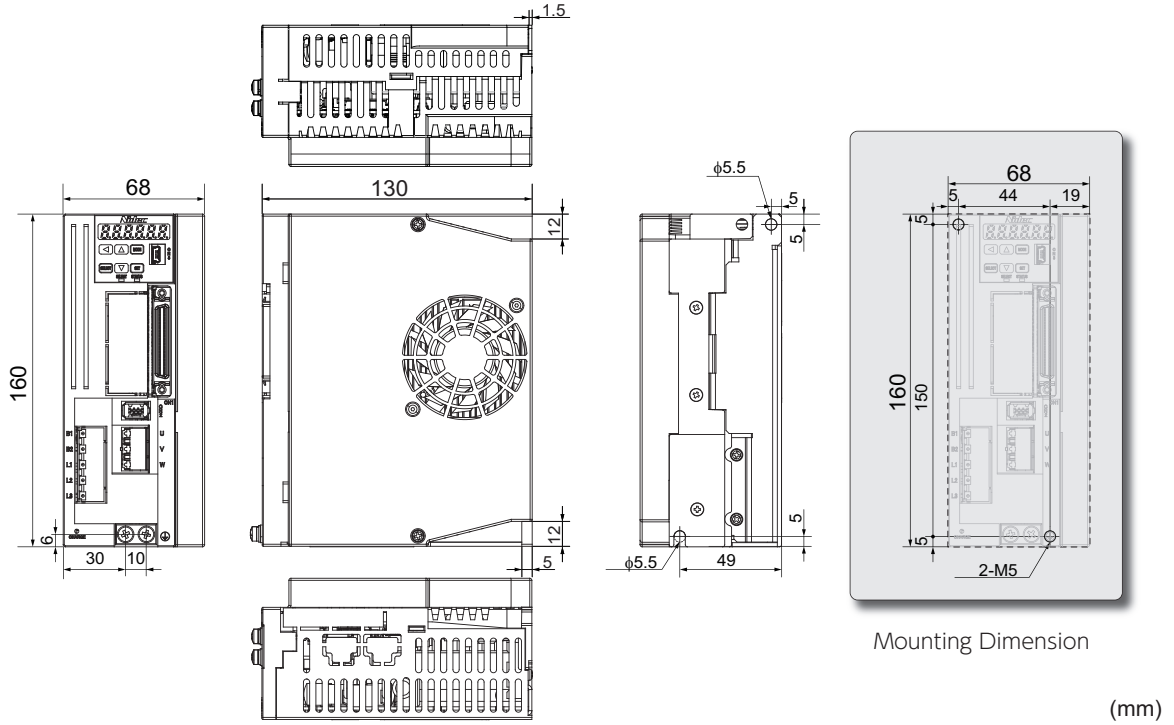
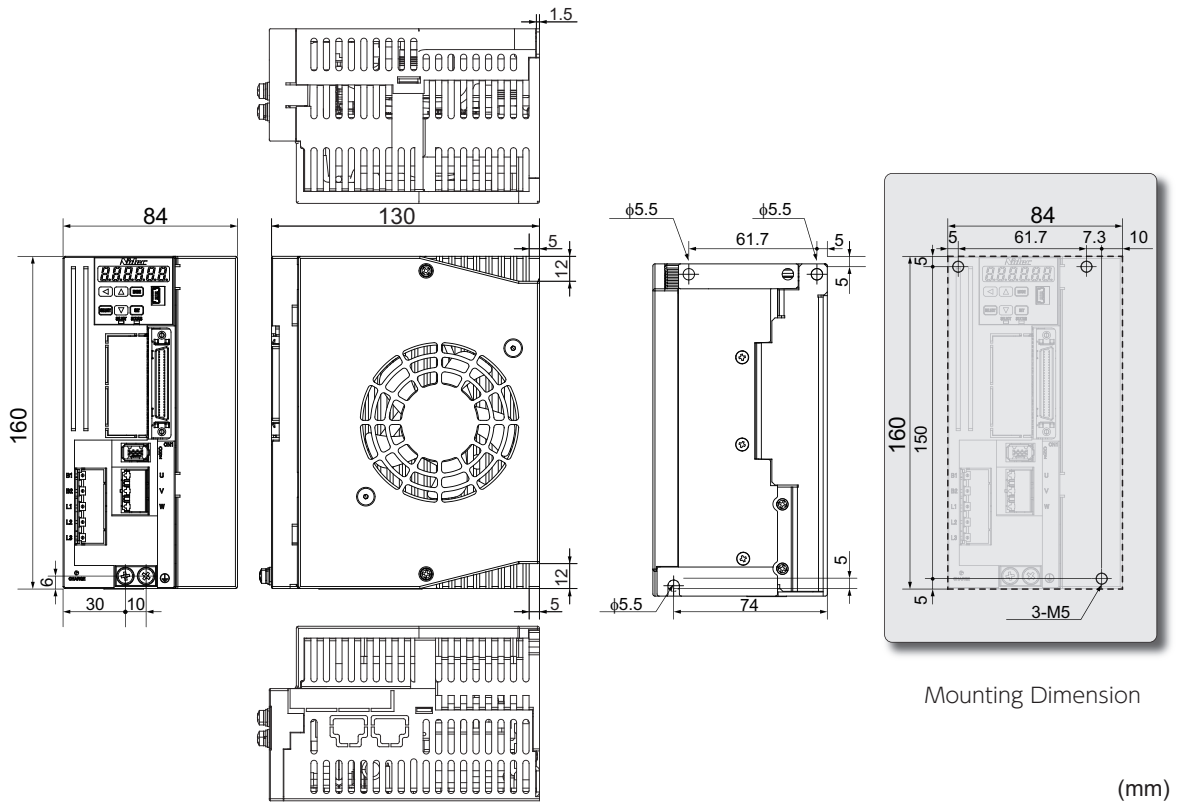



Figure 4



| | |
|---|----|
| 1. Installation | 2 |
| 1. Motor Installation..... | 3 |
| 2. Drive Installation | 5 |
| 2. System Wiring..... | 7 |
| 1. System Wiring..... | 8 |
| 2. Connecting Equipment and Recommended Peripherals | 12 |
| 3. Wiring to the Connectors | 15 |
| Motor Connector Pinout..... | 15 |
| Drive Connectors and Pinouts..... | 17 |
| 4. Accessory Connector..... | 20 |
| 5. Cables..... | 23 |
| 3. Timing Diagrams | 24 |

Installation and Operating Environment



| | | |
|---|--|---|
|  | <p>Ensure that the environment for installation and operation meet the requirements specified in this document.</p> <p>Should you use the product in conditions different from the specifications, please contact us.</p> |  |
|---|--|---|

- Do not install the product where it could be directly exposed to direct sunlight.
- Be sure to install each drive inside a control panel.
- Install the product in an environment free from humidity and ingress of water and oil such as cutting oil and oil mist.
- Never use the product in an **environment containing** explosive or flammable gases, chloride, acidic or alkaline corrosive environment such as sulfur dioxide, chlorine, ammonia and so on.
- Use the product in an environment free from dust, iron dust, and chips.
- Do not use the product near locations exposed to high temperatures, continuous vibrations, or excessive shock.

Precautions

- The control power and the host control device must share one power supply (24 VDC).
- When performing maintenance, be sure to **isolate all power supplies beforehand.**
- Be aware of the residual voltage in the drive remaining for 5 minutes after the main power shut off. The drive of 750 W or more has a cooling fan on the right side.
Do not touch or block the air vent of the drive. Do not place objects which would block the air vent.

Dust-proof and Waterproof

| | | |
|---|--|---|
|  | <p>Drives are not waterproof.</p> |  |
|---|--|---|

The protective enclosure rating of motors depends on the rated output.

| | |
|--------------|--------|
| 50 W to 1 kW | : IP65 |
| 1 kW to 2 kW | : IP67 |

(except for the shaft output component and the connectors)

1. Installation

1. Motor Installation



Do not use any other screws but those in the recommended sizes.

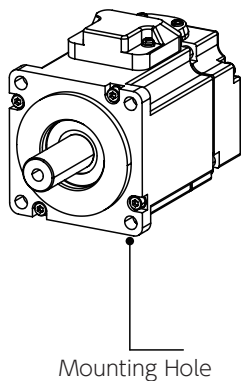

Motor Mounting Screws

| Motor Model | Mounting Hole Diameter | Recommended Size |
|--|------------------------|---|
| MM500, MY500 MM101, MY101 | 2- \varnothing 4.5 | M4 \times 12 mm or more Hexagon socket head bolt |
| MA201, MH201, MX201, MZ201 MA401, MH401, MX401, MZ401 | 4- \varnothing 5.5 | M5 \times 12 mm or more Hexagon socket head bolt |
| MA751, MH751, MX751, MZ751 | 4- \varnothing 6.6 | M6 \times 14 mm or more Hexagon socket head bolt |
| MM102, MH102, MM152, MH152, MM202 | 4- \varnothing 9 | M8 \times 18 mm or more Hexagon socket head bolt |

Installation Precautions

Never remove the encoder from the motor or disassemble the motor.

The motor shaft has anti-rust oil applied at the time of shipment. Before installing the motor, wipe off the oil completely. Perform precise axis alignments. Otherwise, the motor operation will cause vibration or result in shorter service life of the motor.

Shock and Impact Force

When transporting, installing or removing the motor, do not apply excessive impact force or load.

Do not hold the encoder unit, cables, or connectors when carrying the motor.

Shock resistance of the motor is 200 m/s² (20 g) or less.

During installation or operation, radial load or axial load applied to each motor has to be within the withstand rating.

When attaching a coupling to the motor shaft end or removing it, avoid direct impact by a tool such as hammer.

To remove the pulley, coupling, or any other parts from the shaft, use a puller.

Connection with Machines

Use a coupling to absorb angle and direction deviations so that the motor shaft load will be less than the rated allowable axial load.

Otherwise, the bearing life in the motor will be shorter, or the shaft may become damaged.

If you are using a rigid coupling, install it very carefully such that the axial misalignment will be minimal. (Using a flexible coupling is recommended.)

Countermeasure for Oil and Water

Do not use any cable immersed in water or oil.

Install the motor such that the cable side is facing downward.

Do not use the motor in an environment where it will be constantly subjected to oil or water splash.

In the case that a speed reducer is to be connected to a motor **and it is to be located above** the motor shaft, use an oil-sealed motor so that no oil from the speed reducer permeates into the motor.

Types of Mounting and Oil Seal

Digitax SF motors can be mounted in two different ways, horizontally and vertically. Observe the following precautions for motor installation.

Horizontal Installation

To protect the motor from oil or water, have the cable-pull side downward.

Vertical Installation

If a speed reducer is connected to a motor such that it will be located **above** the motor shaft, use an oil-sealed motor so that no oil from the speed reducer permeates into the motor.

Stress to the Cables

Be careful not to apply stress, such as excessive bending or motor weight, to the cable-pull part or its connecting section.

If the the motor is attached to mounting machinery, be sure to use a flexible cable.

When placing the cable in a cableveyor, minimize the bending stress to the cable.

Bending radii of the motor power cable must be more than R20 mm.

3. Preparation

1. Installation

2. Drive Installation



Do not turn on the AC Supply or the control power until all wiring work is completed.



Mounting Orientation and Clearance



When installing drives, maintain required clearances for protective enclosures and control panels for heat dissipation and air flow.

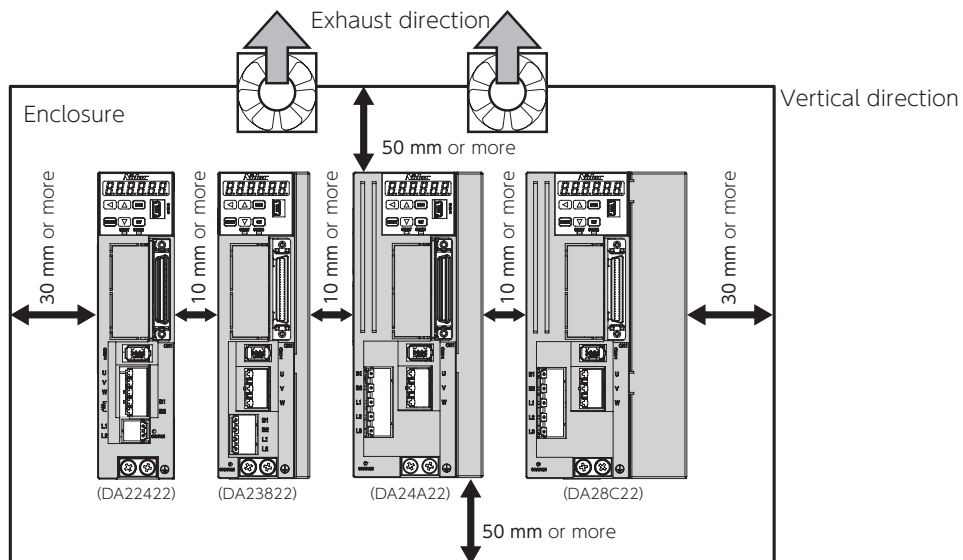

- Install all drives vertically. Use M5 screws at two locations to mount 50 W to 750 W drives and three locations to mount 1 kW to 2 kW drives.

 2 Specifications: Drive Dimensions

- If you are mounting the drive into an enclosure such as protective casing, use a fan or air conditioner so that the ambient temperature inside will not exceed 50 °C.
- The temperature of the heat sink at its surface may become 30 °C (or more) higher than the ambient temperature.
- Use heat resistant wiring materials and keep drives away from heat-sensitive equipment and wiring.
- The service life of each drive depends on the ambient temperatures of the internal electrolytic capacitor. Electrolytic capacitors last approximately 5 to 6 years under the conditions of 30 °C annual average temperature, 80 % load factor, and 20 hours or less average daily operation.

Mounting Drives



Be sure to mount each drive on a conductive surface such as aluminum brushed plate.

Hook the U-shaped installation notch of the drive to the bolt that has been screwed in advance.

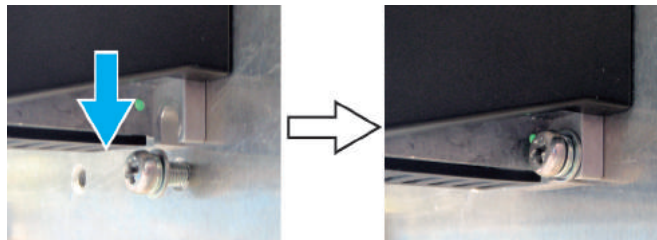

Tighten the mounting screws on the drive top.



Loosely screw all drives to the chassis first, and then securely tighten them all together. (Tightening torque: 1.4 to 1.6 N·m)



DANGER



Be mindful when wiring and handling high voltage materials



Earth / Ground connection is a must.

Ensure the incoming supply to the power supply providing the control 24V supply is from the same source as the AC Supply

Do not use the AC supply contactor (installed on the AC Supply side) to run or stop the motor.

Do not install a switch between the control power supply and the drive. Install the switch on the primary input side of the control power supply.

For high-voltage cables, use wires of 600V withstand voltage or more.

For a CN1 connector cable, use a shielded twisted-pair cable of 2 m or less.

The encoder cable length must be 20 m or less.

For stranded wire, use insulation coating, rod or ring crimp terminals.

Wiring pattern 1

50W 100W 200W 400W 750W 1kW 1.5kW 2kW

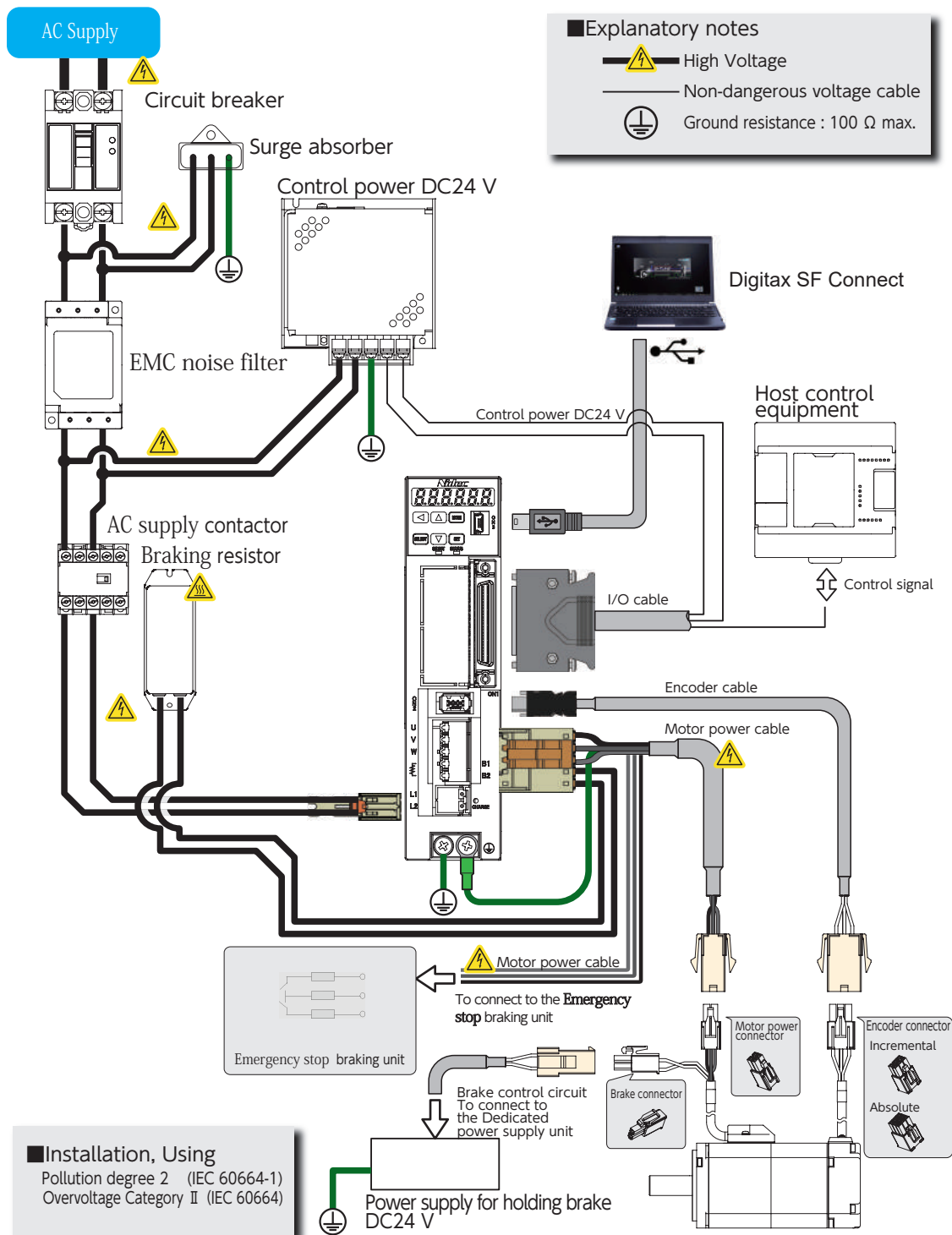

For compliance with the stated EMC radio frequency emission standard the following conditions must be met:

- The specified filter must be used.
- The filter and the drive must be mounted close together on the same metal plate, ensuring direct metallic contact with the plate (the plate must have a conductive surface, not painted or anodised). The connections between the filter and drive must be as short as practicable.
- The screen (shield) of the motor cable must be fixed in direct contact with the same plate. The contact must be by direct contact, no wire or “pigtail” is permitted.
- The specified ferrite core must be fitted to the signal cable(s).
- For compliance with the stated surge immunity standard the specified surge absorber must be fitted as shown in the wiring diagrams

2. System Wiring

Wiring Pattern 2

50W

100W

200W

400W

750W

1kW

1.5kW

2kW

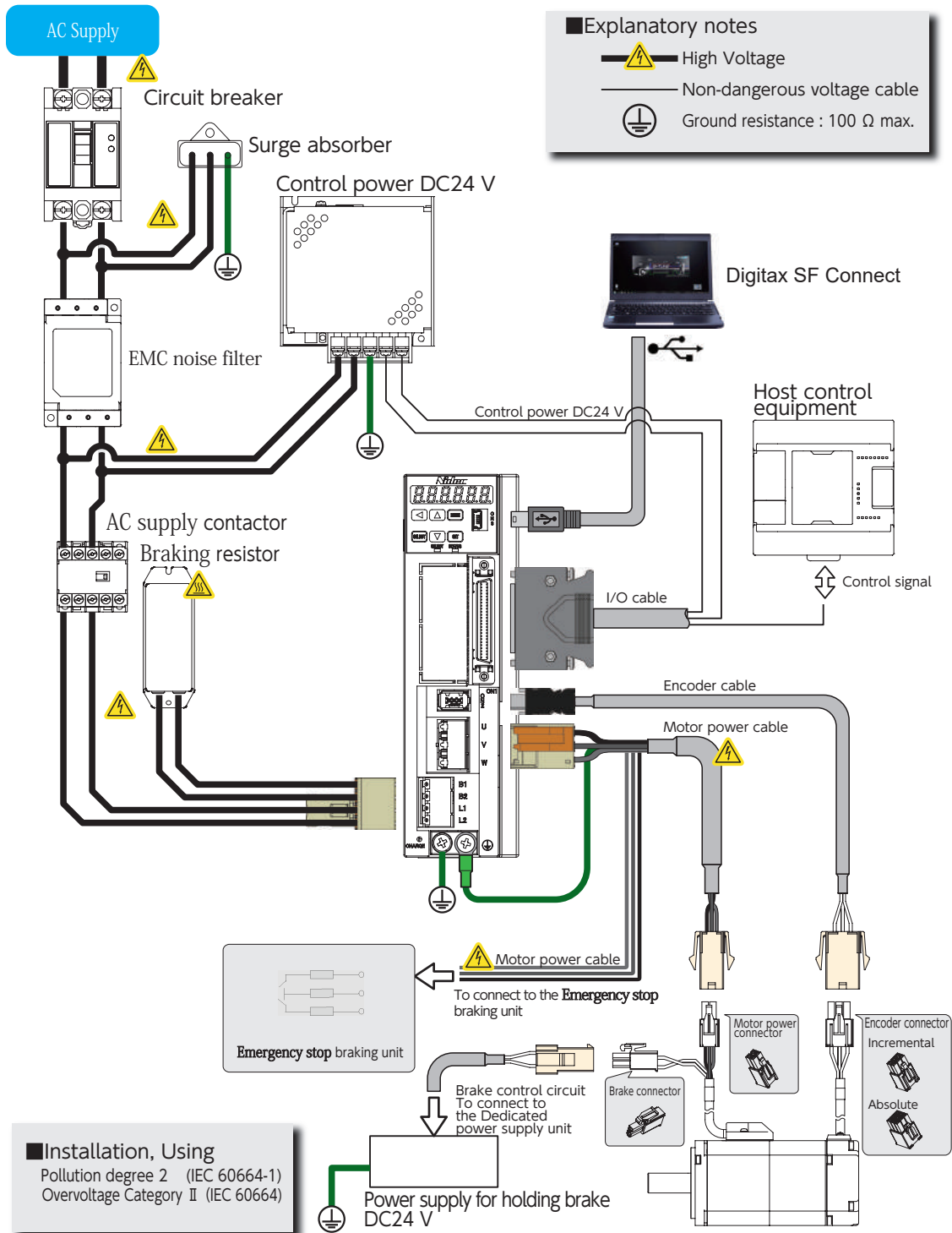

For compliance with the stated EMC radio frequency emission standard the following conditions must be met:

- The specified filter must be used.
- The filter and the drive must be mounted close together on the same metal plate, ensuring direct metallic contact with the plate (the plate must have a conductive surface, not painted or anodised). The connections between the filter and drive must be as short as practicable.
- The screen (shield) of the motor cable must be fixed in direct contact with the same plate. The contact must be by direct contact, no wire or "pigtail" is permitted.
- The specified ferrite core must be fitted to the signal cable(s).
- For compliance with the stated surge immunity standard the specified surge absorber must be fitted as shown in the wiring diagrams

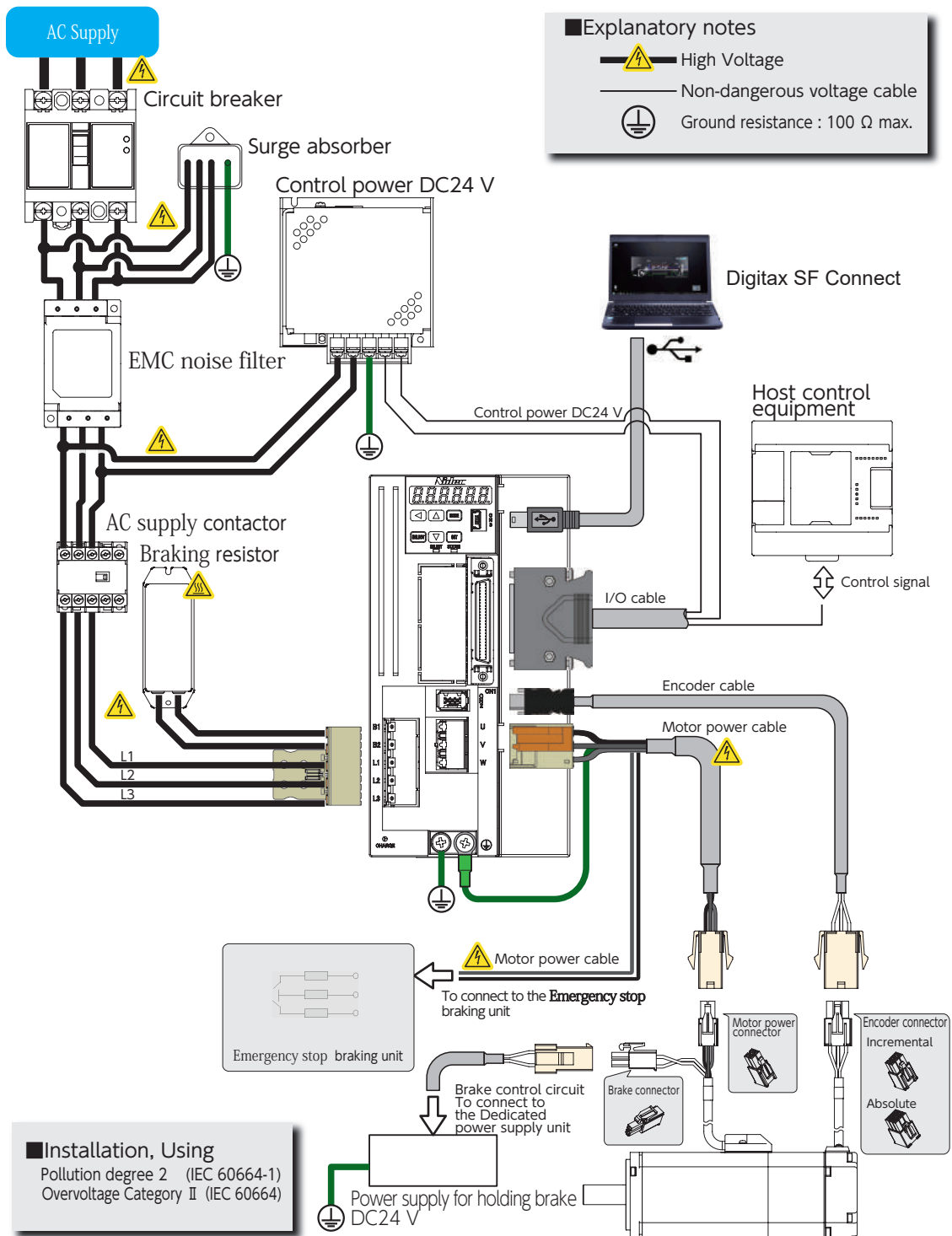

For compliance with the stated EMC radio frequency emission standard the following conditions must be met:

- The specified filter must be used.
- The filter and the drive must be mounted close together on the same metal plate, ensuring direct metallic contact with the plate (the plate must have a conductive surface, not painted or anodised). The connections between the filter and drive must be as short as practicable.
- The screen (shield) of the motor cable must be fixed in direct contact with the same plate. The contact must be by direct contact, no wire or "pigtail" is permitted.
- The specified ferrite core must be fitted to the signal cable(s).
- For compliance with the stated surge immunity standard the specified surge absorber must be fitted as shown in the wiring diagrams

2. System Wiring

Wiring Pattern 4

50W

100W

200W

400W

750W

1kW

1.5kW

2kW

(MM102 & MH102)

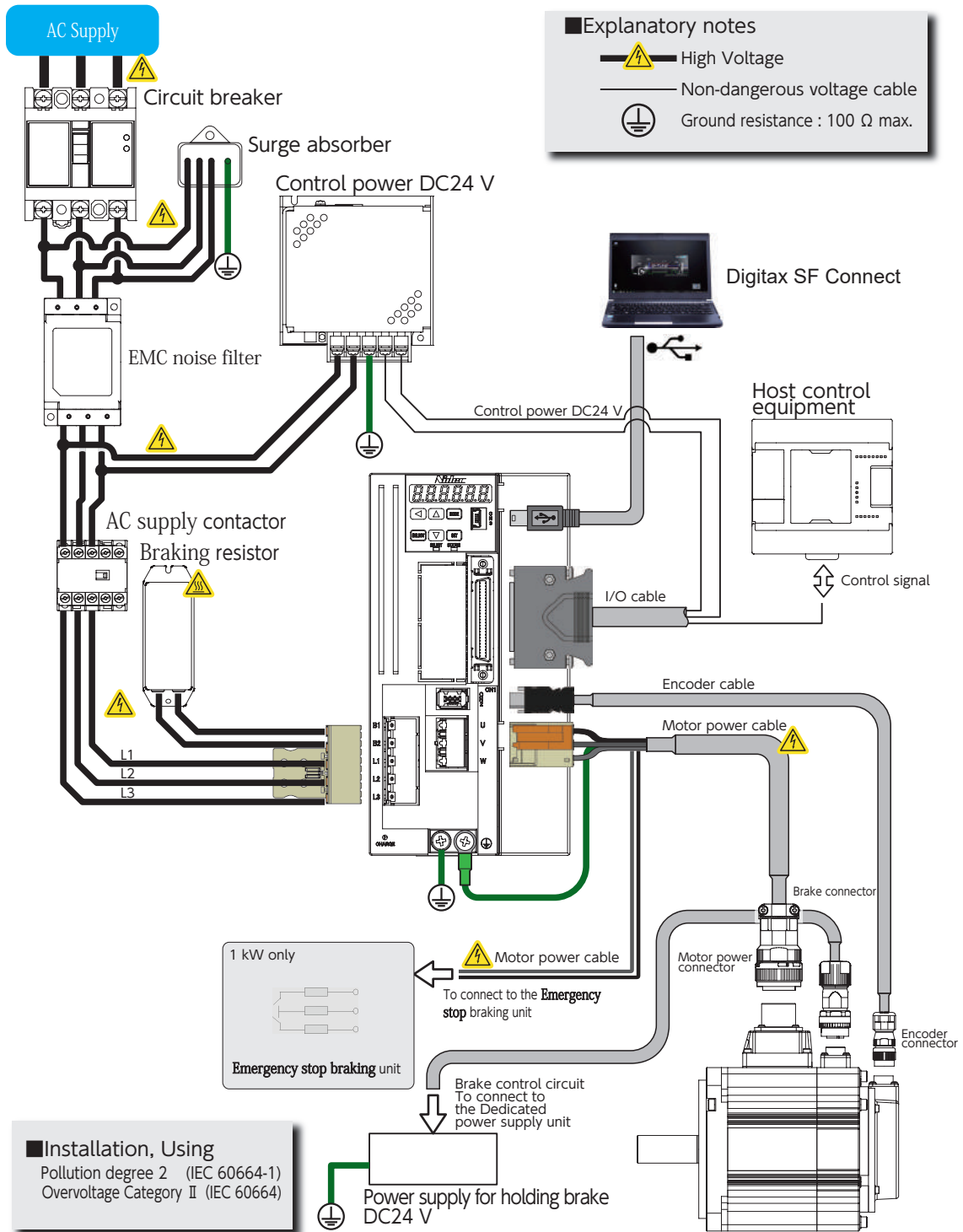

For compliance with the stated EMC radio frequency emission standard the following conditions must be met:

- The specified filter must be used.
- The filter and the drive must be mounted close together on the same metal plate, ensuring direct metallic contact with the plate (the plate must have a conductive surface, not painted or anodised). The connections between the filter and drive must be as short as practicable.
- The screen (shield) of the motor cable must be fixed in direct contact with the same plate. The contact must be by direct contact, no wire or "pigtail" is permitted.
- The specified ferrite core must be fitted to the signal cable(s).
- For compliance with the stated surge immunity standard the specified surge absorber must be fitted as shown in the wiring diagrams

2. System Wiring

2. Connecting Equipment and Recommended Peripherals

AC Supply

Please use this product in the power supply environment of Over-Voltage Category II defined by IEC60664-1. This is the AC Supply for drives.

50 W to 750 W Drives : Single-phase AC200 V -10 % to AC240 V +10 %

1 kW to 2 kW Drives : Three-phase AC200 V -10 % to AC240 V +10 %

Using an overvoltage protection relay is recommended.

When having single-phase power wired to a 1 kW drive, wire the primary circuit AC200 V between the L1 and L3 terminals of the drive.

To avoid unbalance of the three-phase AC200 V wiring in your factory, we recommend that you consider balance of current in your three-phase wirings.

Confirm that your contract with the electric power company is not limited to use of three-phase.

Control power

This is power supply of DC24 V \pm 10 % for drive control power, I/O power and motor brake release power.

Use a SELV (Safety Extra Low Voltage) power supply with reinforced insulation against hazardous voltages. Be sure to connect a varistor to the motor brake release power supply.

Cables (*)

Use of UL wires and cables suitable for motor rated output are recommended.

High-voltage cables and Ground/Earth FG cables:

AWG18 / 600 V breakdown voltage or equivalent for 50 W to 750 W

AWG14 / 600 V breakdown voltage or equivalent for 1 kW to 2 kW

Motor power cables:

AWG18 / 300 V breakdown voltage or equivalent for 50 W to 750 W

AWG14 / 300 V breakdown voltage or equivalent for 1 kW to 2 kW

Encoder cables:

AWG22 and AWG24 compound / 30 V breakdown voltage or equivalent

Shielded cables with twisted pair wires

Length not exceeding 20 m

User I/O cable:

AWG26 / 300 V breakdown voltage or equivalent

Shielded cables with twisted pair wires

Length not exceeding 2 m

*) Should you use a cable longer than the specification, please contact us in advance.

Circuit breaker

To protect the power supply line, circuit breakers shut the circuit down in the event of over-current. Be sure to use an IEC standard and UL-certified circuit breaker between the power supply and the EMC noise filter. To ensure compliance with EMC, use an earth leakage circuit breaker that we recommend.

| | | |
|---------------------|----------------------|---|
| Recommended Product | Fuji Electric Co Ltd | Single-phase : EW32AAG-2P020B Three-phase : EW32AAG-3P020B |
|---------------------|----------------------|---|

20 A for single-phase (three-phase) 200 V

Leakage current of 30 mA. An equivalent product is acceptable

Select the capacity and other characteristics according to your entire system configuration.

2. System Wiring

EMC noise filter

EMC filters prevent emission of electromagnetic interference onto the AC supply lines. To ensure compliance with EMC, use the recommended EMC noise filter.

| | | |
|---------------------|----------------------------------|---|
| Recommended Product | OKAYA Electric Industries Co Ltd | Single-phase : 4200-0056 Three-phase : 4200-3106 |
|---------------------|----------------------------------|---|

Included in Digitax SF drive's EMC testing.

Select the capacity and other characteristics according to your entire system configuration.

AC supply contactor

This is an on/off switch for the main power supply. Use a surge absorber on the input side of the AC supply.

| | | |
|---------------------|----------------------|-----------|
| Recommended Product | Fuji Electric Co Ltd | SK06G-E10 |
|---------------------|----------------------|-----------|

An equivalent product is acceptable.

Select the capacity and other characteristics according to your entire system configuration.

Surge absorber

To ensure compliance with EMC, connect the recommended surge absorber to the primary side of the AC supply.

| | | |
|---------------------|----------------------------------|---|
| Recommended Product | OKAYA Electric Industries Co Ltd | Single-phase : 2490-2754 Three-phase : 2490-0004 |
|---------------------|----------------------------------|---|

Included in Digitax SF drive's EMC testing

Signal line EMC noise filter/ferrite core

To ensure compliance with EMC, use the recommended signal line EMC noise filter/ferrite core.

| | | |
|---------------------|---|---|
| Recommended Product | SEIWA ELECTRIC MFG. CO., LTD. (Misumi Corporation) | E04SR401938 (ATCK-1130) https://uk.misumi-ec.com/ |
|---------------------|---|---|

Included in Digitax SF drive's EMC testing

Braking resistor

This product is not equipped with a braking resistor. If the smoothing capacitor inside the servo drive cannot absorb the system regenerative power, an external braking resistor is required. As a guideline, check the regeneration state on the settings panel, and use a braking resistor if the regenerative voltage warning is ON. Build an overheating prevention circuit using a resistor which has built-in thermostat. If the temperature of generated heat becomes high, you can suppress the heat by installing a cooling device, or selecting a resistor whose allowable power is 5 to 10 times larger than regenerative voltage.

| | | |
|---------------------|------------------------|---|
| Recommended Product | Chiba Techno Co., Ltd. | For 50 W to 750 W : CAN100S 47 Ω J 100W For 1 kW, 1.5 kW : CAN400S 30 Ω J 400 W For 2 kW : CAN750S 20 Ω J 750 W |
|---------------------|------------------------|---|

When considering a braking resistor other than the recommended above, use the following as a guideline.

| Drive Model | DA2YZ22 | DA2Z122 | DA21222 | DA22422 | DA23822 | DA24A22 | DA26B22 | DA28C22 |
|------------------------------|----------------|---------|---------|---------|---------|----------------|---------|------------------|
| Compatible Motor | M□ 500 | M□ 101 | M□ 201 | M□ 401 | M□ 751 | M□ 102 | M□ 152 | MM202 |
| Rated output | 50 W | 100 W | 200 W | 400 W | 750 W | 1 kW | 1.5 kW | 2 kW |
| Regeneration Resistance | 40 Ω to 50 Ω | | | | | 30 Ω | | 20 Ω |
| Allowable regeneration power | 20 W | | | | | 40 W | | 60 W |
| Recommended Wattage | 100 W to 200 W | | | | | 400 W to 800 W | | 600 W to 1,200 W |

The braking resistor values do not guarantee the optimal performance. Regeneration allowable voltages above are minimum values as a point of reference.

The braking resistor may become very hot. It requires sufficient margin of regeneration allowable power.

2. System Wiring

Emergency stop brake

This product is **not** equipped with a emergency stop brake

Use the following circuit example when building a emergency stop brake circuit.

Select a cement resistor of 6.8 Ω 10 W.

Select coil surge protection relays with diode.

For wiring with the motor power line, UL wires (AWG18 / 600 V or equivalent) are recommended.

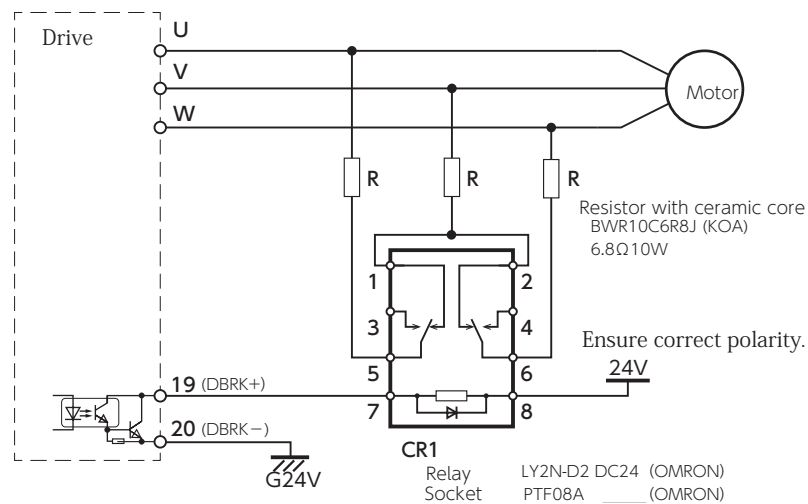

To build a emergency stop brake circuit, please use our recommended products listed below.

| | Device | Manufacturer | Model Code |
|---------------------|----------------------------|--------------|---------------|
| Recommended Product | Relay | OMRON | LY2N-D2 DC24V |
| | Relay socket | OMRON | PTF08A |
| | Resistor with ceramic core | KOA | BWR10C6R8J |

Grounding

Since this product is Class I device, protective grounding is mandatory. (Type D grounding: grounding resistance of up to 100 Ω)

Properly ground the product using protective grounding terminals through EMC-compatible casing and control panel.

2. System Wiring

3.Wiring to the Connectors

Motor Connector Pinout

Motor

50W

100W

200W

400W

750W

1kW

1.5kW

2kW

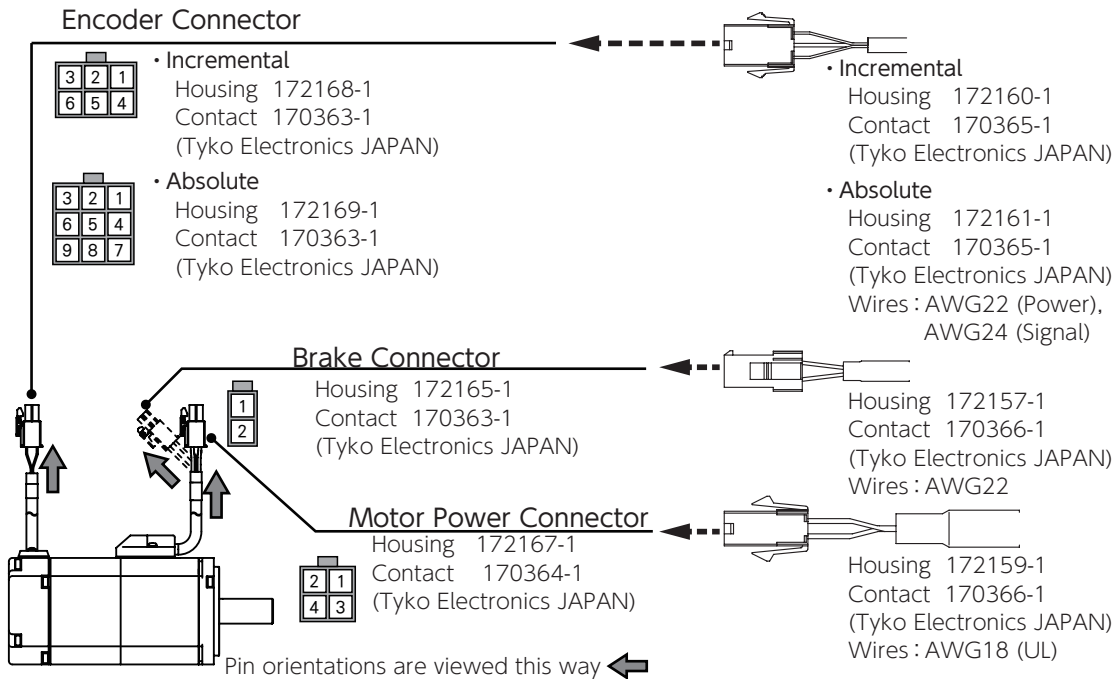

| Name | Pin No. | Signal | Description |
|-----------------------|---------|--------|----------------------------------|
| Motor Power | 1 | U | Motor power U-phase |
| | 2 | V | Motor power V-phase |
| | 3 | W | Motor power W-phase |
| | 4 | FG | Motor frame ground |
| Brake ^{(*)1} | 1 | BRK + | Brake power supply DC24 V |
| | 2 | BRK - | Brake power supply GND |
| Encoder (Incremental) | 1 | - | (No Connect) |
| | 2 | +D | Serial communication data + Data |
| | 3 | -D | Serial communication data - Data |
| | 4 | VCC | Encoder power supply +5 V |
| | 5 | SG | Signal ground |
| | 6 | SHIELD | Shield |
| Encoder (Absolute) | 1 | BAT | External battery ^{(*)2} |
| | 2 | - | (No Connect) |
| | 3 | SHIELD | Shield |
| | 4 | +D | Serial communication data + Data |
| | 5 | -D | Serial communication data - Data |
| | 6 | - | (No Connect) |
| | 7 | VCC | Encoder power supply +5 V |
| | 8 | SG | Signal ground |
| | 9 | - | (No Connect) |

*1) Only for a motor equipped with a brake

*2) Connect the negative pole of the battery to SG (Signal Ground).

2. System Wiring

Motor 50W 100W 200W 400W 750W 1kW 1.5kW 2kW
(MM102 & MH102)

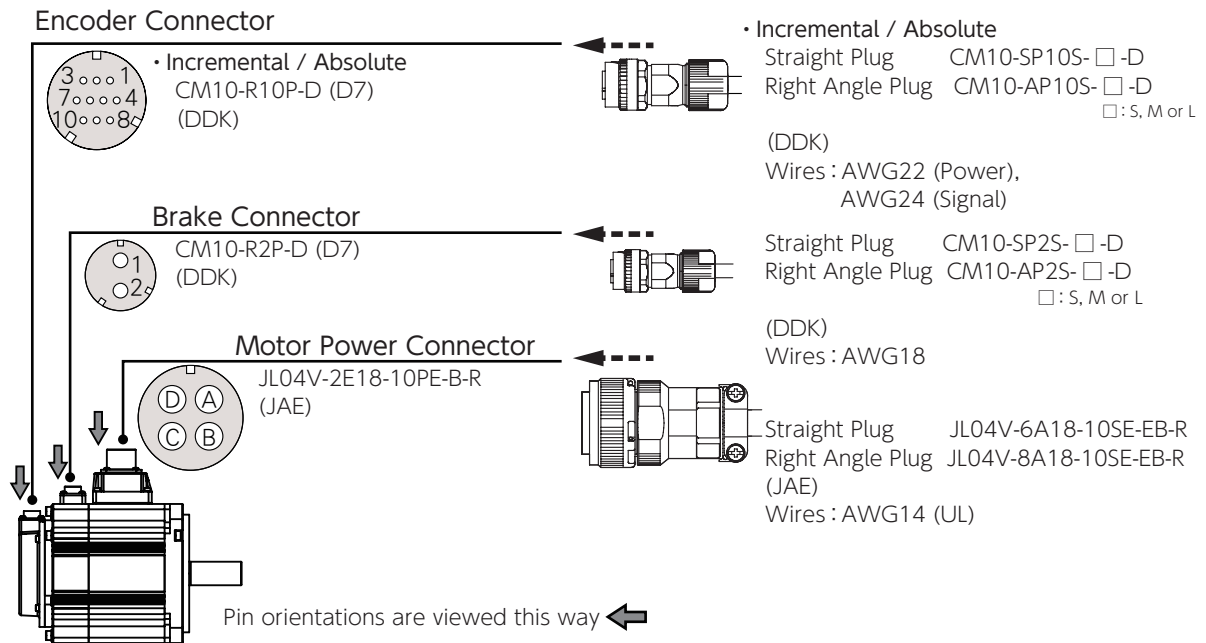

| Name | Pin No. | Signal | Description |
|--------------------------|---------|--------|----------------------------------|
| Motor Power | A | U | Motor power U-phase |
| | B | V | Motor power V-phase |
| | C | W | Motor power W-phase |
| | D | FG | Motor frame ground |
| Brake ^{(*)1} | 1 | BRK + | Brake power supply DC24 V |
| | 2 | BRK - | Brake power supply GND |
| Encoder (Incremental) | 1 | VCC | Encoder power supply +5 V |
| | 2 | SG | Signal ground |
| | 3, 4 | - | (No Connect) |
| | 5 | +D | Serial communication data + Data |
| | 6 | -D | Serial communication data - Data |
| | 7, 8, 9 | - | (No Connect) |
| | 10 | SHIELD | Shield |
| Encoder (Absolute) | 1 | VCC | Encoder power supply +5 V |
| | 2 | SG | Signal ground |
| | 3 | - | (No Connect) |
| | 4 | BAT | External battery ^{(*)2} |
| | 5 | +D | Serial communication data + Data |
| | 6 | -D | Serial communication data - Data |
| | 7, 8 | - | (No Connect) |
| | 9 | SG | Signal ground |
| 10 | SHIELD | Shield | |

*1) Only for a motor equipped with a brake
 *2) Connect the negative pole of the battery to SG (Signal Ground).

2. System Wiring

Drive Connectors and Pinouts

Drive

50W

100W

200W

400W

750W

1kW

1.5kW

2kW

PC Communication Connector

UC60SC-MB-5ST
(Hirose Electric)



USB mini B

User I/O Connector

DF02R050NA1 (JAE)

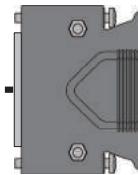

Plug 10150-3000-PE (3M)
Cover 10350 (3M)
or Equivalent alternatives
Wires : AWG26

Encoder Connector

3E106-2230KV (3M)



Connector 3E206-0100KV (3M)
Cover 3E306-3200-008 (3M)
Wires : AWG22 (Power), AWG24 (Signal)

Motor Power Connector

2092-1325 (WAGO JAPAN)

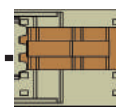

Accessories
2092-1525/002-000 (WAGO JAPAN)
Wires : AWG18 (UL)

AC Supply Power Connector

2092-1422 (WAGO JAPAN)



Accessories
2092-1102/002-000 (WAGO JAPAN)
Wires : AWG18 (UL)

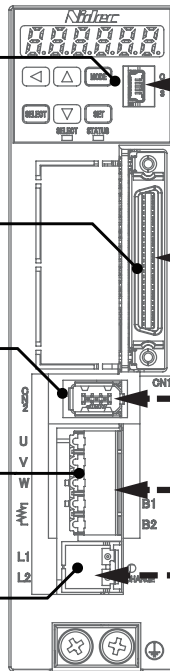

| Name | Code | Pin No. | Signal | Description |
|------------------|------------|--|--------|--------------------------------------|
| AC Supply | L1L2 | 1 | L1 | AC Supply power cable 1 |
| | | 2 | L2 | AC Supply power cable 2 |
| Motor Power | UVW / B1B2 | 1 | U | Motor power U-phase |
| | | 2 | V | Motor power V-phase |
| | | 3 | W | Motor power W-phase |
| | | 4 | B1 | Braking resistor connection (+) |
| | | 5 | B2 | Braking resistor connection (-) |
| Encoder | CN2 | 1 | VCC | Encoder power supply +5 V |
| | | 2 | GND | Signal ground |
| | | 3, 4 | - | (No Connect) |
| | | 5 | +D | Serial communication data + Data |
| | | 6 | -D | Serial communication data - Data |
| | | - | FG | SHIELD wired to the connector casing |
| PC Communication | CN3 | 1 | VBUS | USB power supply +5 V |
| | | 2 | D- | USB data - |
| | | 3 | D+ | USB data + |
| | | 4 | - | (No Connect) |
| | | 5 | GND | USB signal ground |
| User I/O | CN1 | Route power and signal wiring suitable for your operation mode. (See "Example of I/O Wiring") | | |

2. System Wiring

Drive

50W 100W 200W 400W **750W** 1kW 1.5kW 2kW

PC Communication Connector

UC60SC-MB-5ST
(Hirose Electric)

USB mini B

User I/O Connector

DF02R050NA1 (JAE)

Plug 10150-3000-PE (3M)
Cover 10350 (3M)
or Equivalent alternatives
Wires : AWG26

Encoder Connector

3E106-2230KV (3M)

Connector 3E206-0100KV (3M)
Cover 3E306-3200-008 (3M)
Wires : AWG22 (Power), AWG24 (Signal)

Motor Power Connector

2092-3323 (WAGO JAPAN)

Accessories
2092-3523/002-000 (WAGO JAPAN)
Wires : AWG18 (UL)

AC Supply Power Connector

2092-1424 (WAGO JAPAN)

Accessories
2092-1104/002-000 (WAGO JAPAN)
Wires : AWG18 (UL)

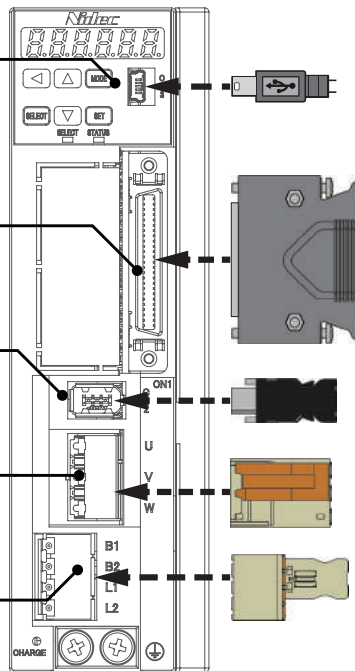

| Name | Code | Pin No. | Signal | Description |
|------------------|-------------|--|--------|--------------------------------------|
| AC Supply | L1L2 / B1B2 | 1 | B1 | Braking resistor connection (+) |
| | | 2 | B2 | Braking resistor connection (-) |
| | | 3 | L1 | AC Supply power cable 1 |
| | | 4 | L2 | AC Supply power cable 2 |
| Motor Power | UVW | 1 | U | Motor power U-phase |
| | | 2 | V | Motor power V-phase |
| | | 3 | W | Motor power W-phase |
| Encoder | CN2 | 1 | VCC | Encoder power supply +5 V |
| | | 2 | GND | Signal ground |
| | | 3, 4 | - | (No Connect) |
| | | 5 | +D | Serial communication data + Data |
| | | 6 | -D | Serial communication data - Data |
| | | - | FG | SHIELD wired to the connector casing |
| PC Communication | CN3 | 1 | VBUS | USB power supply +5 V |
| | | 2 | D- | USB data - |
| | | 3 | D+ | USB data + |
| | | 4 | - | (No Connect) |
| | | 5 | GND | USB signal ground |
| User I/O | CN1 | Route power and signal wiring suitable for your operation mode. (See "Example of I/O Wiring") | | |

2. System Wiring

Drive

50W 100W 200W 400W 750W **1kW** 1.5kW 2kW

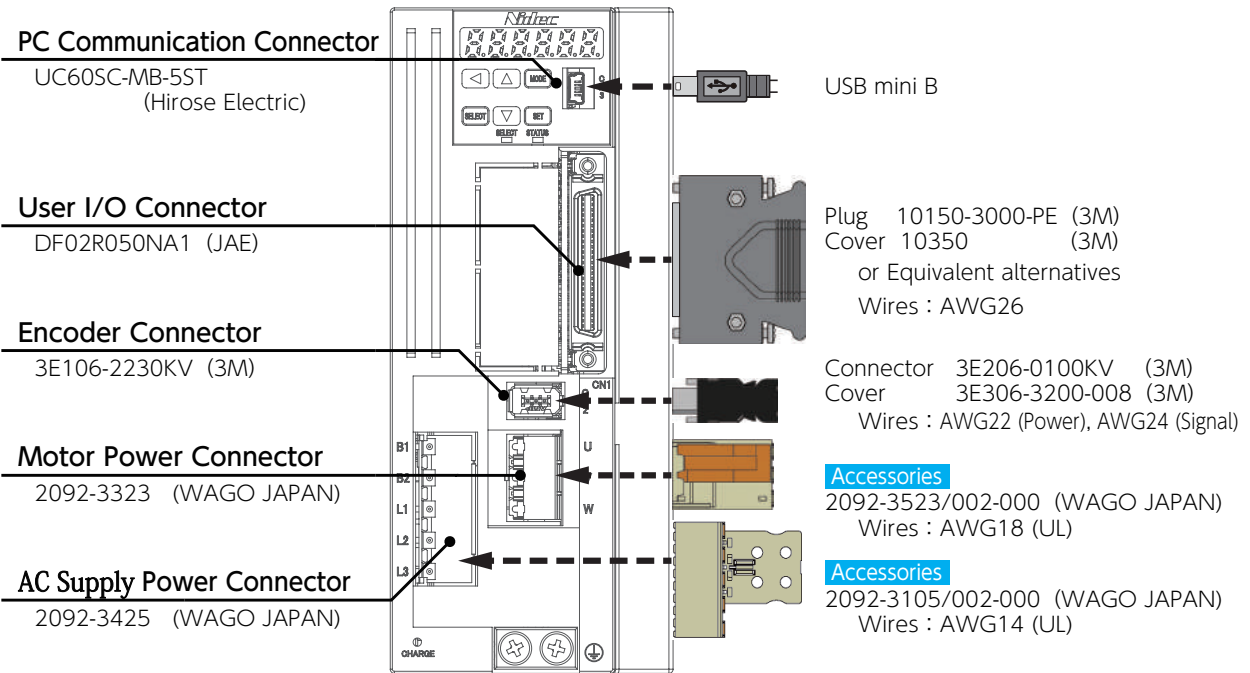

| Name | Code | Pin No. | Signal | Description |
|------------------|---------------|--|--------|---|
| AC Supply | L1L2L3 / B1B2 | 1 | B1 | Braking resistor connection (+) |
| | | 2 | B2 | Braking resistor connection (-) |
| | | 3 | L1 | AC Supply power cable 1 ^{(*)1} |
| | | 4 | L2 | AC Supply power cable 2 ^{(*)2} |
| | | 5 | L3 | AC Supply power cable 3 ^{(*)1} |
| Motor Power | UVW | 1 | U | Motor power U-phase |
| | | 2 | V | Motor power V-phase |
| | | 3 | W | Motor power W-phase |
| Encoder | CN2 | 1 | VCC | Encoder power supply +5 V |
| | | 2 | GND | Signal ground |
| | | 3, 4 | - | (No Connect) |
| | | 5 | +D | Serial communication data + Data |
| | | 6 | -D | Serial communication data - Data |
| | | - | FG | SHIELD wired to the connector casing |
| PC Communication | CN3 | 1 | VBUS | USB power supply +5 V |
| | | 2 | D- | USB data - |
| | | 3 | D+ | USB data + |
| | | 4 | - | (No Connect) |
| | | 5 | GND | USB signal ground |
| User I/O | CN1 | Route power and signal wiring suitable for your operation mode. (See "Example of I/O Wiring") | | |

*1) When having single-phase power wired to 1kW drives (DA24A22), connect to L1 and L3.



*2) **Do not connect** when using with single-phase power.

4. Accessory Connector

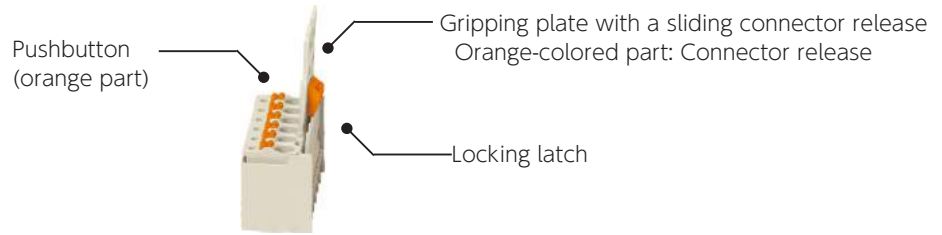
Connector Parts



Stripping cables with recommended tools

| Model Code | | Image |
|------------------|--|--|
| Pushbutton Tools | Use this tool to connect or disconnect a cable to a connector. 210-720 (standard type made in Europe) |  |
| Wire Stripper | Use this tool to make a clean cut without damaging wires. 206-124 (QUICKSTRIP 10) |  |



Trimming the cable insulation:
The leftmost image illustrates a good result. Other two are bad examples.



Specialized Ferrule (recommended)



For stranded wire, a specialized ferrule helps you with wiring more safely and effectively.



| Model Code | | Image |
|-----------------------|--|---|
| Ferrule | Insulated ferrule with sleeve 216-203, red sleeve (for AWG18) 216-206, blue sleeve (for AWG14) |  |
| | Non-insulated ferrule (no sleeve) 216-143 (for AWG18) 216-106 (for AWG14) |  |
| Ferrule crimping tool | 206-204 |  |

2. System Wiring

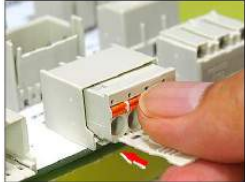
Connecting the connectors

| | | |
|----------------------------------|---|---|
| <p>AC Supply power connector</p> |  | <p>Hold the grip plate and keep pushing in until you hear a clicking sound.</p> |
| <p>Motor power connector</p> |  | <p>Hold the frame of the connector and keep pushing in until you hear a clicking sound.</p> |

Disconnecting the connectors

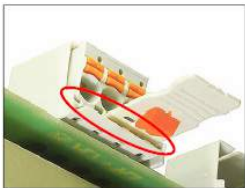
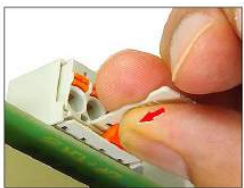
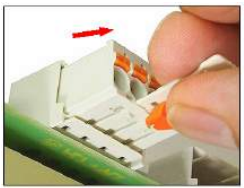
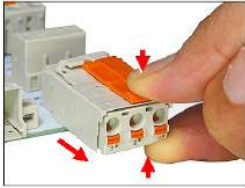
| | | | |
|----------------------------------|---|---|---|
| <p>AC Supply power connector</p> |  |  |  |
| <p>Motor power connector</p> |  | <p>Push in the orange-colored connector release. Pull out the connector.</p> <p>Keep pressing the top lever in the direction of the arrow and pull out the connector.</p> | |

2. System Wiring

Wire connection

With the orange pushbutton pushed in with the tool, insert the wire until it hits the round insertion slot. (the image to the left). Release the pushbutton to finish. (the image in the middle)
 Pull the wire slightly to verify that the wire connection is not loose. (the image to the right)

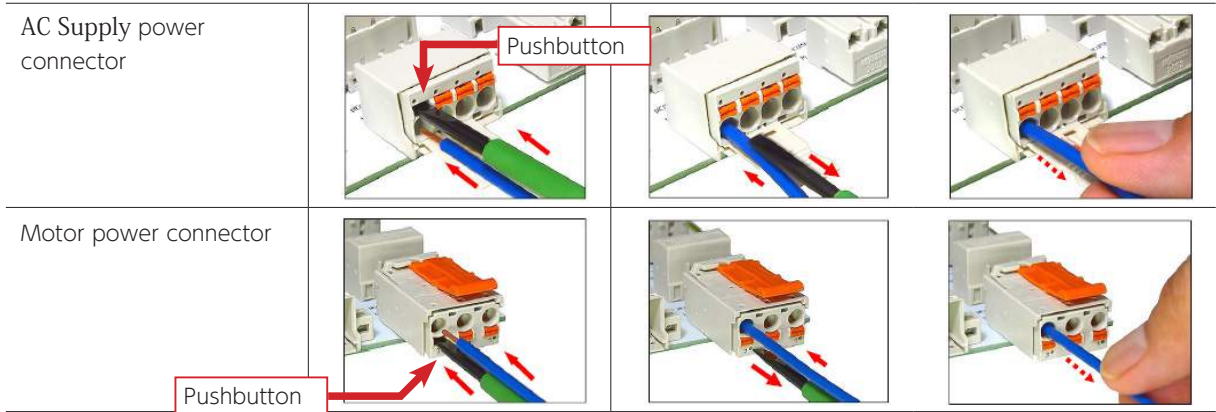

Wire disconnection

While pushing in the pushbutton, pull out the cable.

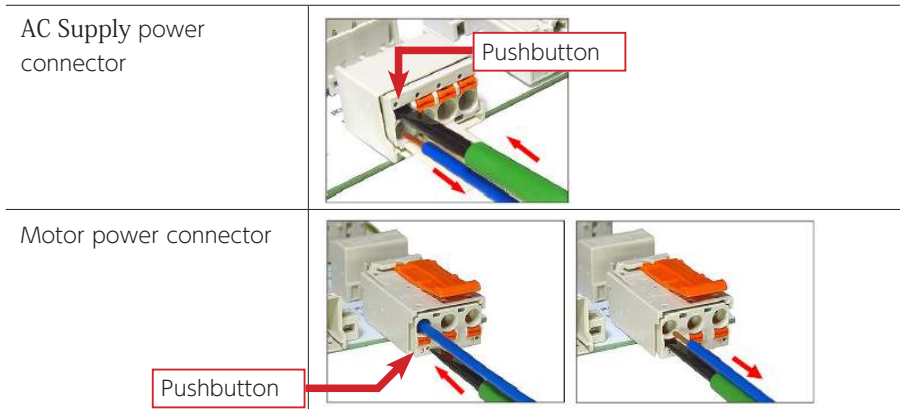

2. System Wiring

5. Cables

Recommended cable wires

Use our recommendations below to select cables based on your actual usage. (Equivalent alternatives are also good)

| Cable Name | AWG | UL | Temperature Rating | Voltage Rating | Note |
|---|---------------------------|-------|--------------------|----------------|---|
| Motor power (≤ 750 W) | 18 | 2517 | 105 °C | 300 V | |
| Motor power (≥ 1 kW) | 14 | 2517 | 105 °C | 300 V | AWG16 wires can be used only for 1 kW motors |
| Main circuit power (≤ 750 W) (Including Earth/ Ground FG cable) | 18 | 1015 | 105 °C | 600 V | |
| Main circuit power (≥ 1 kW) (Including Earth/ Ground FG cable) | 14 | 1015 | 105 °C | 600 V | AWG16 wires can be used only for 1 kW motors. |
| Encoder | Power : 22 Signal : 24 | 20276 | 80 °C | 30 V | Shielded twisted pair cables of length not exceeding 20 m |
| User I/O | 26 | 1007 | 80 °C | 300 V | Shielded twisted pair cables Length not exceeding 2 m is recommended |
| Braking resistor | 18 | 1015 | 105 °C | 600 V | |
| Emergency stop brake | 18 | 1015 | 105 °C | 600 V | |
| Mechanical Brake | 18 | 2517 | 105 °C | 300 V | 1 pair (2 cores) |

3. Timing Diagrams

List of Timing Diagrams

When designing a host controller system, consider the timing of control signal input from the controller to the drive, or alarm signal output from the drive.

| Description | Refer to |
|---|----------|
| Turning the Power On | 25 |
| Servo OFF → ON | 26 |
| Servo ON → OFF (Motor idling) | 27 |
| Servo ON → OFF (Motor rotating) | 28 |
| Alarm Occurs | 29 |
| Alarm Reset (Servo ON) | 30 |
| Alarm Reset (Servo OFF) | 31 |
| Motor Brake Release | 32 |
| Emergency stop Brake Release | 33 |
| Deceleration Stop Status During Coast to stop | 34 |
| Delay time for Quick Stop Complete | 35 |

Timing Diagram Overview

Items related with motion timing

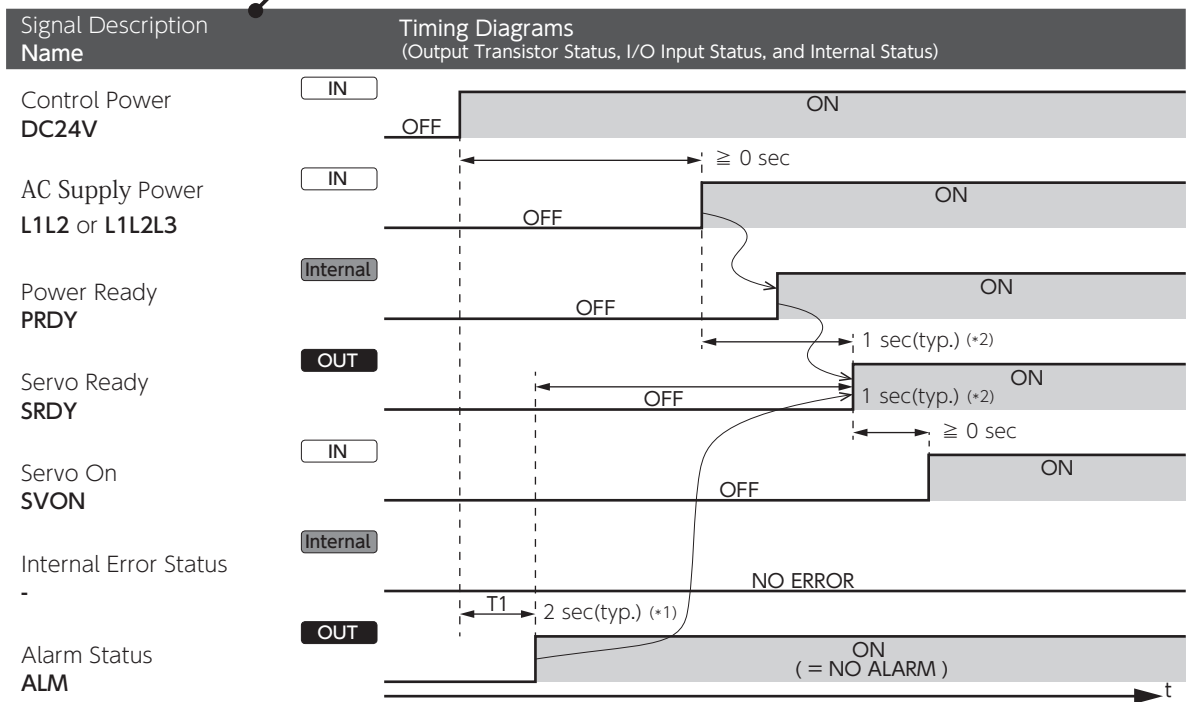

OUT : Output Signal

IN : Input Signal

| Output Transistor | I/O Output Status |
|-------------------|---|
| OFF | Open |
| ON | Close (The contact paired with COM- is closed) |

| Contacts of Input Circuit | I/O Input Status |
|--|------------------|
| Open | OFF |
| Close (Close the contact paired with GND) | ON |

Internal : Internal Status of the Drive

3. Timing Diagrams

Turning the Power On

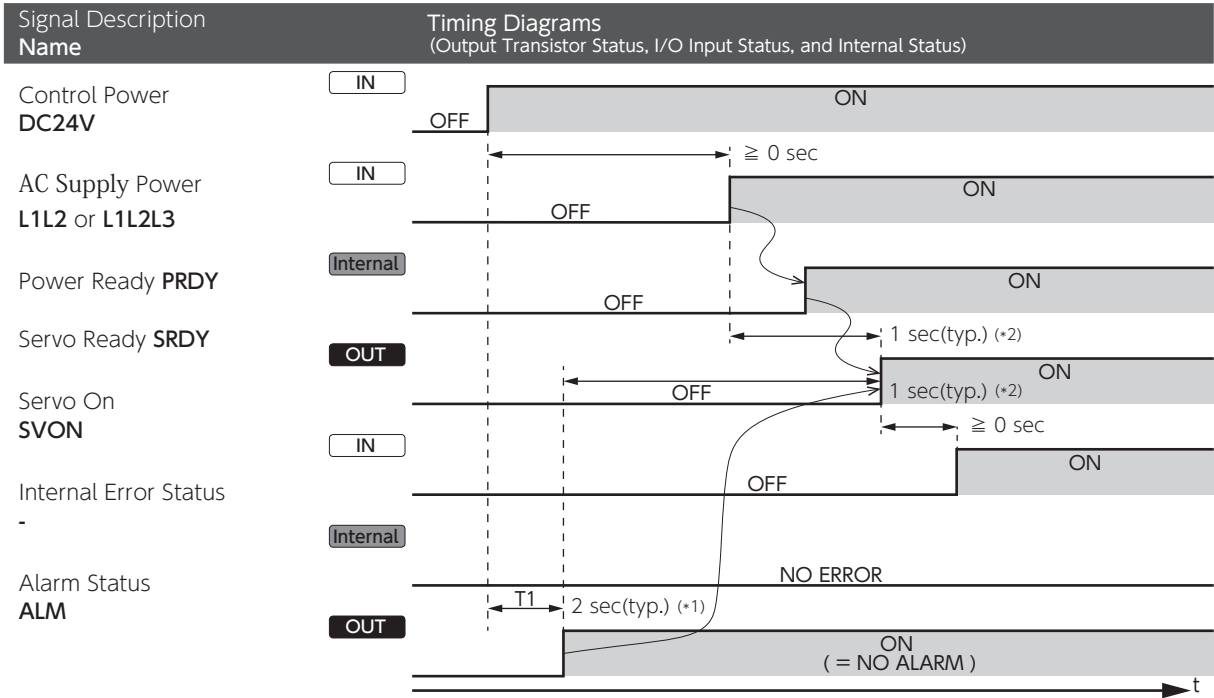

*1) After Clear Parameter execution, T1 needs approximately 5 seconds for parameter initialization.

*2) SRDY turns ON when AC Supply and PRDY turns ON consecutively while Internal Error Status remains No Errors.

3. Timing Diagrams

Servo OFF → ON

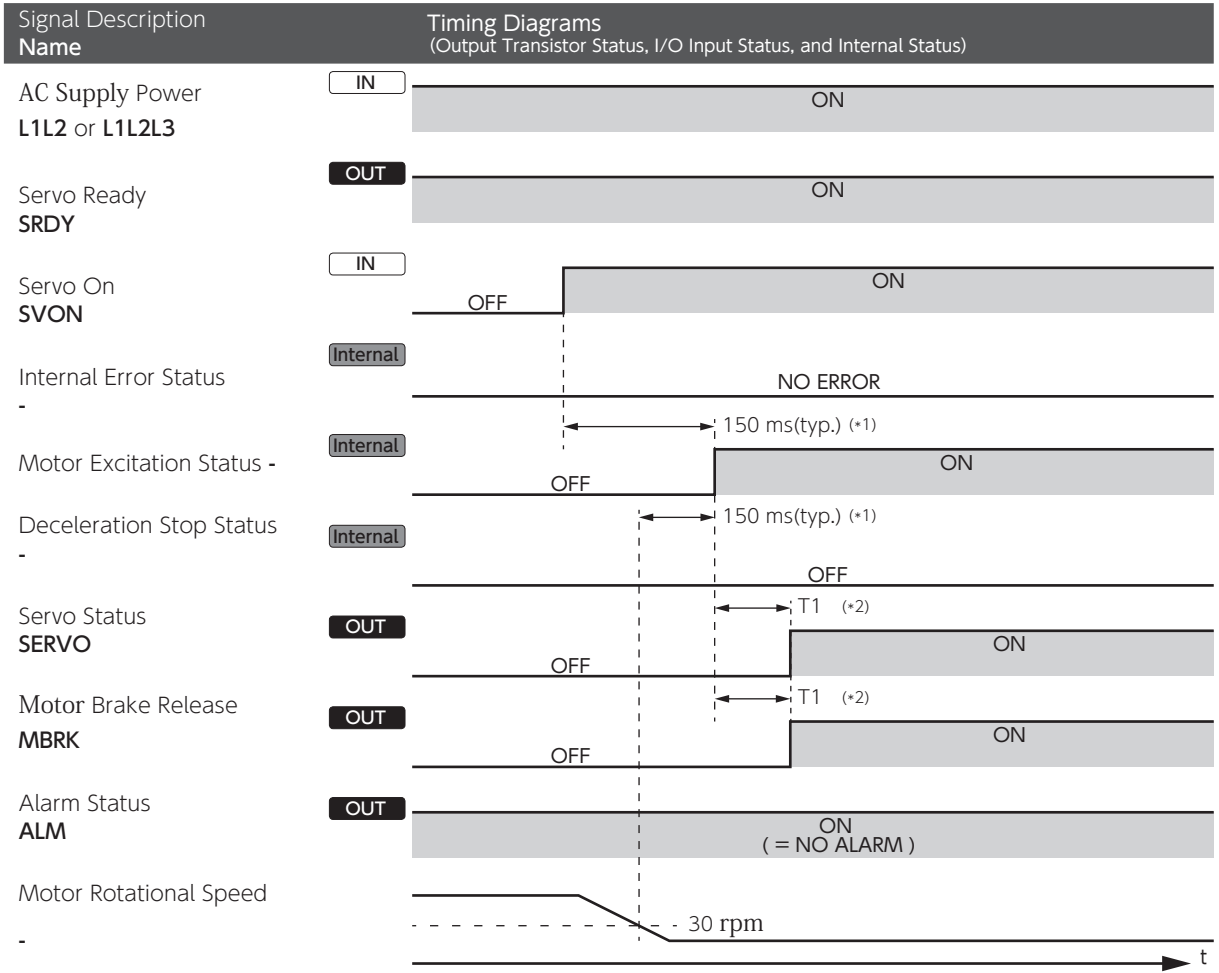

*1) Motor Excitation Status remains OFF until Motor Rotational Speed drops to 30 rpm or below.
 *2) T1 is specified by Brake-Release Delay Time (No.238.0).

3. Timing Diagrams

Servo ON → OFF (Motor idling)

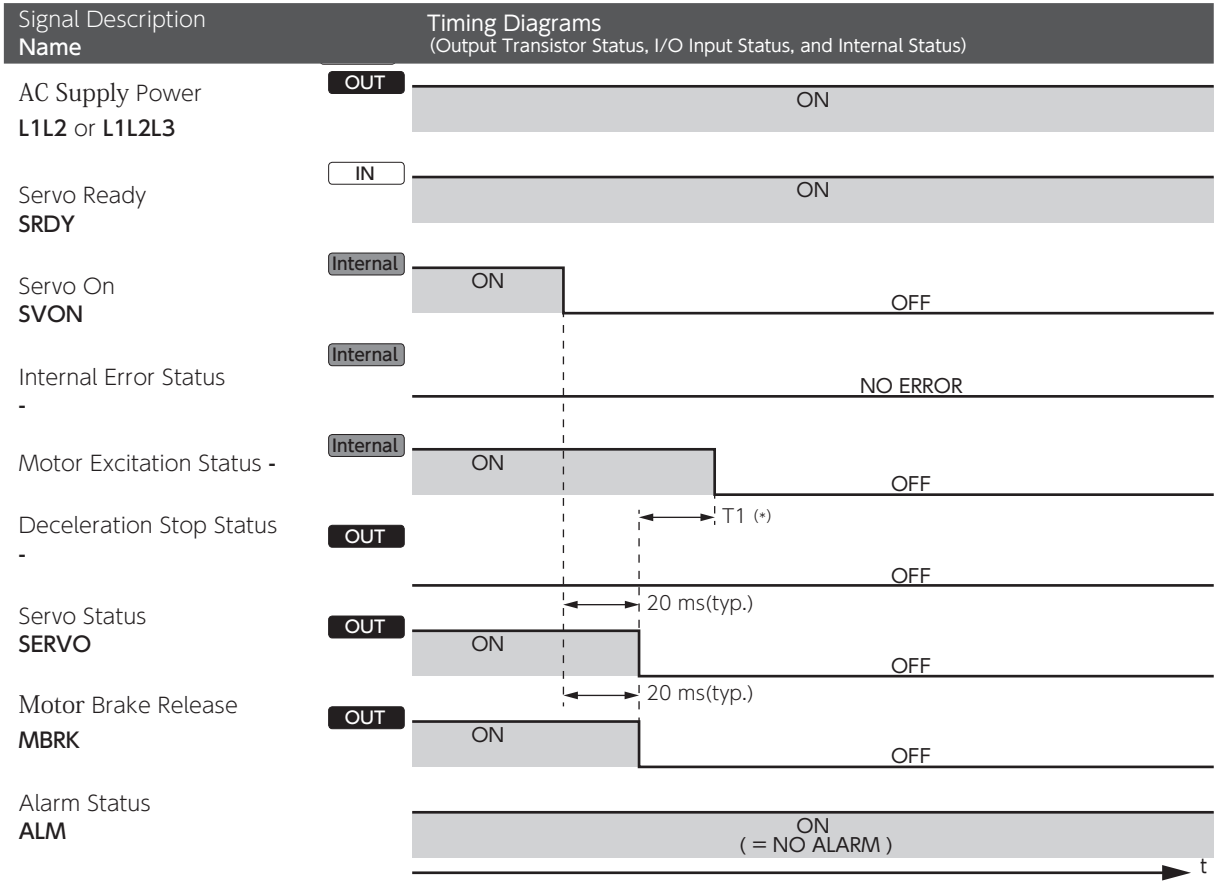

*) T1 is specified by Servo OFF Delay time (No.237.0).

3. Timing Diagrams

Servo ON → OFF (Motor rotating)

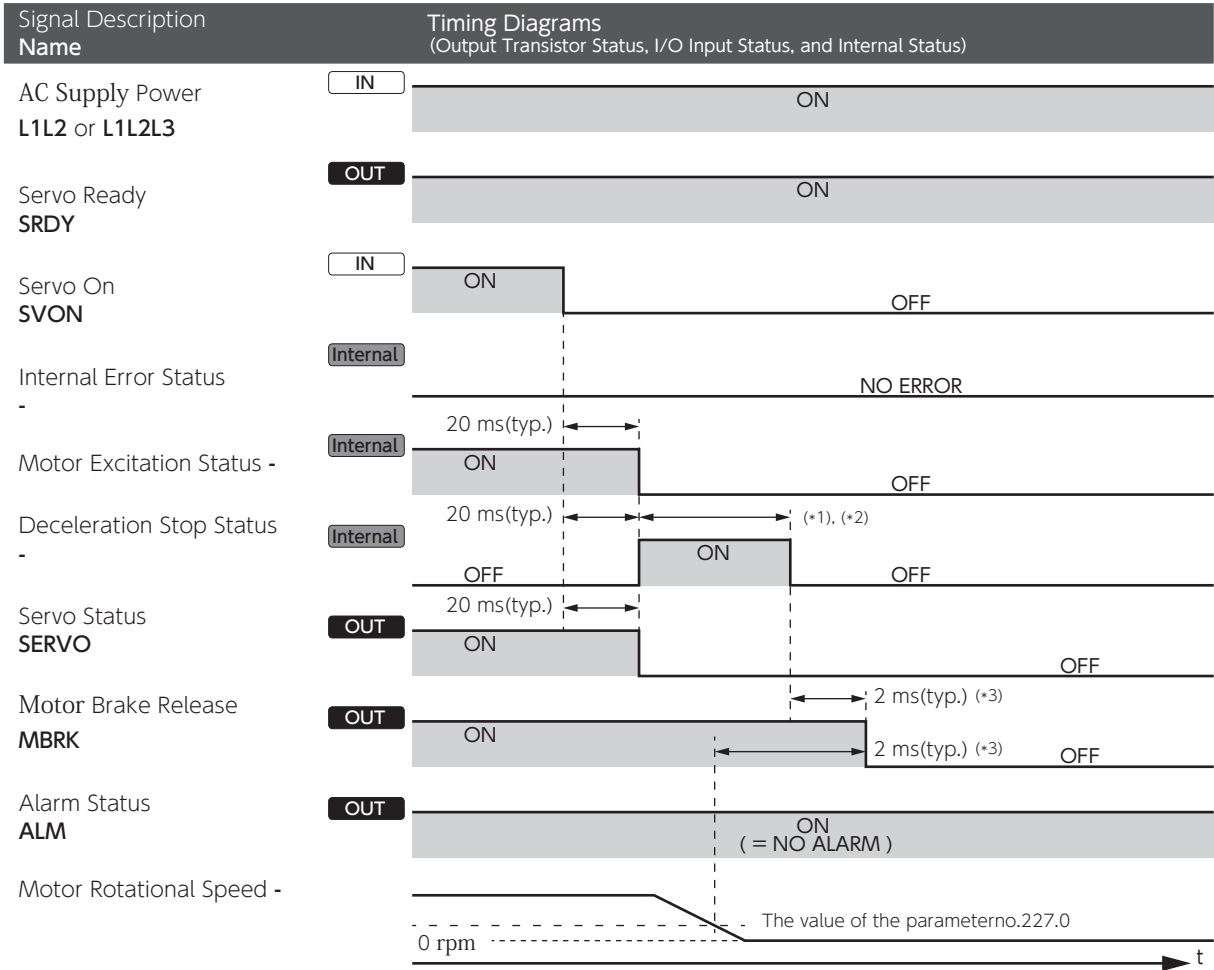

*1) The motor decelerates according to the method specified by Deceleration Stop Method (No.224.0)
 *2) Quick stop or Short brake ends when deceleration stop conditions set by parameters (No.224.1, No.226.0, and No.227.0) are met.
 *3) Deceleration Stop Method (No.224.0) = 2 (quick stop) or 1 (short brake)
 MBRK turns OFF when one of the following conditions is met:
 a) **Deceleration Stop Status** turns OFF
 b) The rotational speed drops to the value specified by [Deceleration stop Rotational speed to cancel (No.227.0)] or below.
Deceleration Stop Method (No.224.0) = 0 (coast to stop)
 MBRK turns OFF when **Motor Excitation Status** becomes OFF.

Alarm Occurs

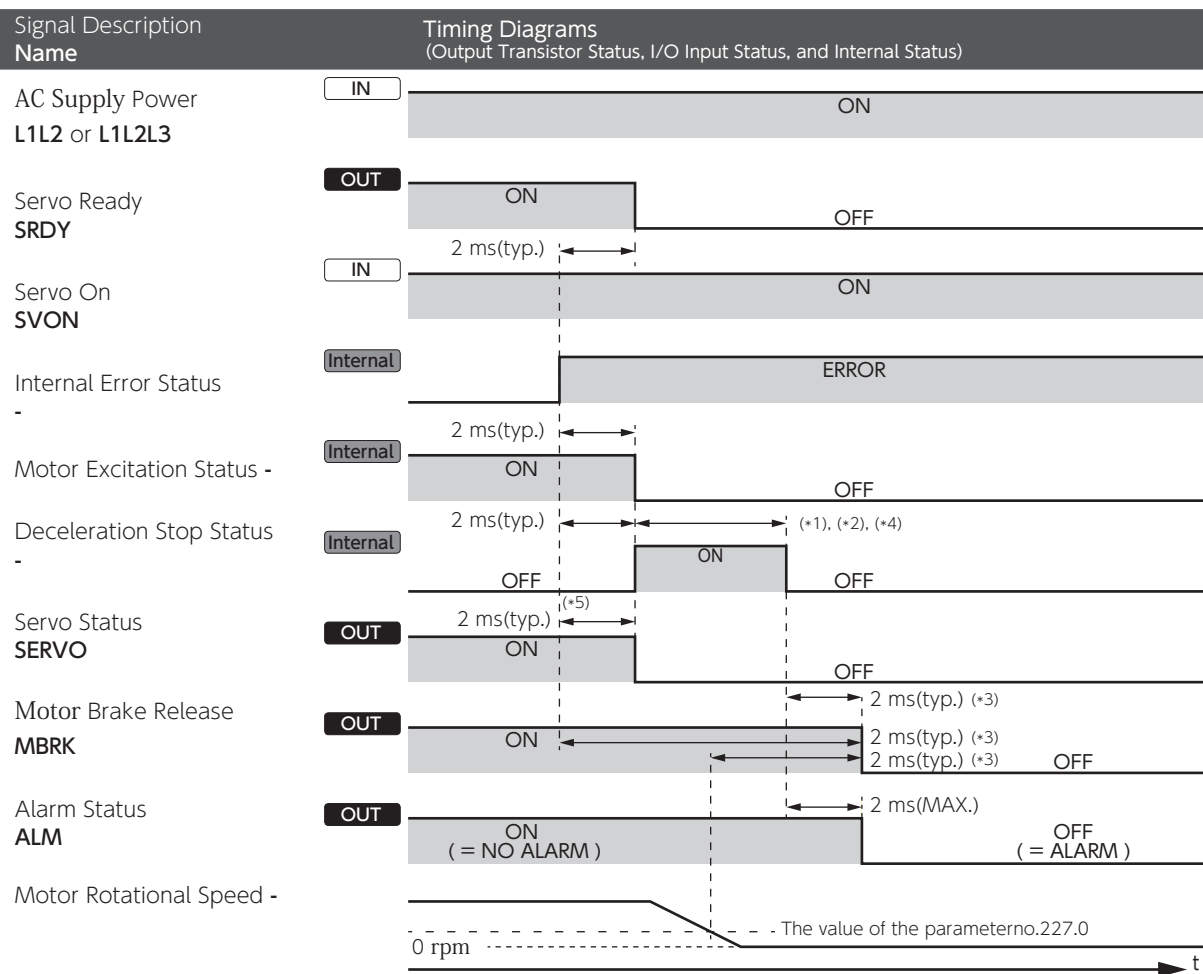

*1) The motor will stop per Deceleration Stop Method (No.224.0) as follows.
2 (quick stop) or 1 (short brake) : the motor decelerates and stops by short brake.
0 (Coast to stop) : no brake.

*2) **Deceleration Stop Status** ends when deceleration stop conditions set by the parameters (No.224.1, No.226.0, and No.227.0) are met.

*3) Timing of **MBRK** turning OFF

If Deceleration Stop Method (No.224.0) = 2 (quick stop) or 1 (short brake).

MBRK turns OFF when one of the following conditions is met.

1) **Deceleration Stop Status** turns OFF

2) **Motor Rotational Speed** drops to the value specified by the parameter No.227.0 or below.

If Deceleration Stop Method (No.224.0) = 0 (no brake).

MBRK turns OFF when **Motor Excitation Status** turns OFF.

If any of the following alarms occurs.

MBRK turns OFF when the internal error status becomes **ERROR**.

a) Encoder related errors

b) Control Power voltage drop error

c) Errors related to Inverter output part

d) Overvoltage error

If any alarm except above four occurs, the motion pattern will be exactly as this timing diagram suggests.

*4) Deceleration Stop behaves as follows depending on the error type:

a) Encoder related errors: Deceleration Stop per [Deceleration stop operating time (Parameter No. 226.0)]

b) Control Power voltage drop error: Deceleration Stop per [Deceleration stop (upon control power failure) Operating time (No.228.0)]

c) Errors related to Inverter output part: Coast to stop

*5) In case of the following alarms, **Servo Status** will remain ON until **Deceleration Stop Status** turns OFF.

a) Encoder related errors

b) Control power voltage drop error

3. Timing Diagrams

Alarm Reset (Servo ON)

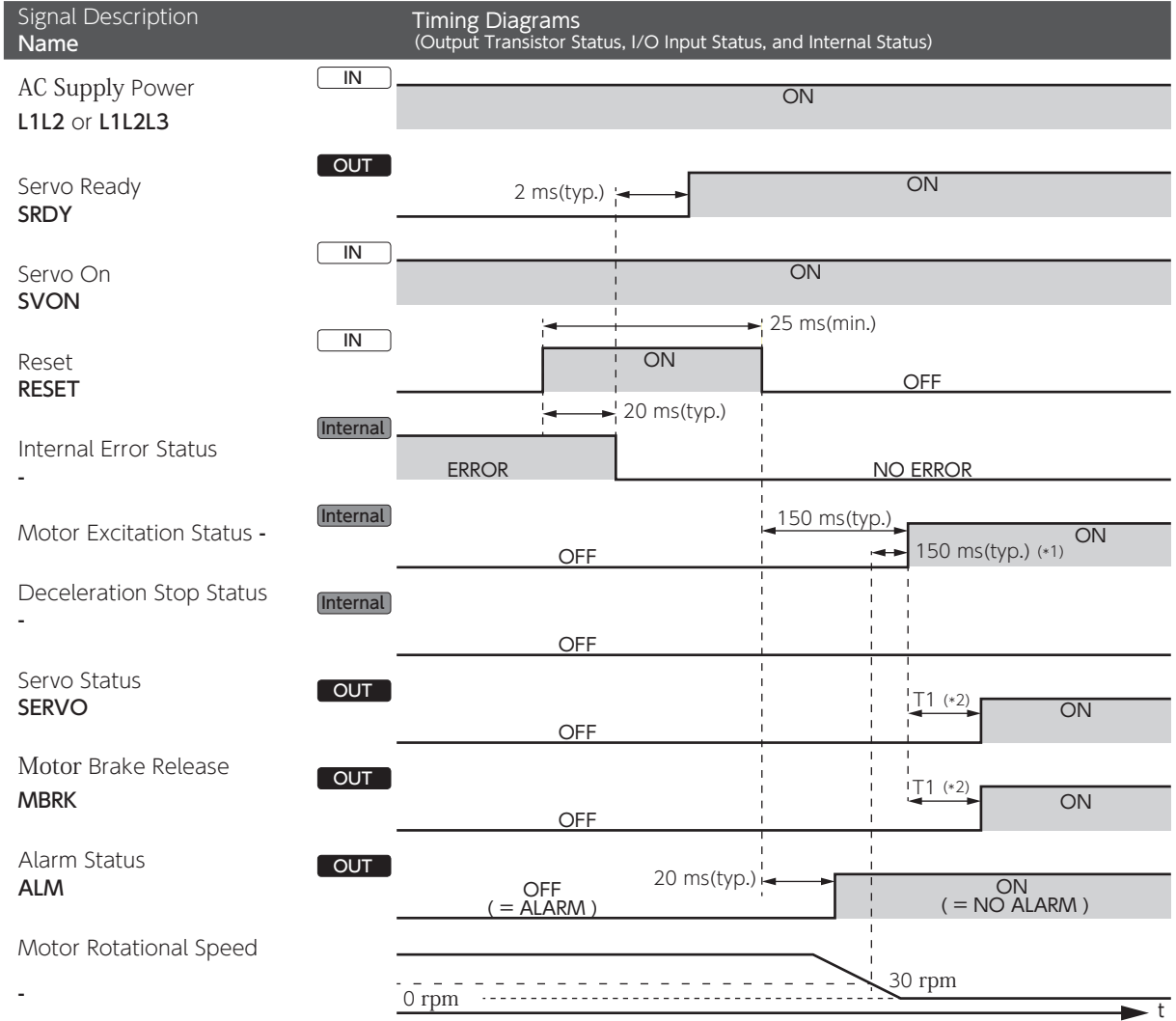

*1) Motor Excitation Status remains OFF until motor rotational speed drops to 30 rpm or below.
 *2) T1 is specified by Brake release Delay time (No.238.0).

3. Timing Diagrams

Alarm Reset (Servo OFF)

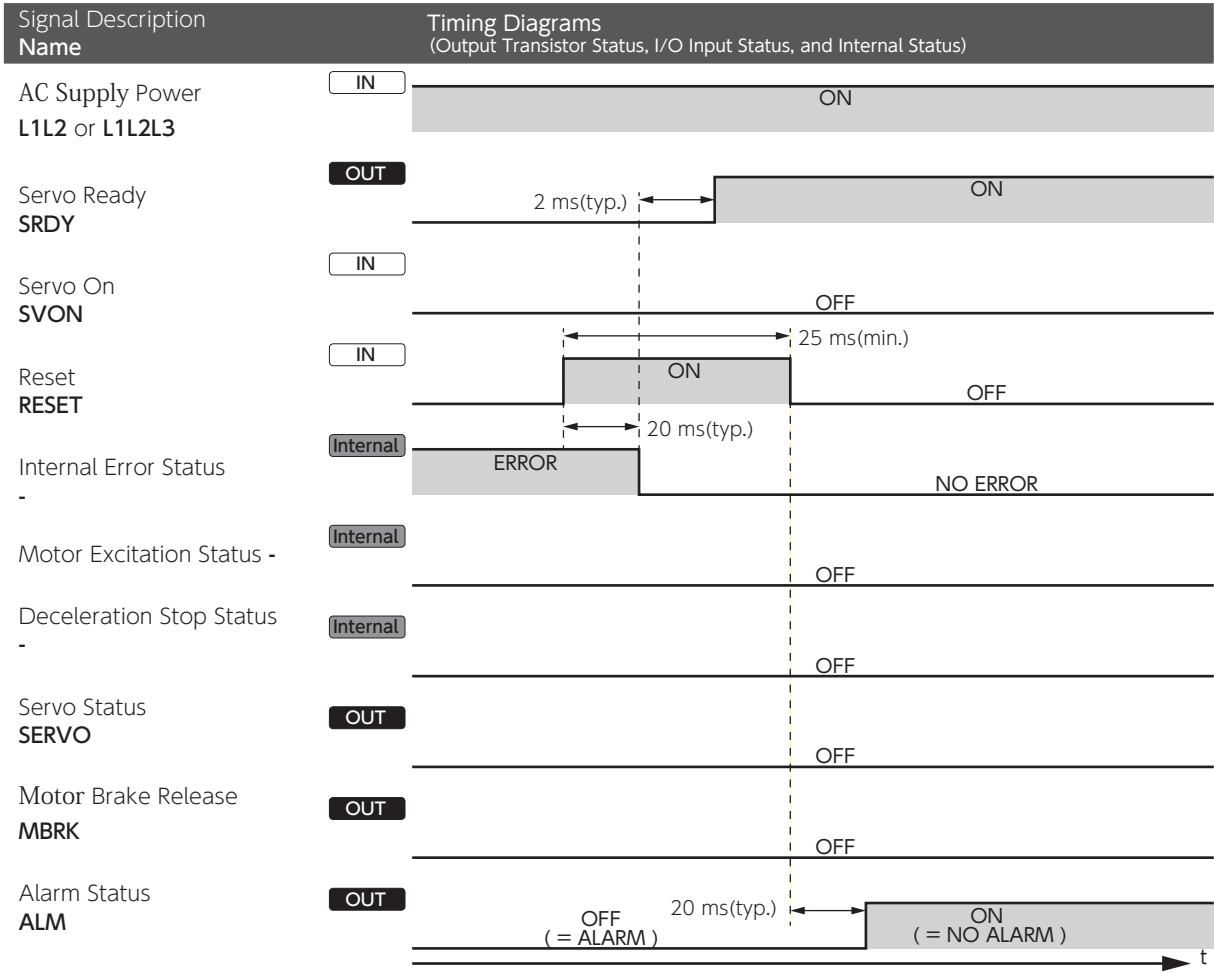

3. Timing Diagrams

Motor Brake Release

Deceleration Stop: Timing for Engaging Brake (No.232.3) = 0

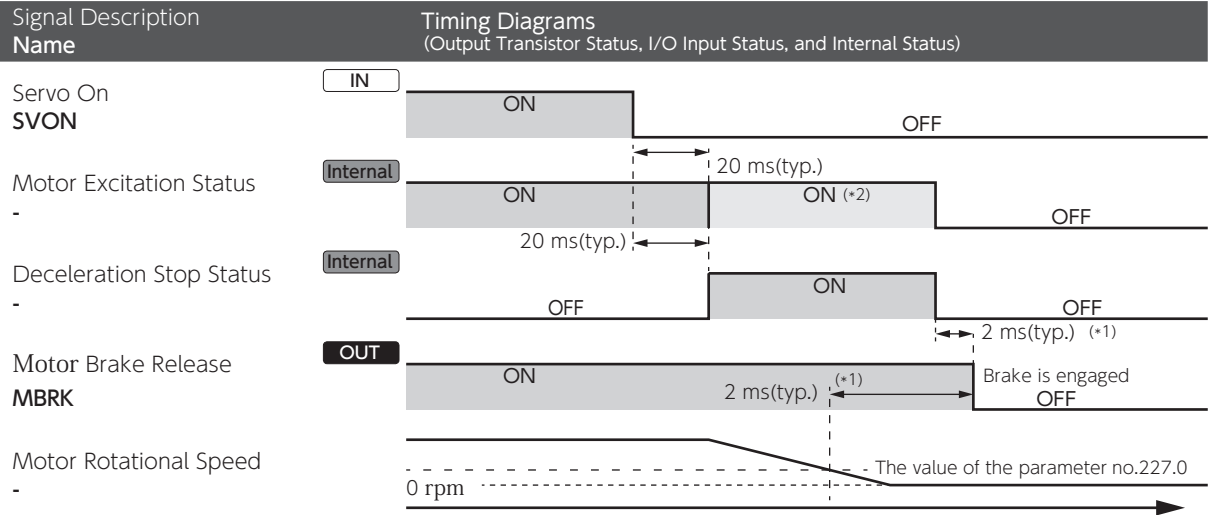

- *1) MBRK turns OFF is when one of the following becomes true, a) Deceleration Stop completes, or b) Motor rotational speed drops to the value of [Deceleration stop - Rotational speed to cancel (No.227.0)] or below.
- *2) If the deceleration stop method is quick stop, the motor will remain excited during deceleration stop.

Deceleration Stop: Timing for Engaging Brake (No.232.3) = 1

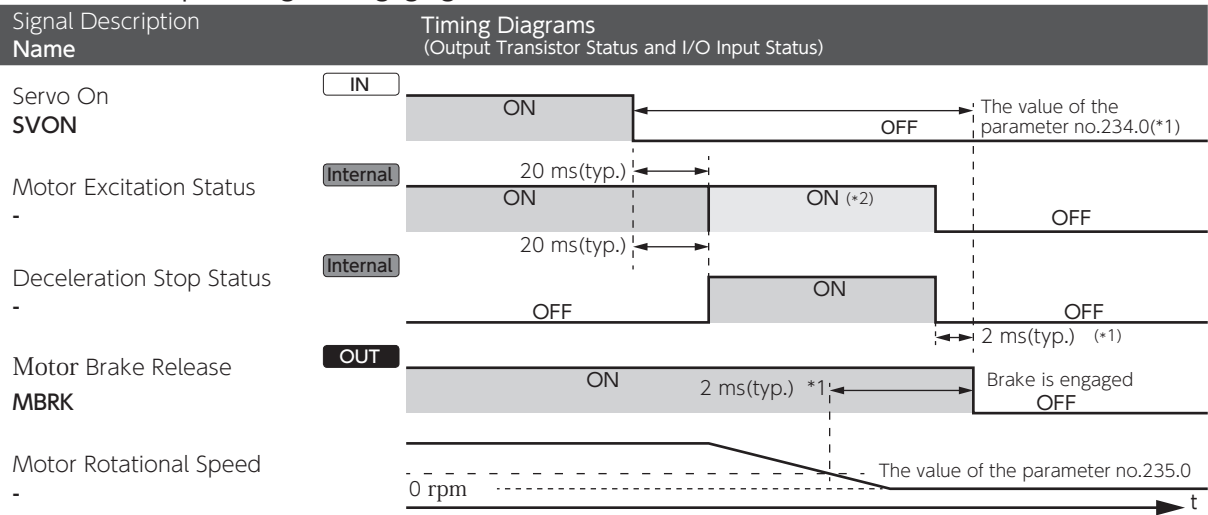

- *1) MBRK turns OFF is when one of the following becomes true, a) Deceleration Stop completes, or b) Motor rotational speed, after the time specified by Parameter No.234.0 elapses, drops to the value specified by Parameter No.235.0 or below.
- *2) If the deceleration stop method is quick stop, the motor will remain excited during deceleration stop.

3. Timing Diagrams

Emergency stop Brake Release

Upon Servo ON, if Deceleration stop (when Servo is OFF) : Method (No.224.0) = 3 (emergency stop brake)

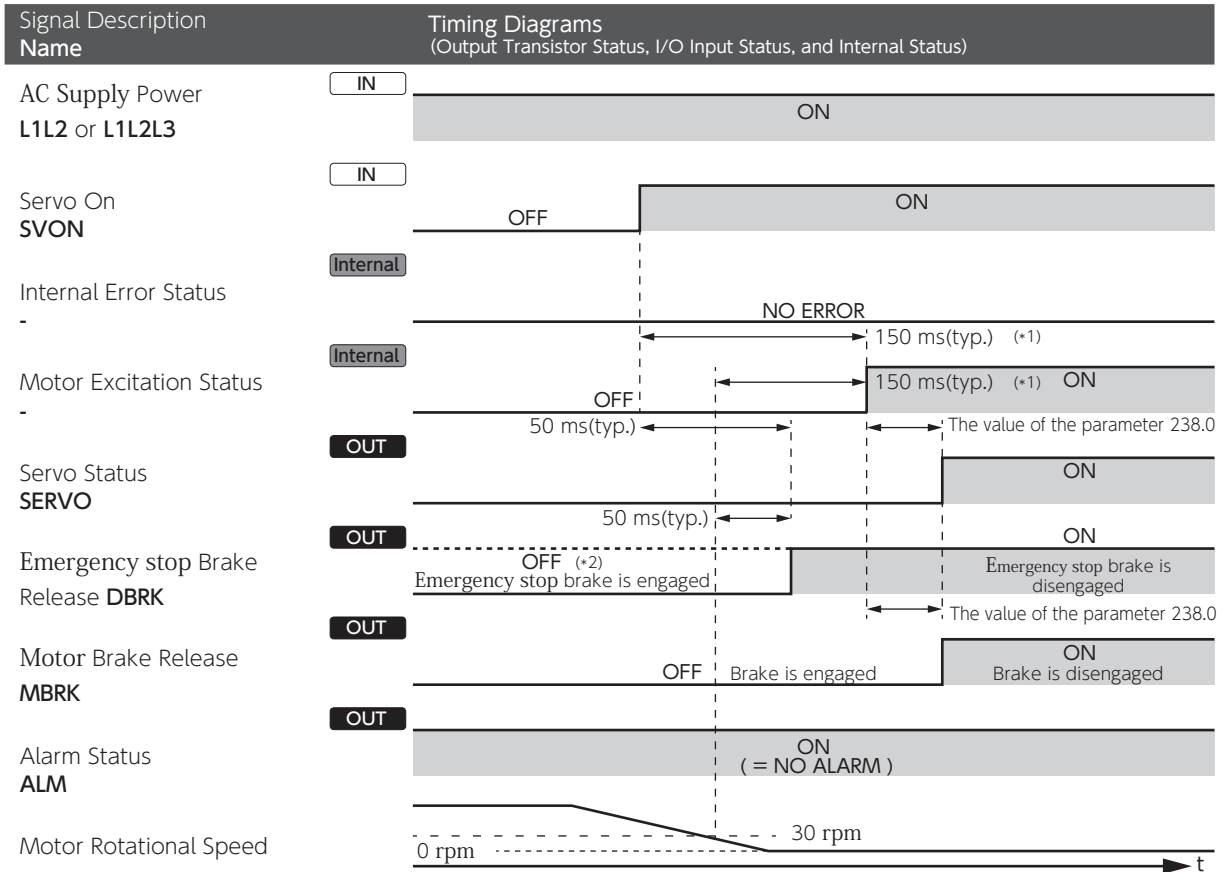

*1) SERVO does not turn ON until Motor Rotational Speed drops below 30 rpm.
 *2) When DBRK output (No.224.3) = 1 (emergency stop brake) after a stop per Deceleration Stop (when Servo is OFF)

Upon Alarm Clear, if Deceleration stop (when Servo is OFF) Method (No.224.0) = 3 (emergency stop brake)

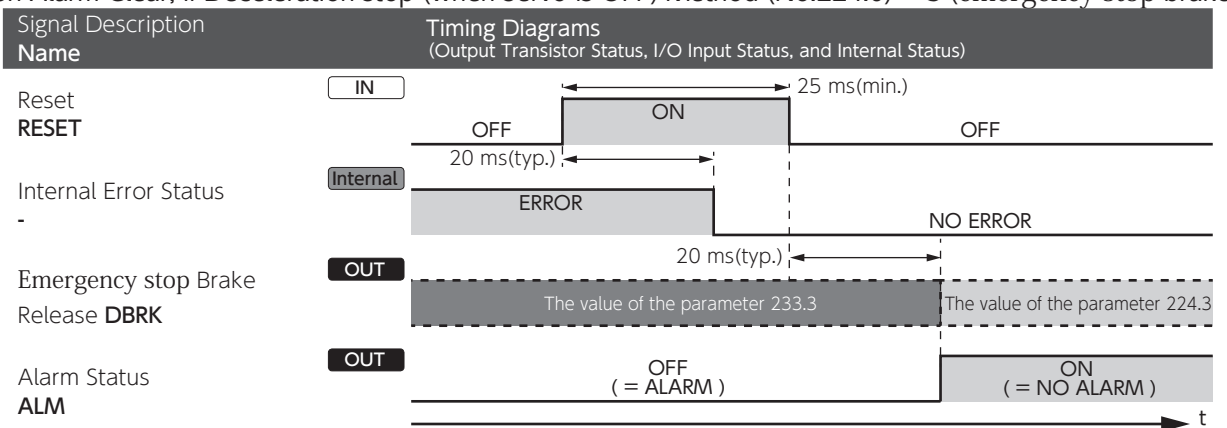

3. Timing Diagrams

Deceleration Stop Status where [Deceleration Stop Method (at Servo OFF) (No.224.0)] and [Deceleration Stop Method (at Alarm ON)] are set to coast to stop

Deceleration Stop Status During Coast to Stop

Deceleration stop: Deceleration stop status during coast to stop (No.232.1) = 0 (OFF)

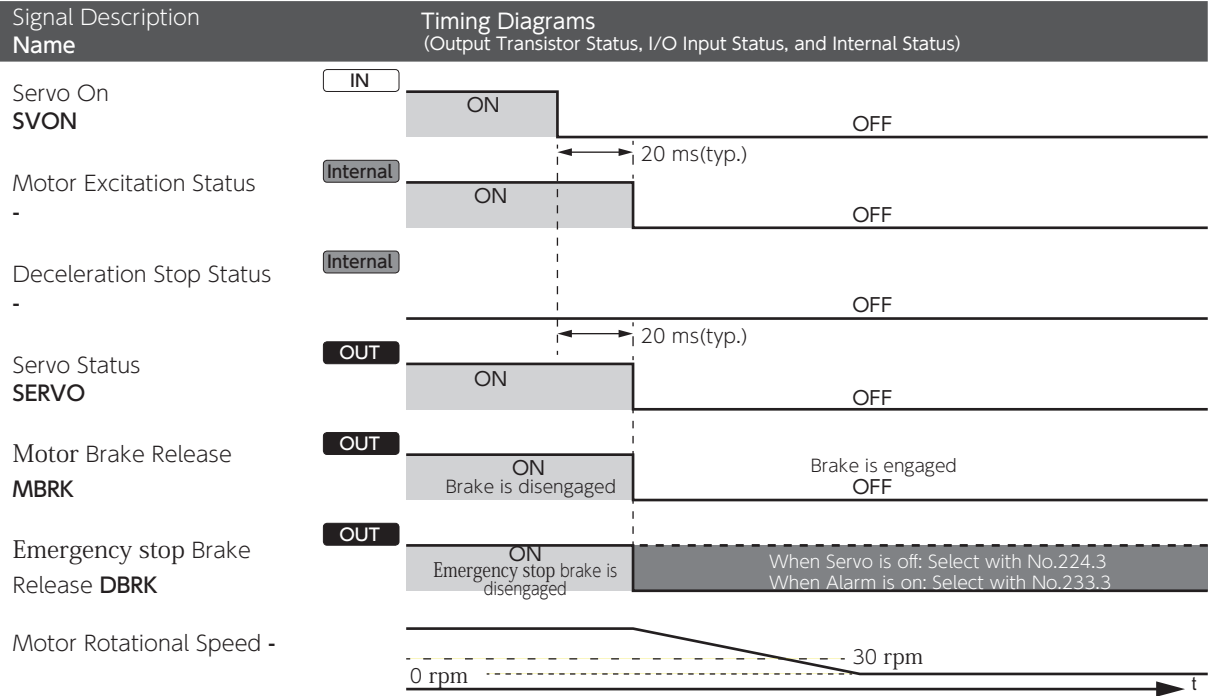

Deceleration stop: Deceleration stop status during coast to stop (No.232.1) = 1 (ON)

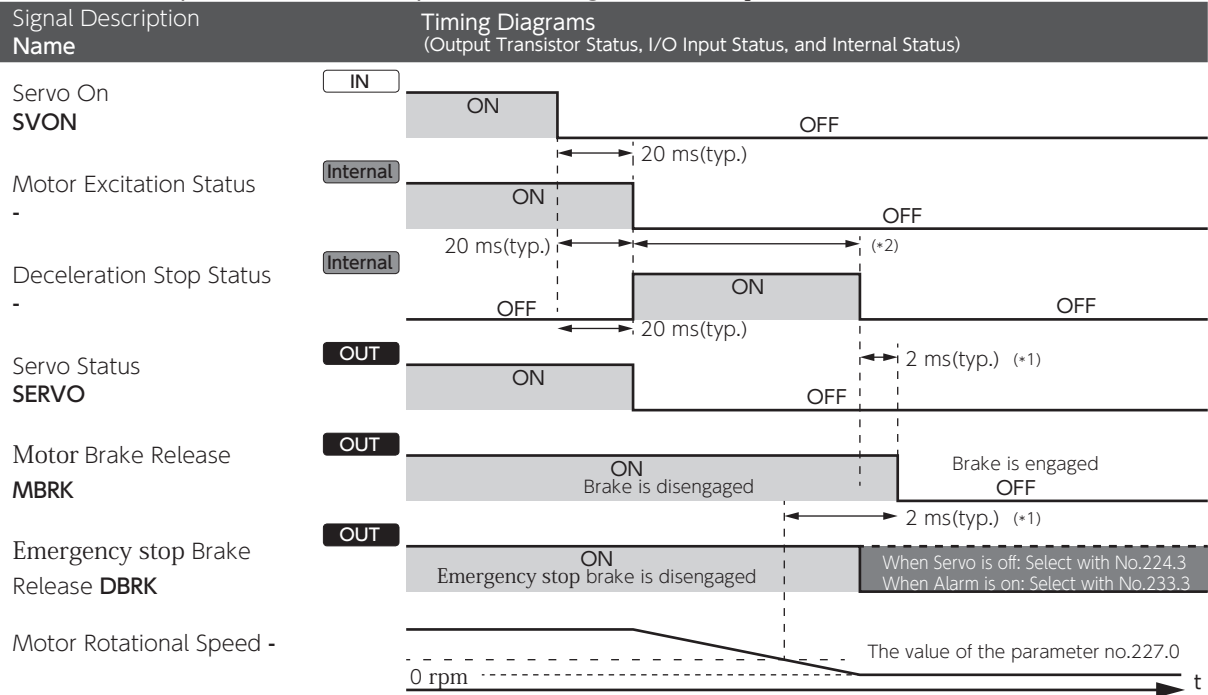

*1) MBRK turns OFF when one of the following conditions is met:
 a) Deceleration Stop Status turns OFF.
 b) Motor Rotational Speed drops to the value of [Deceleration stop - Rotational speed to cancel (No.227.0)] or below.
 *2) Deceleration Stop Status turns OFF when deceleration stop conditions (No.224.1, 226.0, or 227.0) are met.

3. Timing Diagrams

When Servo becomes OFF while motor is in motion and then the motor decelerates to stop by the quick stop method.

Delay time for Quick Stop Complete

Deceleration stop: Method (at Servo OFF) (No.224) = 2 (quick stop)

Signal Description
Name

Timing Diagrams
(Output Transistor Status, I/O Input Status, and Internal Status)

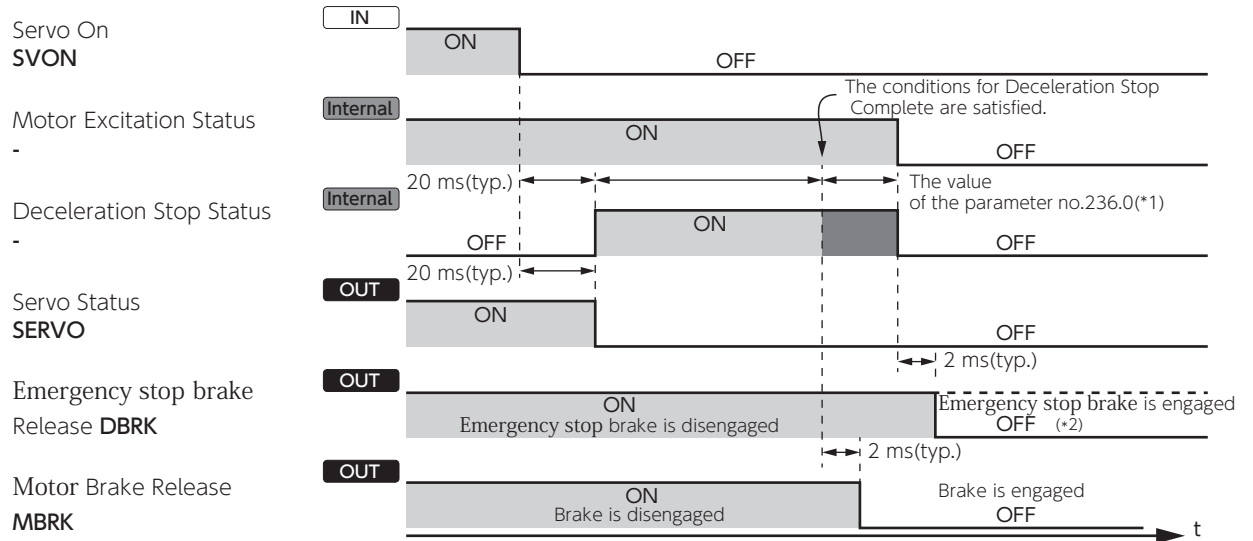













*1) **Deceleration Stop Status** turns OFF after the deceleration stop conditions set by the parameters (No.224.1, 226.0, and 227.0) are met and the time amount set to [Quick Brake Delay Time (No.236.0)] elapses.

*2) when **DBRK** output (No.224.3) = 1 (emergency stop brake) after Deceleration Stop (at Servo OFF) ends.

| | |
|--|----|
| 1. Introduction | 2 |
| 2. Position Control Mode | 4 |
| 1. Pulse Train Command | 4 |
| Differential, Standard I/O Setting | 4 |
| Differential, I/O Setting Option 1 | 6 |
| Differential, I/O Setting Option 2 | 8 |
| 24V open collector, Standard I/O configuration | 10 |
| 5V open collector, Standard I/O configuration | 12 |
| 2. Internal Position Command | 14 |
| Standard I/O Configuration | 14 |
| Optional I/O Configuration | 16 |
| 3. Velocity Control Mode | 18 |
| 1. Analog Velocity Command | 18 |
| 2. Internal Velocity Command | 20 |
| 4. Torque Control Mode | 22 |
| 1. Analog Torque Command | 22 |
| 5. Descriptions of CN1 Connector Signals | 24 |
| 1. Descriptions of CN1 Connector Signals | 24 |
| General-Purpose Input | 25 |
| General-Purpose Output | 33 |
| Command Input | 40 |
| Encoder Output | 43 |
| RS-485 Communication | 44 |
| 2. Interface Circuit of CN1 Connector | 45 |
| Interface Circuit | 45 |

1. Introduction

Digitax SF features seven operation modes for motor, which are combinations of Control Mode and Command Mode options. Follow the appropriate CN1 connector wiring according to the mode that you are using.

| Control Mode | Command Mode | Command Input Signal Format | |
|------------------|---|--|--|
| Position Control |  Pulse Train Command (*) |  Differential | |
| | |  24V open collector | |
| | |  5V open collector | |
| Velocity Control |  Internal Command (*) |  I/O Operation | |
| | |  Analog Command |  Analog Voltage |
| | |  Internal Command |  I/O Operation |
| Torque Control |  Analog Command |  Analog Voltage | |

*) Select one of I/O setup types: "Standard I/O configuration" or "Optional I/O configuration"
 When using one of the optional I/O configurations, use Digitax SF Connect to make the setting change.

Pulse Train Command

- Select the pulse signal input from the following three types:
- pulse and direction
 - quadrature pulse (A-phase+B-phase)
 - positive or negative pulse (CCW and CW)

Analog Command

The range of input voltages is -10V to +10V.

Internal Command

The motor is operated based on the motion conditions that are preset in the drive. Operations are changed by combinations of command selection pins assigned to the I/O.

Changing the I/O configuration by Digitax SF Connect

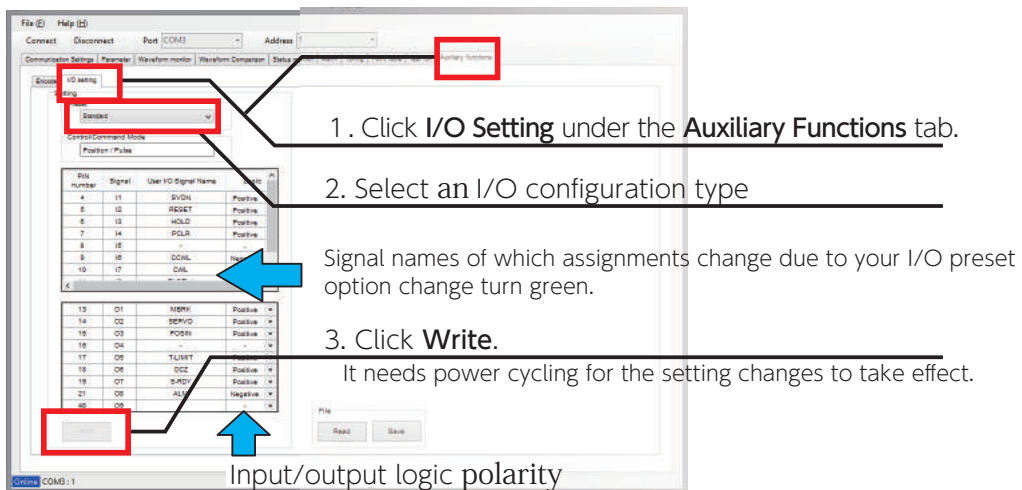

1. Click **I/O Setting** under the **Auxiliary Functions** tab.

2. Select an I/O configuration type

Signal names of which assignments change due to your I/O preset option change turn green.

3. Click **Write**.

It needs power cycling for the setting changes to take effect.

Input/output logic polarity

| Pin Number | Signal | User I/O Signal Name | Polarity |
|------------|--------|----------------------|----------|
| 4 | I1 | SVON | Positive |
| 5 | I3 | RESET | Positive |
| 6 | I3 | WOLD | Positive |
| 7 | I4 | PCLR | Positive |
| 8 | I5 | ... | ... |
| 9 | I6 | DCAL | ... |
| 10 | I7 | DIAL | ... |
| 11 | I8 | ... | ... |
| 12 | O1 | INPR | Positive |
| 14 | O2 | SEVP | Positive |
| 15 | O3 | POSR | Positive |
| 16 | O4 | ... | ... |
| 17 | O5 | TUNST | Positive |
| 18 | O6 | DCZ | Positive |
| 19 | O7 | SAPO | Positive |
| 21 | O8 | ALP | Negative |
| 22 | O9 | ... | ... |

1. Introduction

Pinout Diagram

The pinout depends on the control mode / motion mode that you are using. Pins are grouped to five categories.

| Group | Description |
|------------------------|---|
| General-Purpose Input | The pinout depends on the control mode / motion mode that you are using. These are input terminals, such as control power, I/O power, and Servo ON. You can change the input logic. * |
| General-Purpose Output | The pinout depends on the control mode / motion mode that you are using. This is an output terminal such as Servo Status that connects to the host controller. You can change the output logic. * |
| Command Input | The pinout depends on the control mode / motion mode that you are using. This is an input terminal that receives a command signal from the host controller such as Pulse Train Command or Analog Command. |
| Encoder Output | A terminal to output encoder pulse to the host controller. |

RS-485 Communication RS-485 interface to communicate with the host controller.

*  page 24 Descriptions of CN1 Connector signals

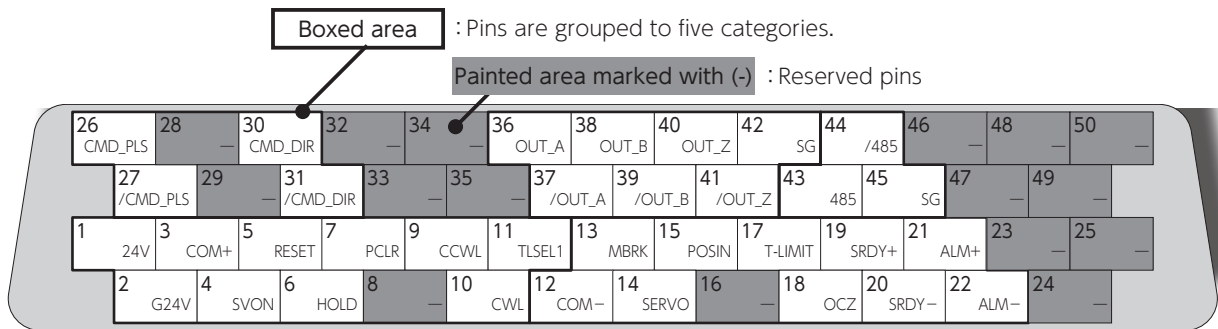

The pinout diagram below illustrates the pin layout when viewing the plug-in connector looking at the pins to which the control cables are soldered. Do not connect anything to reserved pins.



Example: Position control mode- Pulse Train Command, Differential, Standard I/O Configuration

CN1 Connector Wiring Example

Example of CN1 Connector Wiring The pinout depends on the control mode-motion mode that you are using. For actual wiring, check the pin numbers etched on the connector body as well. For further details, refer to Descriptions of CN1 Connector Signals and Interface Circuit of CN1 Connector.

 page 24 Descriptions of CN1 Connector Signals
 page 45 Interface Circuit of CN1 Connector

4. Connections

2. Position Control Mode

1. Pulse Train Command

Differential, Standard I/O Setting



Pinout Diagram

| Command Input | | Encoder Output | | RS-485 Communication | |
|---------------|--|----------------|----------------------------|----------------------|----------------------------|
| Pin No. | Signal Description | Pin No. | Signal Description | Pin No. | Signal Description |
| 26 | CMD_PLS Pulse, QEP A-phase or CCW | 36 | OUT_A A-phase | 44 | /485 /Data |
| 27 | /CMD_PLS /Pulse, QEP /A-phase or /CCW | 37 | /OUT_A /A-phase | 43 | 485 Data |
| 30 | CMD_DIR Direction, QEP B-phase or CW | 38 | OUT_B B-phase | 45 | SG Signal ground |
| 31 | /CMD_DIR /Direction, QEP /B-phase or /CW | 39 | /OUT_B /B-phase | | |
| | QEP: Quadrature encoder pulse | 40 | OUT_Z Z-phase | | |
| | | 41 | /OUT_Z /Z-phase | | |
| | | 42 | SG Signal ground | | |

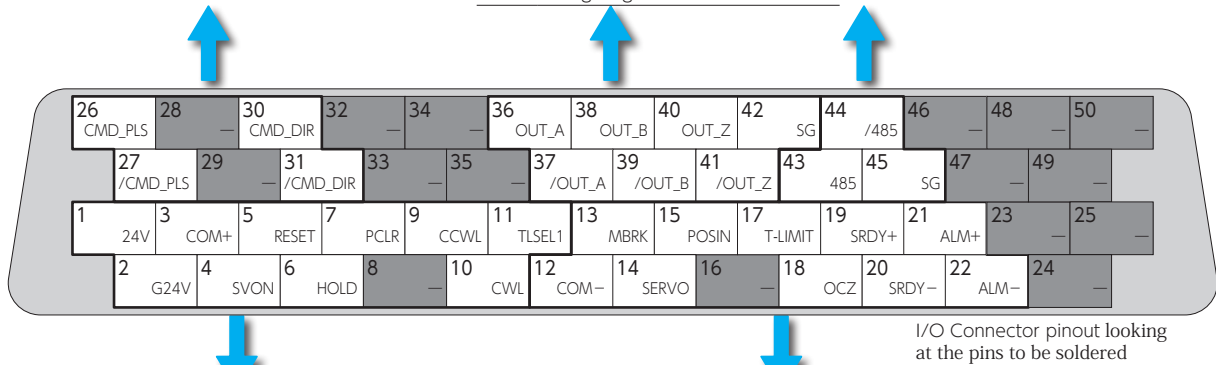

| General-Purpose Input | |
|-----------------------|---|
| Pin No. | Signal Description |
| 1 | 24V Control power 24V |
| 2 | G24V Control power GND |
| 3 | COM+ I/O Power 24V |
| 4 | SVON Servo ON |
| 5 | RESET Alarm reset |
| 6 | HOLD Command input prohibited |
| 7 | PCLR Error counter clear |
| 9 | CCWL CCW drive limit switch input |
| 10 | CWL CW drive limit switch input |
| 11 | TLSEL1 Torque Limit |

| General-Purpose Output | |
|------------------------|--|
| Pin No. | Signal Description |
| 12 | COM - I/O power GND |
| 13 | MBRK Motor Brake release |
| 14 | SERVO Servo status |
| 15 | POSIN Positioning complete |
| 17 | T-LIMIT Torque limiting |
| 18 | OCZ Encoder Z-phase (open collector) |
| 19 | SRDY+ Servo ready+ |
| 20 | SRDY - Servo ready - |
| 21 | ALM+ Alarm status+ |
| 22 | ALM - Alarm status - |

2. Position Control Mode

CN1 Connector Wiring Example

Pulse Train Command, Differential, Standard I/O Configuration

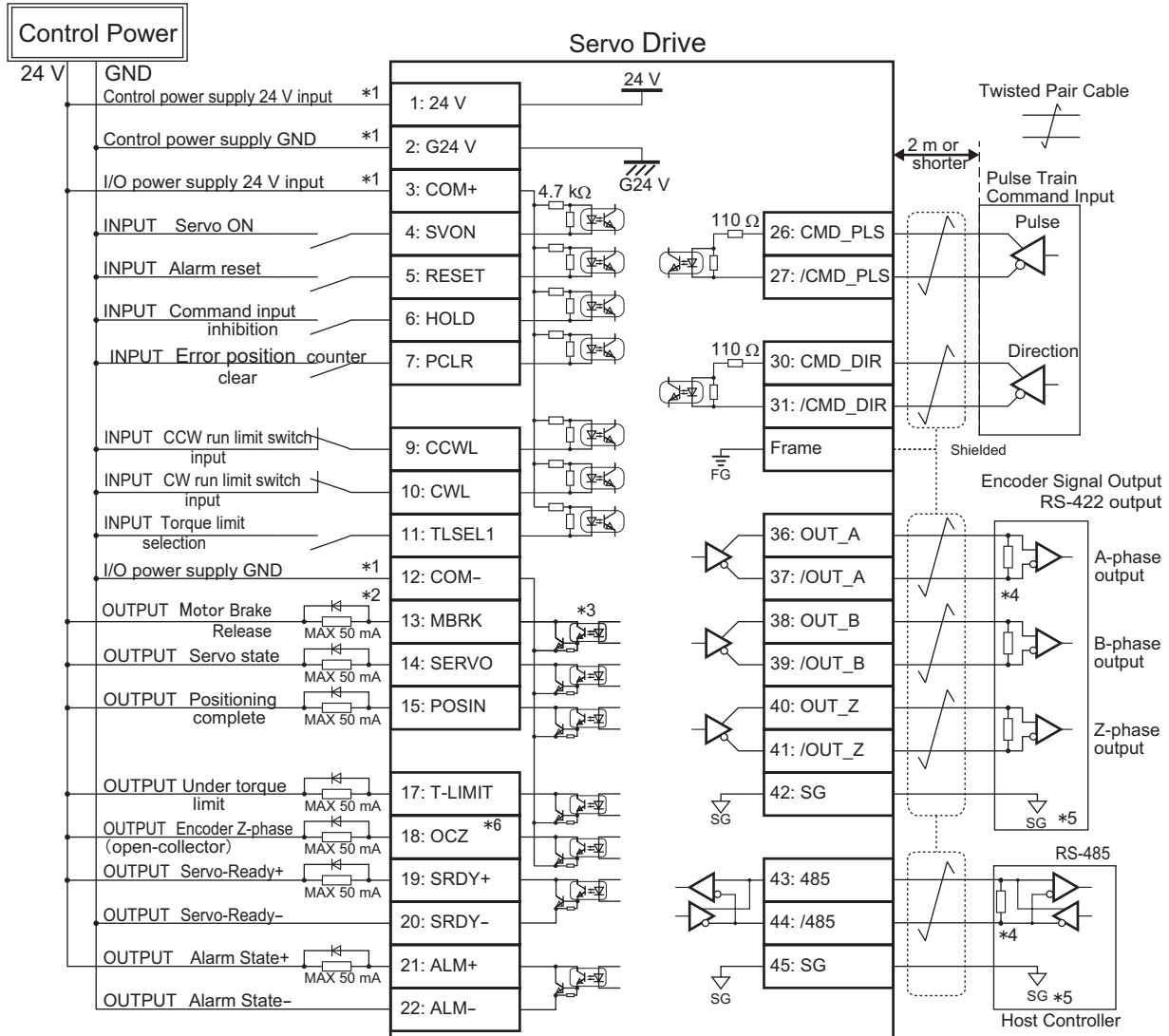

*1) Control power (24V, G24V) and power for I/O (COM+, COM-) must share one common power supply.

*2) When driving a load containing inductance (component such as a relay) connect a protection circuit (diode). The motor brake cannot be driven directly. Be sure to use a circuit that interfaces with a diode built-in type relay.

Page 46 Connection to general-purpose output signals

*3) The output circuit configuration is an open collector Darlington transistor output. Connects to relays and optical isolators. Note that when the transistor is on, connector-emitter voltage VCE (SAT) is approximately 1V; a standard TTL IC does not satisfy VIL and cannot be connected directly.

*4) Be sure to connect a termination resistor of approximately 220 Ω.

*5) Make the connection to the communication IC signal ground of the host controller that the drive encoder output signals are connecting to. Connecting signal ground SG to control power GND may result in malfunction.

*6) If Z-phase pulse width is too small to be measured accurately by the host controller, decrease pulse division rate by using pulse output ratio (parameters No.276,0 and No.278,0) or decrease rotational speed to increase the pulse width.

$$\text{Pulse width [ms]} = 2 / \text{rotational speed [rpm]} / (\text{division ratio} \times 2^{17}) \times 60 \times 1,000.$$

2. Position Control Mode

Differential, I/O Setting Option 1



Pinout Diagram

| Command Input | | Encoder Output | | RS-485 Communication | |
|---------------|--|----------------|----------------------------|----------------------|----------------------------|
| Pin No. | Signal Description | Pin No. | Signal Description | Pin No. | Signal Description |
| 26 | CMD_PLS Pulse, QEP A-phase or CCW | 36 | OUT_A A-phase | 44 | /485 /Data |
| 27 | /CMD_PLS /Pulse, QEP /A-phase or /CCW | 37 | /OUT_A /A-phase | 43 | 485 Data |
| 30 | CMD_DIR Direction, QEP B-phase or CW | 38 | OUT_B B-phase | 45 | SG Signal ground |
| 31 | /CMD_DIR /Direction, QEP /B-phase or /CW | 39 | /OUT_B /B-phase | | |
| | QEP: Quadrature encoder pulse | 40 | OUT_Z Z-phase | | |
| | | 41 | /OUT_Z /Z-phase | | |
| | | 42 | SG Signal ground | | |

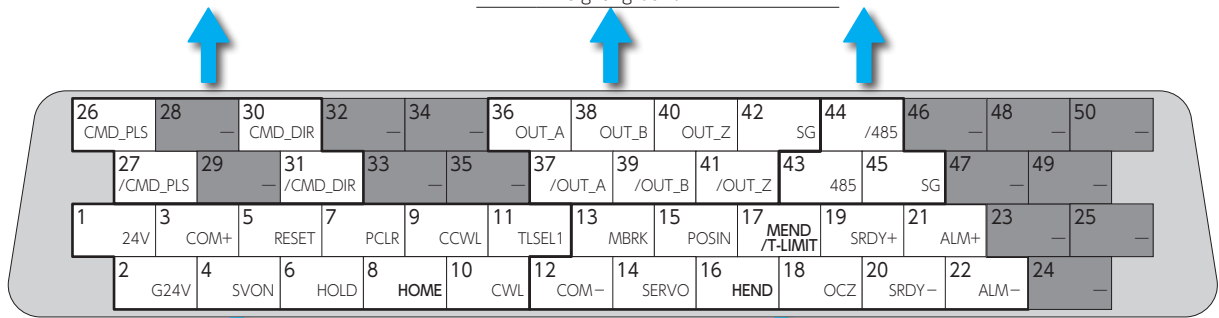

I/O Connector pinout looking at the pins to be soldered

| General-Purpose Input | |
|-----------------------|---|
| Pin No. | Signal Description |
| 1 | 24V Control power 24V |
| 2 | G24V Control power GND |
| 3 | COM+ I/O Power 24V |
| 4 | SVON Servo ON |
| 5 | RESET Alarm reset |
| 6 | HOLD Command input prohibited |
| 7 | PCLR Position Error counter clear |
| 8 | HOME* Homing start |
| 9 | CCWL CCW drive limit switch input |
| 10 | CWL CW drive limit switch input |
| 11 | TLSEL1 Torque Limit |

| General-Purpose Output | |
|------------------------|---|
| Pin No. | Signal Description |
| 12 | COM - I/O power GND |
| 13 | MBRK Motor Brake release |
| 14 | SERVO Servo status |
| 15 | POSIN Positioning complete |
| 16 | HEND* Homing complete |
| 17 | MEND/T-LIMIT* Motion complete/Torque limiting |
| 18 | OCZ Encoder Z-phase (open collector) |
| 19 | SRDY+ Servo ready+ |
| 20 | SRDY - Servo ready |
| 21 | ALM+ Alarm status+ |
| 22 | ALM - Alarm status - |

* For these pins function, change I/O setting with Digitax SF Connect

2. Position Control Mode

CN1 Connector Wiring Example

Pulse Train Command, Differential, I/O Configuration Option 1

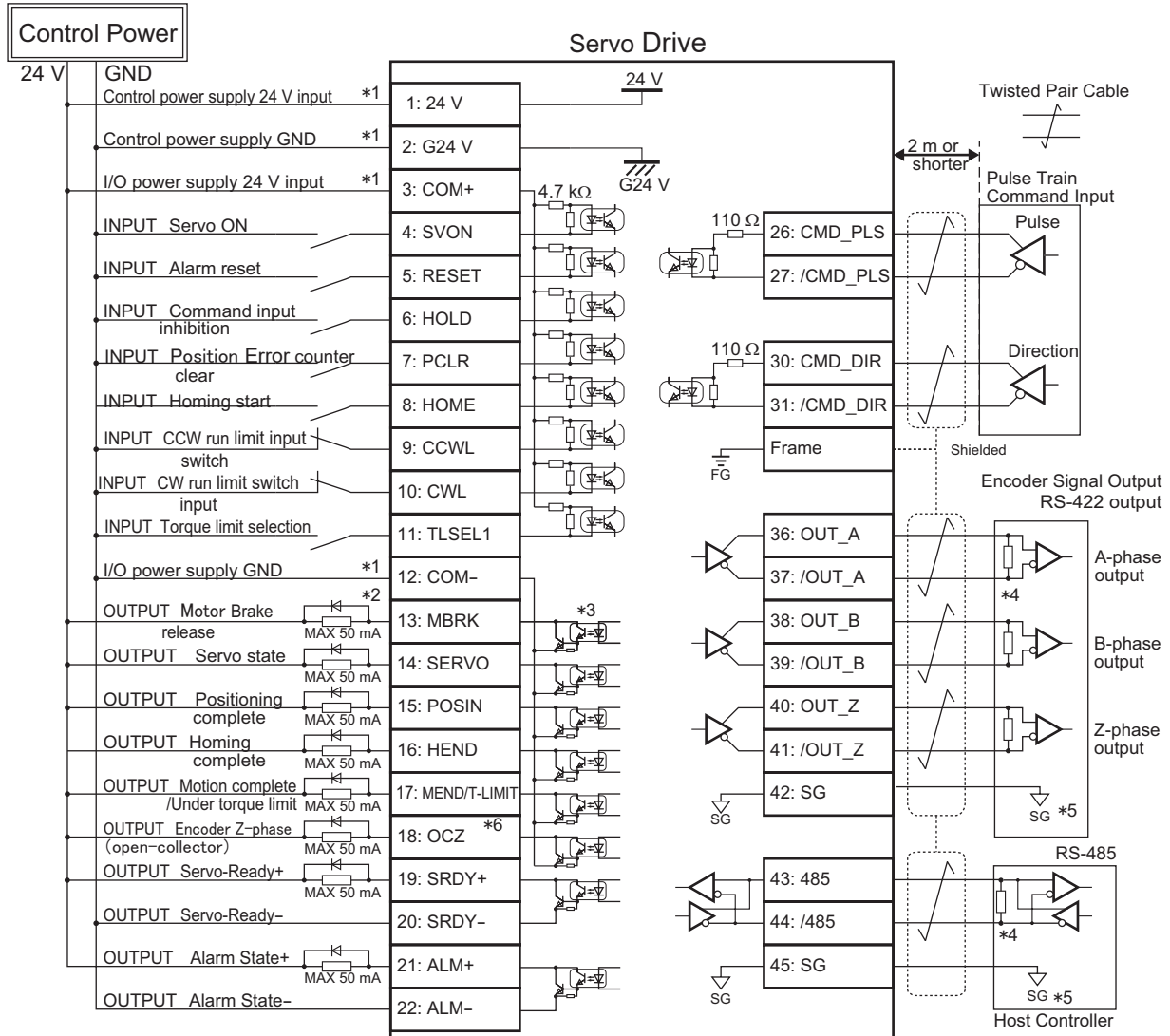

- *1) Control power (24V, G24V) and power for I/O (COM+, COM-) must share one common power supply.
- *2) When driving a load containing inductance (component such as a relay) connect a protection circuit (diode). The motor brake cannot be driven directly. Be sure to use a circuit that interfaces with a diode built-in type relay.
Page 46 Connection to general-purpose output signals
- *3) The output circuit configuration is an open collector Darlington transistor output. Connects to relays and optical isolators. Note that when the transistor is on, connector-emitter voltage VCE (SAT) is approximately 1V; a standard TTL IC does not satisfy VIL and cannot be connected directly.
- *4) Be sure to connect a termination resistor of approximately 220 Ω.
- *5) Make the connection to the communication IC signal ground of the host controller that the drive encoder output signals are connecting to. Connecting signal ground SG to control power GND may result in malfunction.
- *6) If Z-phase pulse width is too small to be measured accurately by the host controller, decrease pulse division rate by using pulse output ratio (parameters No.276,0 and No.278,0) or decrease rotational speed to increase the pulse width.

$$\text{Pulse width [ms]} = 2 / \text{rotational speed [rpm]} / (\text{division ratio} \times 2^{17}) \times 60 \times 1,000.$$

Differential, I/O Setting Option 2



Pinout Diagram

| Command Input | | Encoder Output | | RS-485 Communication | |
|---------------|--|----------------|----------------------------|----------------------|----------------------------|
| Pin No. | Signal Description | Pin No. | Signal Description | Pin No. | Signal Description |
| 26 | CMD_PLS Pulse, QEP A-phase or CCW | 36 | OUT_A A-phase | 44 | /485 /Data |
| 27 | /CMD_PLS /Pulse, QEP /A-phase or /CCW | 37 | /OUT_A /A-phase | 43 | 485 Data |
| 30 | CMD_DIR Direction, QEP B-phase or CW | 38 | OUT_B B-phase | 45 | SG Signal ground |
| 31 | /CMD_DIR /Direction, QEP /B-phase or /CW | 39 | /OUT_B /B-phase | | |
| | QEP: Quadrature encoder pulse | 40 | OUT_Z Z-phase | | |
| | | 41 | /OUT_Z /Z-phase | | |
| | | 42 | SG Signal ground | | |

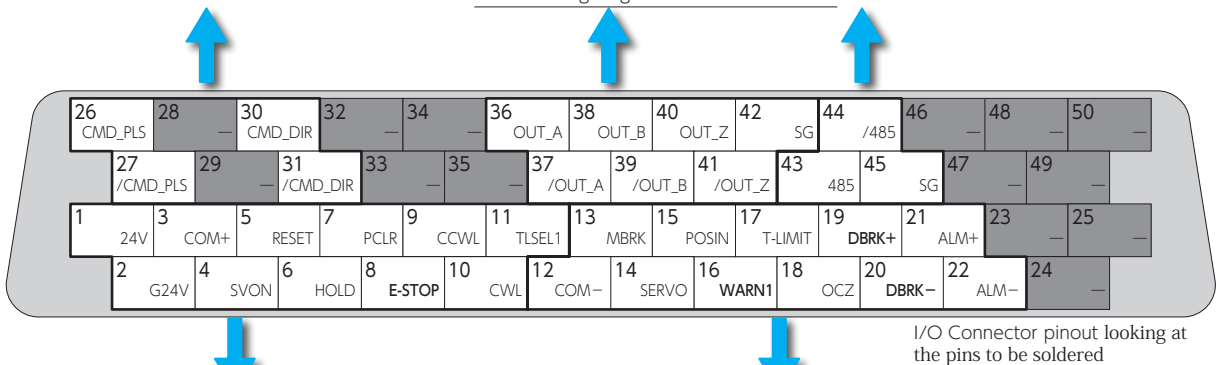

I/O Connector pinout looking at the pins to be soldered

| General-Purpose Input | |
|-----------------------|---|
| Pin No. | Signal Description |
| 1 | 24V Control power 24V |
| 2 | G24V Control power GND |
| 3 | COM+ I/O Power 24V |
| 4 | SVON Servo ON |
| 5 | RESET Alarm reset |
| 6 | HOLD Command input prohibited |
| 7 | PCLR Position Error counter clear |
| 8 | E-STOP * Emergency stop |
| 9 | CCWL CCW drive limit switch input |
| 10 | CWL CW drive limit switch input |
| 11 | TLSEL1 Torque Limit |

| General-Purpose Output | |
|------------------------|---|
| Pin No. | Signal Description |
| 12 | COM - I/O power GND |
| 13 | MBRK Motor Brake release |
| 14 | SERVO Servo status |
| 15 | POSIN Positioning complete |
| 16 | WARN1 * Warning |
| 17 | T-LIMIT Torque Limit |
| 18 | OCZ Encoder Z-phase (open collector) |
| 19 | DBRK+ * Emergency stop brake release+ |
| 20 | DBRK - * Emergency stop brake release - |
| 21 | ALM+ Alarm status+ |
| 22 | ALM - Alarm status - |

* For these pins function, change I/O setting with Digitax SF Connect

2. Position Control Mode

CN1 Connector Wiring Example

Pulse Train Command, Differential, I/O configuration Option 2

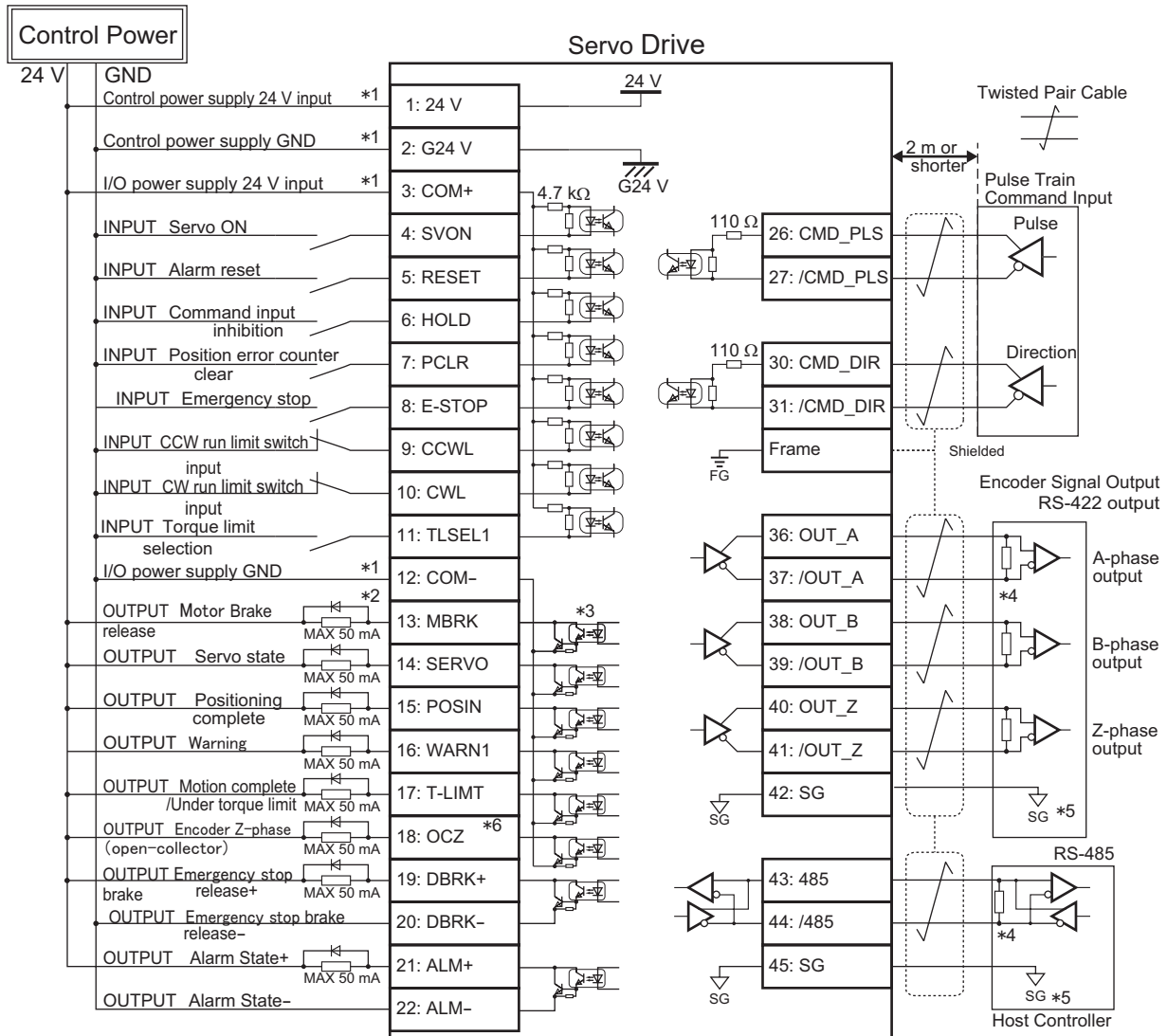

*1) Control power (24V, G24V) and power for I/O (COM+, COM-) must share one common power supply.

*2) When driving a load containing inductance (component such as a relay) connect a protection circuit (diode). The motor brake cannot be driven directly. Be sure to use a circuit that interfaces with a diode built-in type relay.

Page 46 Connection to general-purpose output signals

*3) The output circuit configuration is an open collector Darlington transistor output. Connects to relays and optical isolators. Note that when the transistor is on, connector-emitter voltage VCE (SAT) is approximately 1V; a standard TTL IC does not satisfy VIL and cannot be connected directly.

*4) Be sure to connect a termination resistor of approximately 220 Ω.

*5) Make the connection to the communication IC signal ground of the host controller that the encoder output signals are connecting to. Connecting signal ground SG to control power GND may result in malfunction.

*6) If Z-phase pulse width is too small to be measured accurately by the host controller, decrease pulse division rate by using pulse output ratio (parameters No.276,0 and No.278,0) or decrease rotational speed to increase the pulse width.

$$\text{Pulse width [ms]} = 2 / \text{rotational speed [rpm]} / (\text{division ratio} \times 2^{17}) \times 60 \times 1,000.$$

2. Position Control Mode

24V open collector, Standard I/O configuration



Pinout Diagram

| Command Input | | Encoder Output | | RS-485 Communication | |
|---------------|--|----------------|----------------------------|----------------------|----------------------------|
| Pin No. | Signal Description | Pin No. | Signal Description | Pin No. | Signal Description |
| 27 | /CMD_PLS /Pulse, QEP /A-phase or /CCW | 36 | OUT_A A-phase | 44 | /485 /Data |
| 28 | CC-P Open collector power 24V-PLS | 37 | /OUT_A /A-phase | 43 | 485 Data |
| 29 | CC-D Open collector power 24V-DIR | 38 | OUT_B B-phase | 45 | SG Signal ground |
| 31 | /CMD_DIR /Direction, QEP /B-phase or /CW | 39 | /OUT_B /B-phase | | |
| | QEP: Quadrature encoder pulse | 40 | OUT_Z Z-phase | | |
| | | 41 | /OUT_Z /Z-phase | | |
| | | 42 | SG Signal ground | | |

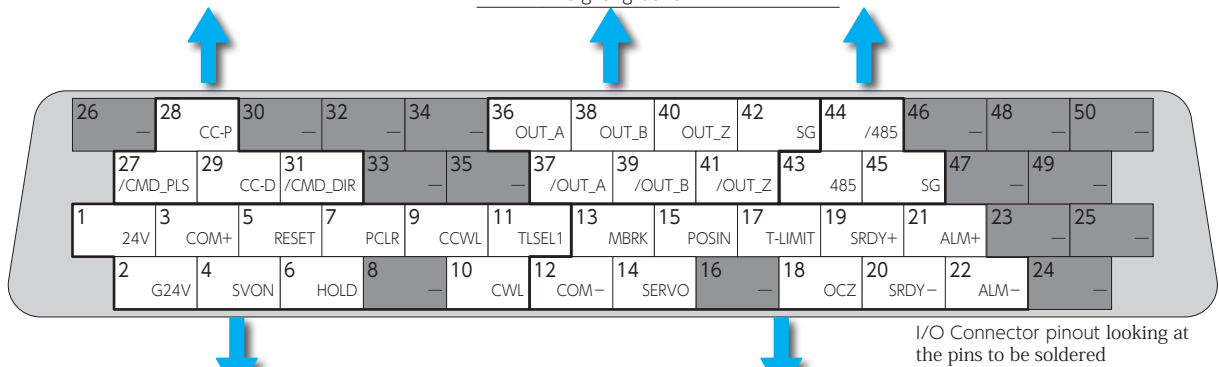

| General-Purpose Input | |
|-----------------------|---|
| Pin No. | Signal Description |
| 1 | 24V Control power 24V |
| 2 | G24V Control power GND |
| 3 | COM+ I/O Power 24V |
| 4 | SVON Servo ON |
| 5 | RESET Alarm reset |
| 6 | HOLD Command input prohibited |
| 7 | PCLR Position Error counter clear |
| 9 | CCWL CCW drive limit switch input |
| 10 | CWL CW drive limit switch input |
| 11 | TLSEL1 Torque Limit |

| General-Purpose Output | |
|------------------------|--|
| Pin No. | Signal Description |
| 12 | COM - I/O power GND |
| 13 | MBRK Brake release |
| 14 | SERVO Servo status |
| 15 | POSIN Positioning complete |
| 17 | T-LIMIT Torque limiting |
| 18 | OCZ Encoder Z-phase (open collector) |
| 19 | SRDY+ Servo ready+ |
| 20 | SRDY - Servo ready - |
| 21 | ALM+ Alarm status+ |
| 22 | ALM - Alarm status - |

2. Position Control Mode

CN1 Connector Wiring Example

Pulse Train Command, 24V Open Collector, Standard I/O Configuration

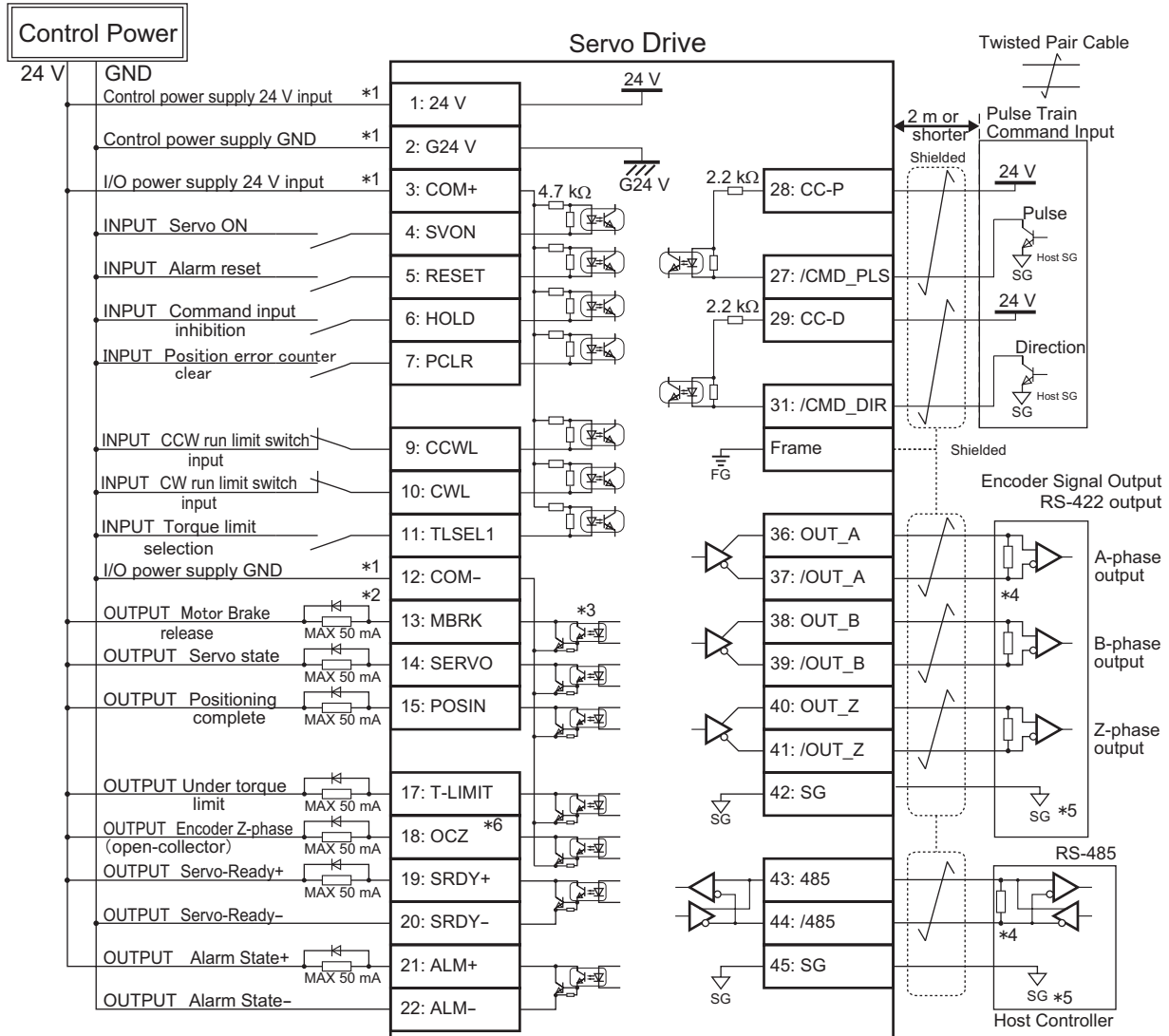

*1) Control power (24V, G24V) and power for I/O (COM+, COM-) must share one common power supply.

*2) When driving a load containing inductance (component such as a relay) connect a protection circuit (diode). The motor brake cannot be driven directly. Be sure to use a circuit that interfaces with a diode built-in type relay.

Page 46 Connection to general-purpose output signals

*3) The output circuit configuration is an open collector Darlington transistor output. Connects to relays and optical isolators. Note that when the transistor is on, connector-emitter voltage VCE (SAT) is approximately 1V; a standard TTL IC does not satisfy VIL and cannot be connected directly.

*4) Be sure to connect a termination resistor of approximately 220 Ω.

*5) Make the connection to the communication IC signal ground of the host controller that the drive encoder output signals are connecting to. Connecting signal ground SG to control power GND may result in malfunction.

*6) If Z-phase pulse width is too small to be measured accurately by the host controller, decrease pulse division rate by using pulse output ratio (parameters No.276,0 and No.278,0) or decrease rotational speed to increase the pulse width.

$$\text{Pulse width [ms]} = 2 / \text{rotational speed [rpm]} / (\text{division ratio} \times 2^{17}) \times 60 \times 1,000.$$

2. Position Control Mode

5V open collector, Standard I/O configuration



Pinout Diagram

| Command Input | | Encoder Output | | RS-485 Communication | |
|---------------|--|----------------|----------------------------|----------------------|----------------------------|
| Pin No. | Signal Description | Pin No. | Signal Description | Pin No. | Signal Description |
| 49 | CC-P_5V_ Open collector power 5V-PLS | 36 | OUT_A A-phase | 44 | /485 /Data |
| 27 | /CMD_PLS /Pulse, QEP /A-phase or /CCW | 37 | /OUT_A /A-phase | 43 | 485 Data |
| 50 | CC-D_5V Open collector power 5V-DIR | 38 | OUT_B B-phase | 45 | SG Signal ground |
| 31 | /CMD_DIR /Direction, QEP /B-phase or /CW | 39 | /OUT_B /B-phase | | |
| | QEP: Quadrature encoder pulse | 40 | OUT_Z Z-phase | | |
| | | 41 | /OUT_Z /Z-phase | | |
| | | 42 | SG Signal ground | | |

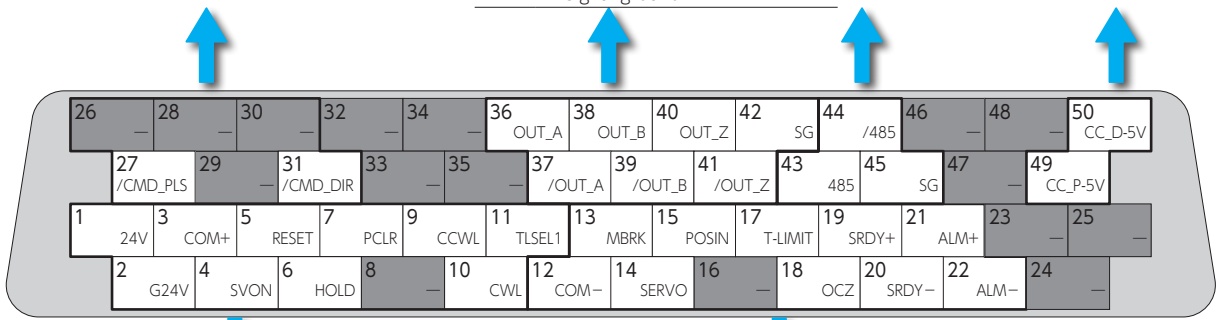

| General-Purpose Input | |
|-----------------------|---|
| Pin No. | Signal Description |
| 1 | 24V Control power 24V |
| 2 | G24V Control power GND |
| 3 | COM+ I/O Power 24V |
| 4 | SVON Servo ON |
| 5 | RESET Alarm reset |
| 6 | HOLD Command input prohibited |
| 7 | PCLR Position Error counter clear |
| 9 | CCWL CCW drive limit switch input |
| 10 | CWL CW drive limit switch input |
| 11 | TLSEL1 Torque Limit |

| General-Purpose Output | |
|------------------------|--|
| Pin No. | Signal Description |
| 12 | COM - I/O power GND |
| 13 | MBRK Motor Brake release |
| 14 | SERVO Servo status |
| 15 | POSIN Positioning complete |
| 17 | T-LIMIT Torque limiting |
| 18 | OCZ Encoder Z-phase (open collector) |
| 19 | SRDY+ Servo ready+ |
| 20 | SRDY - Servo ready - |
| 21 | ALM+ Alarm status+ |
| 22 | ALM - Alarm status - |

2. Position Control Mode

CN1 Connector Wiring Example

Pulse Train Command, 5V Open Collector, Standard I/O Configuration

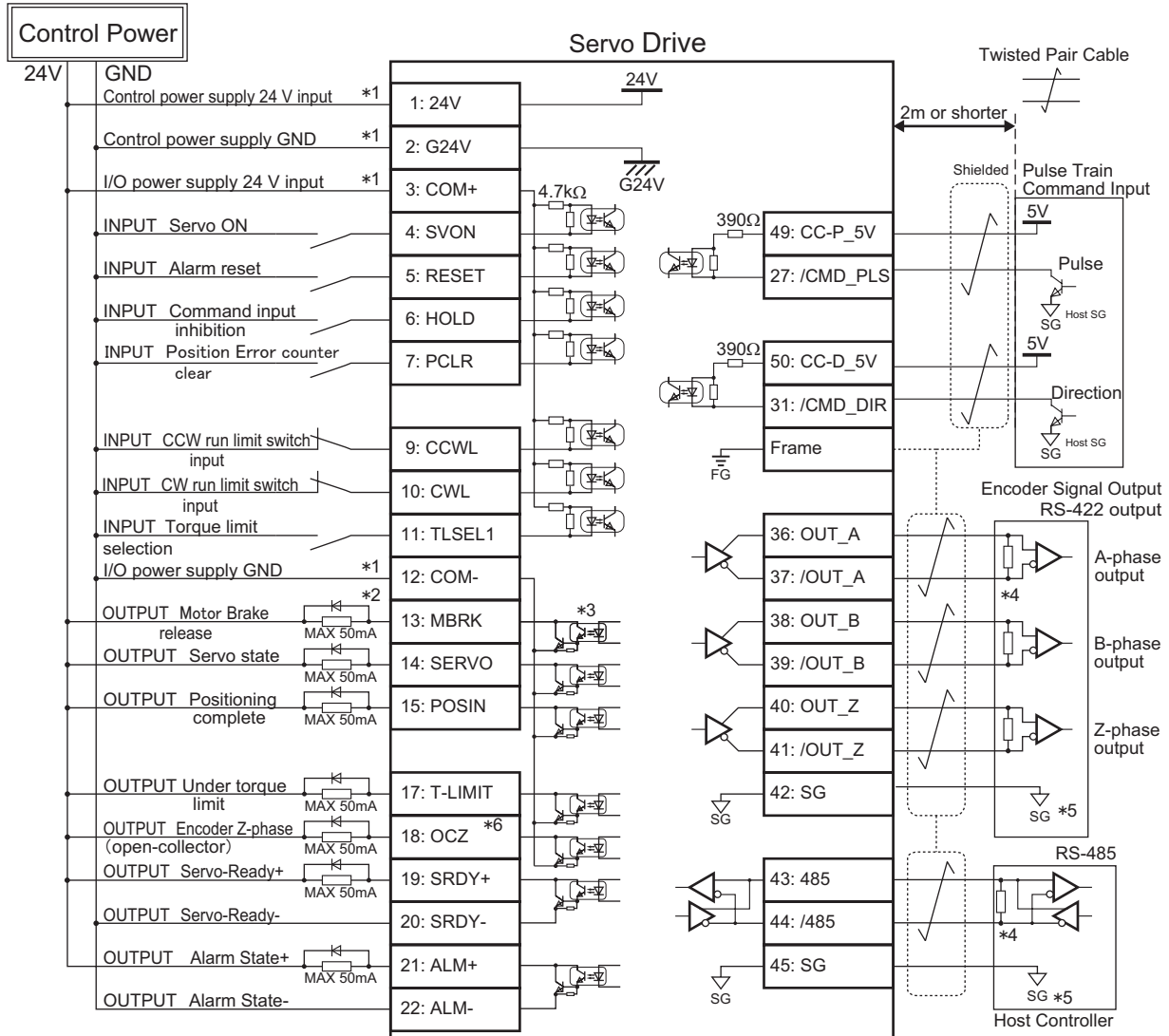

*1) Control power (24V, G24V) and power for I/O (COM+, COM-) must share one common power supply.

*2) When driving a load containing inductance (component such as a relay) connect a protection circuit (diode). The motor brake cannot be driven directly. Be sure to use a circuit that interfaces with a diode built-in type relay.

Page 46 Connection to general-purpose output signals

*3) The output circuit configuration is an open collector Darlington transistor output. Connects to relays and optical isolators. Note that when the transistor is on, connector-emitter voltage VCE (SAT) is approximately 1V; a standard TTL IC does not satisfy VIL and cannot be connected directly.

*4) Be sure to connect a termination resistor of approximately 220 Ω.

*5) Make the connection to the communication IC signal ground of the host controller that the drive encoder output signals are connecting to. Connecting signal ground SG to control power GND may result in malfunction.

*6) If Z-phase pulse width is too small to be measured accurately by the host controller, decrease pulse division rate by using pulse output ratio (parameters No.276,0 and No.278,0) or decrease rotational speed to increase the pulse width.

$$\text{Pulse width [ms]} = 2 / \text{rotational speed [rpm]} / (\text{division ratio} \times 2^{17}) \times 60 \times 1,000.$$

2. Position Control Mode

2. Internal Position Command

Standard I/O Configuration



Pinout Diagram

| Encoder Output | | RS-485 Communication | |
|----------------|----------------------------|----------------------|----------------------------|
| Pin No. | Signal Description | Pin No. | Signal Description |
| 36 | OUT_A A-phase | 44 | /485 /Data |
| 37 | /OUT_A /A-phase | 43 | 485 Data |
| 38 | OUT_B B-phase | 45 | SG Signal ground |
| 39 | /OUT_B /B-phase | | |
| 40 | OUT_Z Z-phase | | |
| 41 | /OUT_Z /Z-phase | | |
| 42 | SG Signal ground | | |

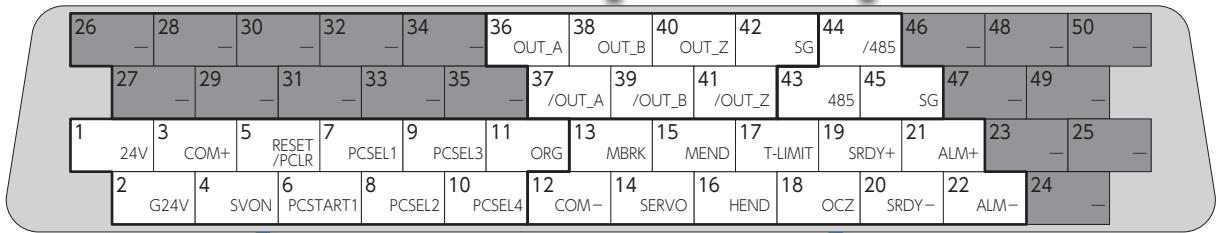

I/O Connector pinout looking at the pins to be soldered

| General-Purpose Input | |
|-----------------------|---|
| Pin No. | Signal Description |
| 1 | 24V Control power 24V |
| 2 | G24V Control power GND |
| 3 | COM+ I/O Power 24V |
| 4 | SVON Servo ON |
| 5 | RESET/PCLR Alarm Reset / Position Error Counter Clear |
| 6 | PCSTART1 Start Forward Rotation |
| 7 | PCSEL1 Point No. Select 1 |
| 8 | PCSEL2 Point No. Select 2 |
| 9 | PCSEL3 Point No. Select 3 |
| 10 | PCSEL4 Point No. Select 4 |
| 11 | ORG Home position sensor |

| General-Purpose Output | |
|------------------------|--|
| Pin No. | Signal Description |
| 12 | COM - I/O power GND |
| 13 | MBRK Motor Brake release |
| 14 | SERVO Servo status |
| 15 | MEND Motion complete |
| 16 | HEND Homing complete |
| 17 | T-LIMIT Torque limiting |
| 18 | OCZ Encoder Z-phase (open collector) |
| 19 | SRDY+ Servo ready+ |
| 20 | SRDY - Servo ready - |
| 21 | ALM+ Alarm status+ |
| 22 | ALM - Alarm status - |

2. Position Control Mode

CN1 Connector Wiring Example

Internal Position Command, Standard I/O Configuration

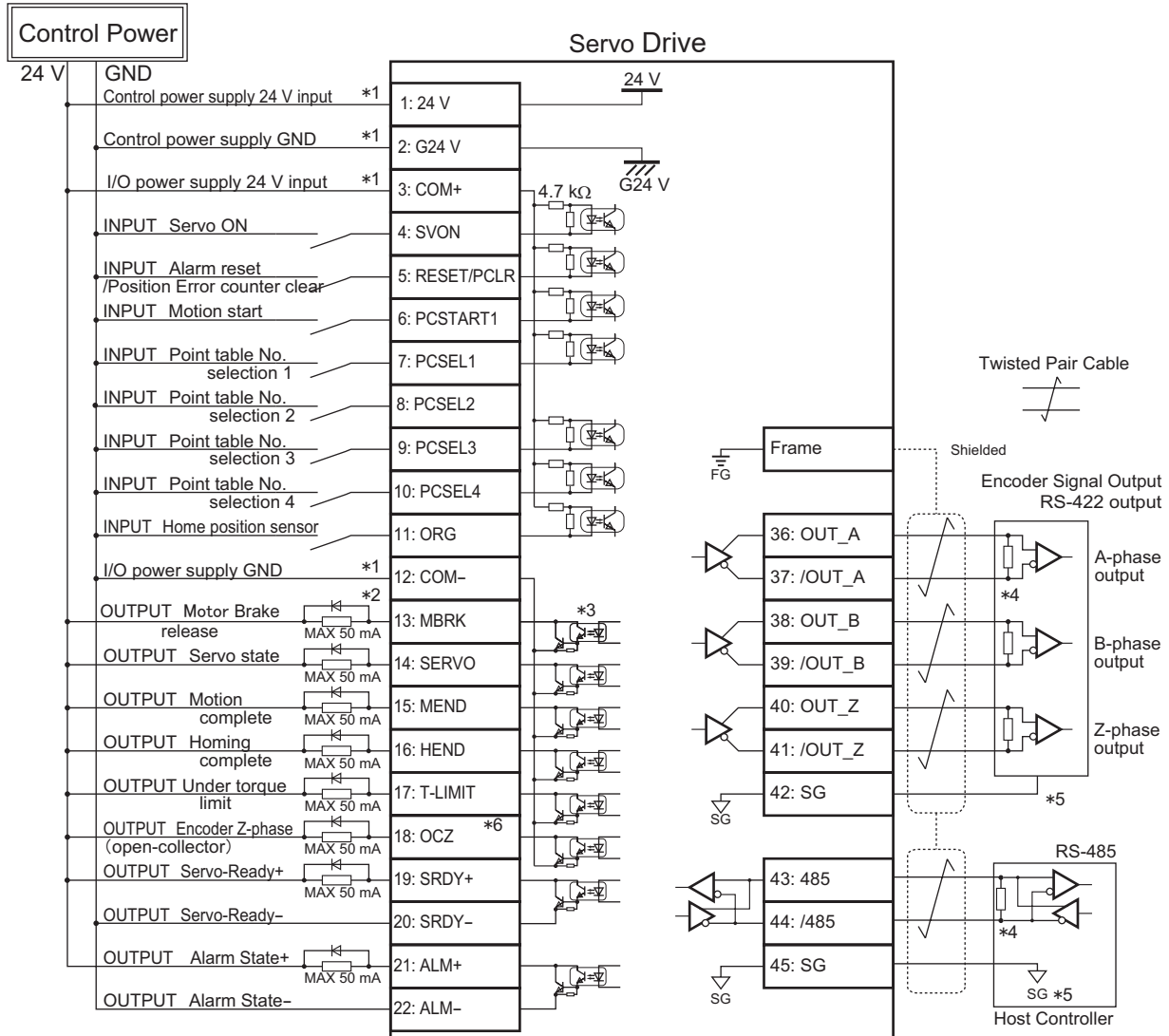

*1) Control power (24V, G24V) and power for I/O (COM+, COM-) must share one common power supply.

*2) When driving a load containing inductance (component such as a relay) connect a protection circuit (diode). The motor brake cannot be driven directly. Be sure to use a circuit that interfaces with a diode built-in type relay.

Page 46 Connection to general-purpose output signals

*3) The output circuit configuration is an open collector Darlington transistor output. Connects to relays and optical isolators. Note that when the transistor is on, connector-emitter voltage VCE (SAT) is approximately 1V; a standard TTL IC does not satisfy VIL and cannot be connected directly.

*4) Be sure to connect a termination resistor of approximately 220 Ω.

*5) Make the connection to the communication IC signal ground of the host controller that the drive encoder output signals are connecting to. Connecting signal ground SG to control power GND may result in malfunction.

*6) If Z-phase pulse width is too small to be measured accurately by the host controller, decrease pulse division rate by using pulse output ratio (parameters No.276,0 and No.278,0) or decrease rotational speed to increase the pulse width.

$$\text{Pulse width [ms]} = 2 / \text{rotational speed [rpm]} / (\text{division ratio} \times 2^{17}) \times 60 \times 1,000.$$

Optional I/O Configuration



Pinout Diagram

| Encoder Output | | RS-485 Communication | |
|----------------|----------------------------|----------------------|----------------------------|
| Pin No. | Signal Description | Pin No. | Signal Description |
| 36 | OUT_A A-phase | 44 | /485 /Data |
| 37 | /OUT_A /A-phase | 43 | 485 Data |
| 38 | OUT_B B-phase | 45 | SG Signal ground |
| 39 | /OUT_B /B-phase | | |
| 40 | OUT_Z Z-phase | | |
| 41 | /OUT_Z /Z-phase | | |
| 42 | SG Signal ground | | |

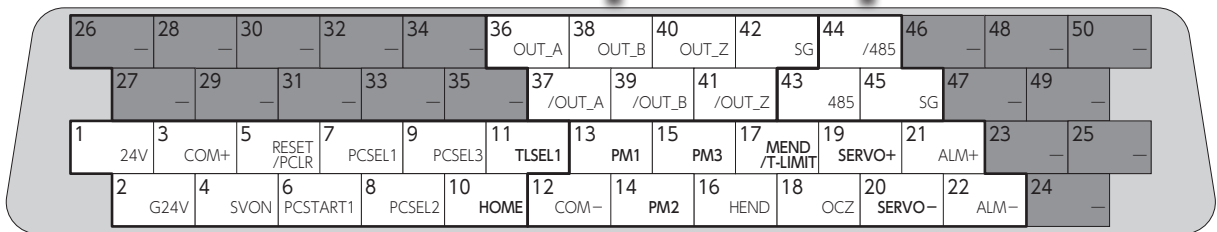

I/O Connector pinout looking at the pins to be soldered

| General-Purpose Input | |
|-----------------------|---|
| Pin No. | Signal Description |
| 1 | 24V Control power 24V |
| 2 | G24V Control power GND |
| 3 | COM+ I/O Power 24V |
| 4 | SVON Servo ON |
| 5 | RESET/PCLR Alarm Reset/Position error Counter Clear |
| 6 | PCSTART1 Start Forward Rotation |
| 7 | PCSEL1 Point No. Select 1 |
| 8 | PCSEL2 Point No. Select 2 |
| 9 | PCSEL3 Point No. Select 3 |
| 10 | HOME * Homing start |
| 11 | TLSEL1 * Torque limit |

| General-Purpose Output | |
|------------------------|--|
| Pin No. | Signal Description |
| 12 | COM - I/O power GND |
| 13 | PM1 * Point No.1 |
| 14 | PM2 * Point No.2 |
| 15 | PM3 * Point No.3 |
| 16 | HEND Homing complete |
| 17 | MEND/T-LIMIT * Motion Complete/Torque Limiting |
| 18 | OCZ Encoder Z-phase (open collector) |
| 19 | SERVO+ * Servo Status+ |
| 20 | SERVO - * Servo Status - |
| 21 | ALM+ Alarm status+ |
| 22 | ALM - Alarm status - |

* For these pins function, change I/O setting with Digitax SF Connect

2. Position Control Mode

CN1 Connector Wiring Example

Internal Position Command, Optional I/O Configuration

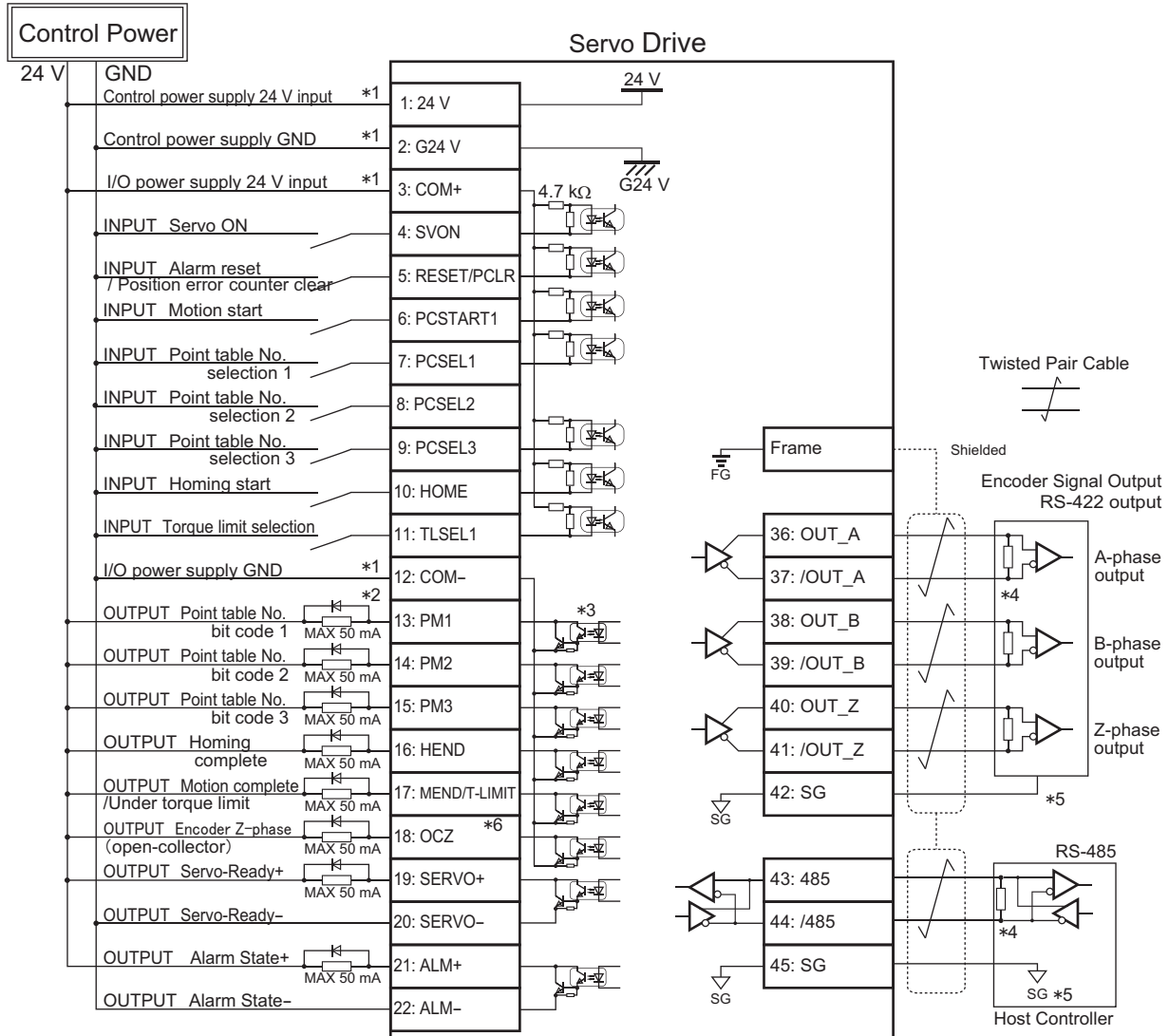

*1) Control power (24V, G24V) and power for I/O (COM+, COM-) must share one common power supply.

*2) When driving a load containing inductance (component such as a relay) connect a protection circuit (diode).
The motor brake cannot be driven directly. Be sure to use a circuit that interfaces with a diode built-in type relay.

Page 46 Connection to general-purpose output signals

*3) The output circuit configuration is an open collector Darlington transistor output. Connects to relays and optical isolators.
Note that when the transistor is on, connector-emitter voltage VCE (SAT) is approximately 1V;
a standard TTL IC does not satisfy VIL and cannot be connected directly.

*4) Be sure to connect a termination resistor of approximately 220 Ω.

*5) Make the connection to the communication IC signal ground of the host controller that the drive encoder output signals are connecting to. Connecting signal ground SG to control power GND may result in malfunction.

*6) If Z-phase pulse width is too small to be measured accurately by the host controller, decrease pulse division rate by using pulse output ratio (parameters No.276,0 and No.278,0) or decrease rotational speed to increase the pulse width.

$$\text{Pulse width [ms]} = 2 / \text{rotational speed [rpm]} / (\text{division ratio} \times 2^{17}) \times 60 \times 1,000.$$



Pinout Diagram

| Command Input | | Encoder Output | | RS-485 Communication | |
|---------------|---------------------------------------|----------------|----------------------------|----------------------|----------------------------|
| Pin No. | Signal Description | Pin No. | Signal Description | Pin No. | Signal Description |
| 32 | A_SPEED Analog Command | 36 | OUT_A A-phase | 44 | /485 /Data |
| 33 | A_GND Analog Command Ground | 37 | /OUT_A /A-phase | 43 | 485 Data |
| | | 38 | OUT_B B-phase | 45 | SG Signal ground |
| | | 39 | /OUT_B /B-phase | | |
| | | 40 | OUT_Z Z-phase | | |
| | | 41 | /OUT_Z /Z-phase | | |
| | | 42 | SG Signal ground | | |

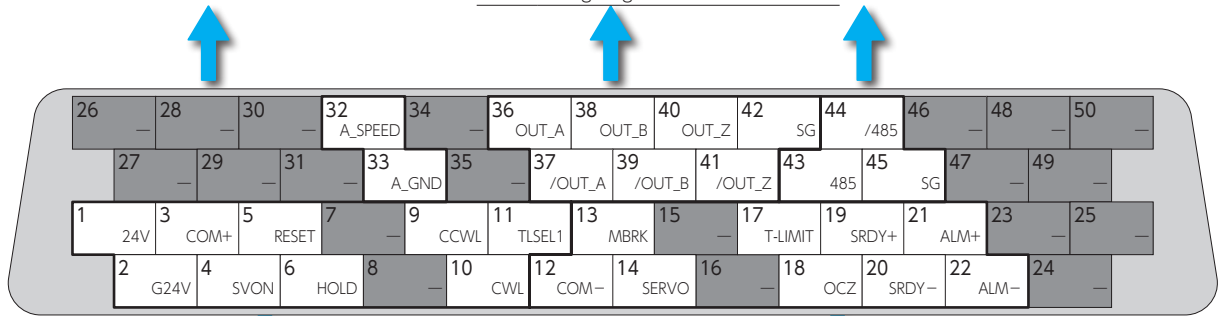

I/O Connector pinout looking at the pins to be soldered

| General-Purpose Input | |
|-----------------------|---|
| Pin No. | Signal Description |
| 1 | 24V Control power 24V |
| 2 | G24V Control power GND |
| 3 | COM+ I/O Power 24V |
| 4 | SVON Servo ON |
| 5 | RESET Alarm reset |
| 6 | HOLD Command input prohibited |
| 9 | CCWL CCW drive limit switch input |
| 10 | CWL CW drive limit switch input |
| 11 | TLSEL1 Torque Limit |

| General-Purpose Output | |
|------------------------|--|
| Pin No. | Signal Description |
| 12 | COM - I/O power GND |
| 13 | MBRK Motor Brake release |
| 14 | SERVO Servo status |
| 17 | T-LIMIT Torque limiting |
| 18 | OCZ Encoder Z-phase (open collector) |
| 19 | SRDY+ Servo ready+ |
| 20 | SRDY - Servo ready - |
| 21 | ALM+ Alarm status+ |
| 22 | ALM - Alarm status - |

3. Velocity Control Mode

CN1 Connector Wiring Example

Analog Velocity Command

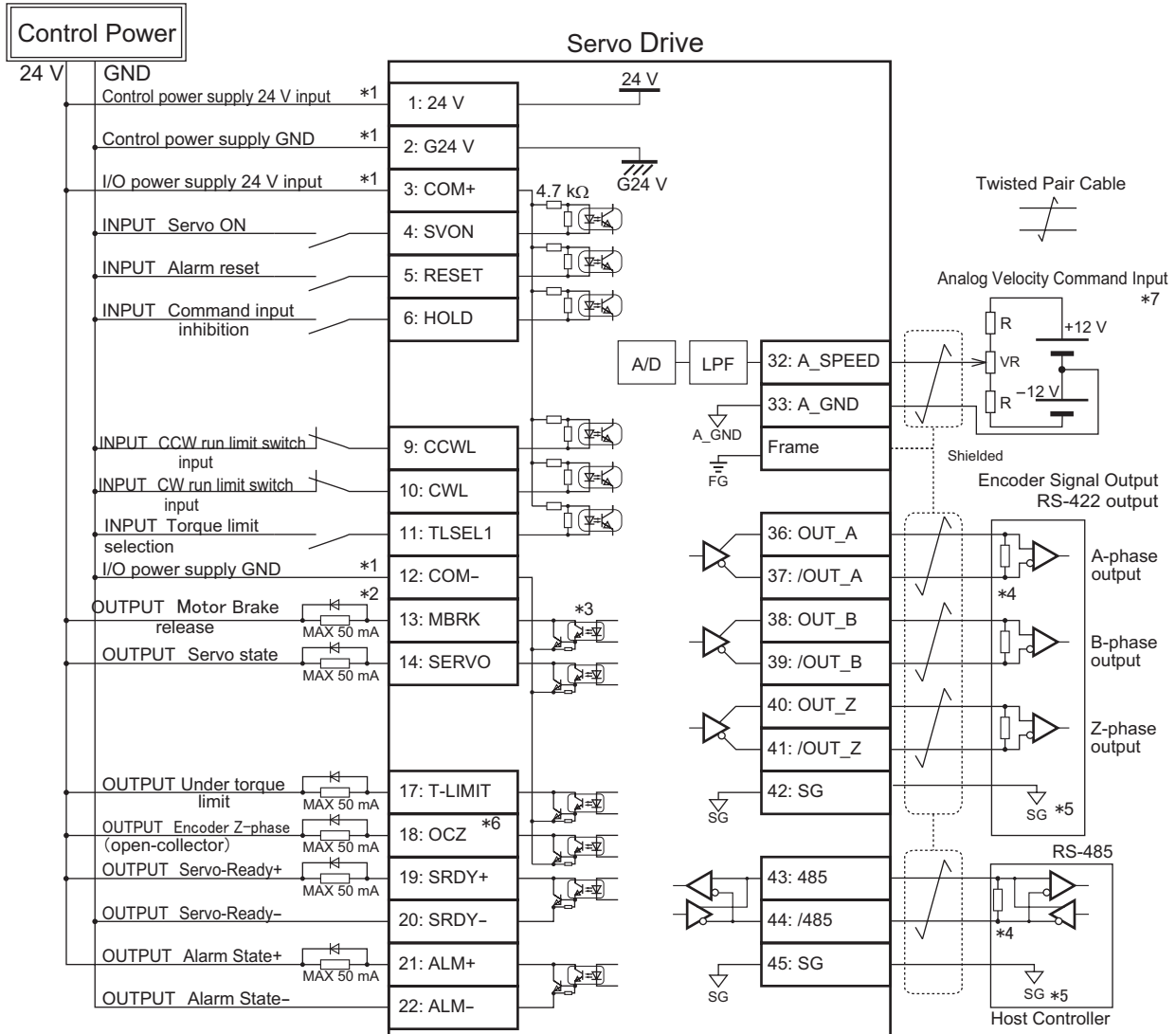

*1) Control power (24V, G24V) and power for I/O (COM+, COM-) must share one common power supply.

*2) When driving a load containing inductance (component such as a relay) connect a protection circuit (diode). The motor brake cannot be driven directly. Be sure to use a circuit that interfaces with a diode built-in type relay.

Page 46 Connection to general-purpose output signals

*3) The output circuit configuration is an open collector Darlington transistor output. Connects to relays and optical isolators. Note that when the transistor is on, connector-emitter voltage VCE (SAT) is approximately 1V; a standard TTL IC does not satisfy VIL and cannot be connected directly.

*4) Be sure to connect a termination resistor of approximately 220 Ω.

*5) Make the connection to the communication IC signal ground of the host controller that the drive encoder output signals are connecting to. Connecting signal ground SG to control power GND may result in malfunction.

*6) If Z-phase pulse width is too small to be measured accurately by the host controller, decrease pulse division rate by using pulse output ratio (parameters No.276,0 and No.278,0) or decrease rotational speed to increase the pulse width.

$$\text{Pulse width [ms]} = 2 / \text{rotational speed [rpm]} / (\text{division ratio} \times 2^i) \times 60 \times 1,000.$$

*7) For the command circuit configuration with a variable resistor (VR) and a resistor (R), VR must be 2kΩ (1/4W or more) and R must be 100Ω to 200Ω (1/4W or more), so that command input voltage range is -10V to +10V. If the analog velocity command circuit of the host controller is isolated from 24V control power supply, connect A_GND to signal ground of the host controller, not to GND of control power. If the analog velocity command circuit is not isolated, connect A_GND to GND of control power.

3. Velocity Control Mode

2. Internal Velocity Command



Pinout Diagram

| Encoder Output | | RS-485 Communication | |
|----------------|----------------------------|----------------------|----------------------------|
| Pin No. | Signal Description | Pin No. | Signal Description |
| 36 | OUT_A A-phase | 44 | /485 /Data |
| 37 | /OUT_A /A-phase | 43 | 485 Data |
| 38 | OUT_B B-phase | 45 | SG Signal ground |
| 39 | /OUT_B /B-phase | | |
| 40 | OUT_Z Z-phase | | |
| 41 | /OUT_Z /Z-phase | | |
| 42 | SG Signal ground | | |

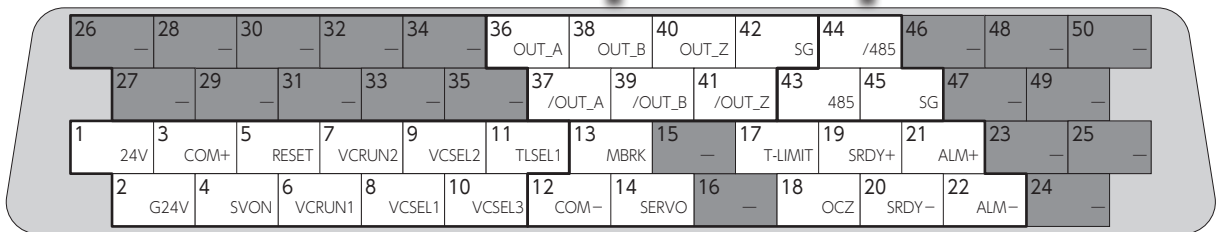

I/O Connector pinout looking at the pin to be soldered

| General-Purpose Input | |
|-----------------------|---|
| Pin No. | Signal Description |
| 1 | 24V Control power 24V |
| 2 | G24V Control power GND |
| 3 | COM+ I/O Power 24V |
| 4 | SVON Servo ON |
| 5 | RESET Alarm reset |
| 6 | VCRUN1 Start 1 (CCW rotation) |
| 7 | VCRUN2 Start 2 (CW rotation) |
| 8 | VCSEL1 Speed Select 1 |
| 9 | VCSEL2 Speed Select 2 |
| 10 | VCSEL3 Speed Select 3 |
| 11 | TLSEL1 Torque Limit |

| General-Purpose Output | |
|------------------------|--|
| Pin No. | Signal Description |
| 12 | COM - I/O power GND |
| 13 | MBRK Motor Brake release |
| 14 | SERVO Servo status |
| 17 | T-LIMIT Torque limiting |
| 18 | OCZ Encoder Z-phase (open collector) |
| 19 | SRDY+ Servo ready+ |
| 20 | SRDY - Servo ready - |
| 21 | ALM+ Alarm status+ |
| 22 | ALM - Alarm status - |

3. Velocity Control Mode

CN1 Connector Wiring Example

Internal Velocity Command

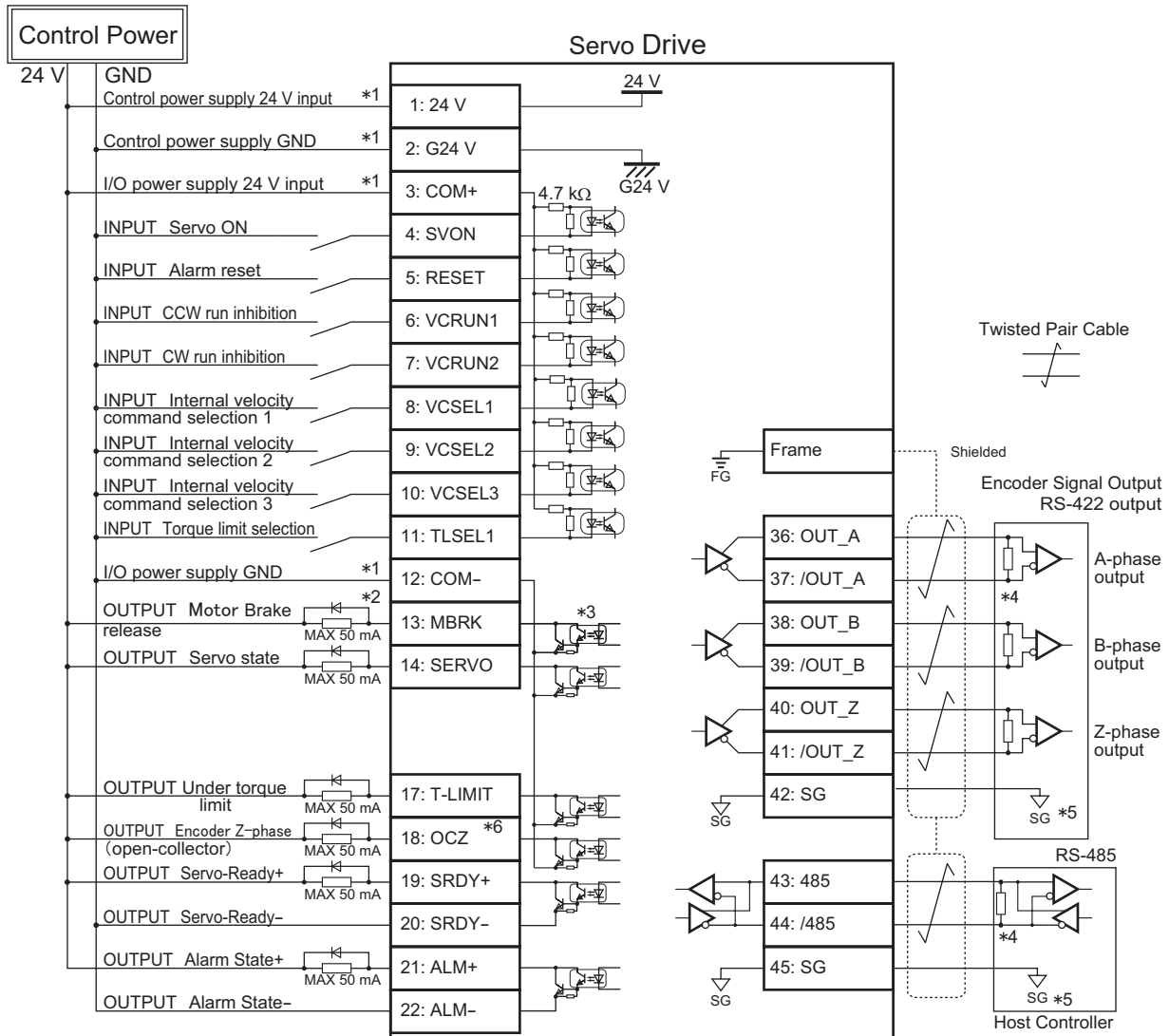

*1) Control power (24V, G24V) and power for I/O (COM+, COM-) must share one common power supply.

*2) When driving a load containing inductance (component such as a relay) connect a protection circuit (diode). The motor brake cannot be driven directly. Be sure to use a circuit that interfaces with a diode built-in type relay.

Page 46 Connection to general-purpose output signals

*3) The output circuit configuration is an open collector Darlington transistor output. Connects to relays and optical isolators. Note that when the transistor is on, connector-emitter voltage VCE (SAT) is approximately 1V; a standard TTL IC does not satisfy VIL and cannot be connected directly.

*4) Be sure to connect a termination resistor of approximately 220 Ω.

*5) Make the connection to the communication IC signal ground of the host controller that the drive encoder output signals are connecting to. Connecting signal ground SG to control power GND may result in malfunction.

*6) If Z-phase pulse width is too small to be measured accurately by the host controller, decrease pulse division rate by using pulse output ratio (parameters No.276,0 and No.278,0) or decrease rotational speed to increase the pulse width.

$$\text{Pulse width [ms]} = 2 / \text{rotational speed [rpm]} / (\text{division ratio} \times 2^{17}) \times 60 \times 1,000.$$

4. Connections

4. Torque Control Mode

1. Analog Torque Command



Pinout Diagram

| Command Input | | Encoder Output | | RS-485 Communication | |
|---------------|---------------------------------------|----------------|----------------------------|----------------------|----------------------------|
| Pin No. | Signal Description | Pin No. | Signal Description | Pin No. | Signal Description |
| 32 | A_TRQ Analog Command | 36 | OUT_A A-phase | 44 | /485 /Data |
| 33 | A_GND Analog Command Ground | 37 | /OUT_A /A-phase | 43 | 485 Data |
| | | 38 | OUT_B B-phase | 45 | SG Signal ground |
| | | 39 | /OUT_B /B-phase | | |
| | | 40 | OUT_Z Z-phase | | |
| | | 41 | /OUT_Z /Z-phase | | |
| | | 42 | SG Signal ground | | |

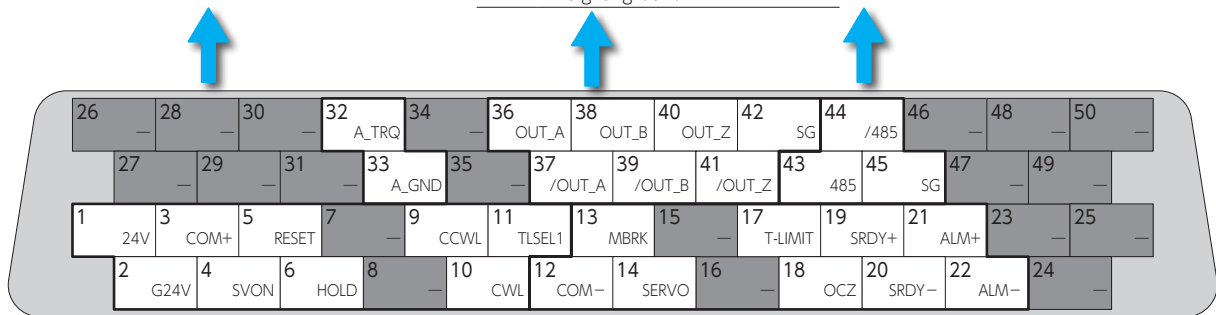

I/O Connector pinout looking at the pins to be soldered

| General-Purpose Input | |
|-----------------------|---|
| Pin No. | Signal Description |
| 1 | 24V Control power 24V |
| 2 | G24V Control power GND |
| 3 | COM+ I/O Power 24V |
| 4 | SVON Servo ON |
| 5 | RESET Alarm reset |
| 6 | HOLD Command input prohibited |
| 9 | CCWL CCW drive limit input switch |
| 10 | CWL CW drive limit input switch |
| 11 | TLSEL1 Torque Limit |

| General-Purpose Output | |
|------------------------|--|
| Pin No. | Signal Description |
| 12 | COM - I/O power GND |
| 13 | MBRK Motor Brake release |
| 14 | SERVO Servo status |
| 17 | T-LIMIT Torque limiting |
| 18 | OCZ Encoder Z-phase (open collector) |
| 19 | SRDY+ Servo ready+ |
| 20 | SRDY - Servo ready - |
| 21 | ALM+ Alarm status+ |
| 22 | ALM - Alarm status - |

4. Torque Control Mode

CN1 Connector Wiring Example

Analog Torque Command

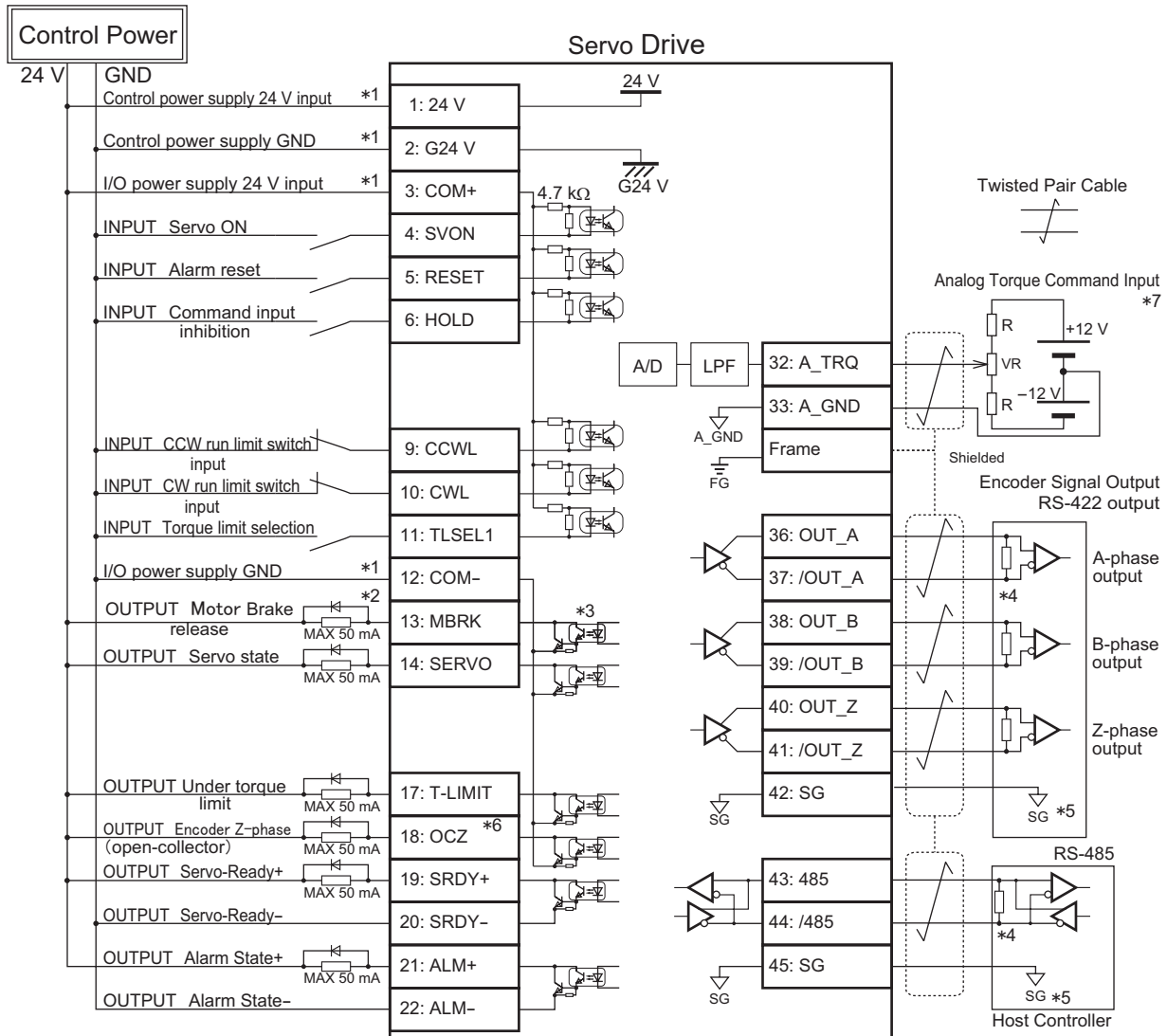

*1) Control power (24V, G24V) and power for I/O (COM+, COM-) must share one common power supply.

*2) When driving a load containing inductance (component such as a relay) connect a protection circuit (diode). The motor brake cannot be driven directly. Be sure to use a circuit that interfaces with a diode built-in type relay.

Page 46 Connection to general-purpose output signals

*3) The output circuit configuration is an open collector Darlington transistor output. Connects to relays and optical isolators. Note that when the transistor is on, connector-emitter voltage VCE (SAT) is approximately 1V; a standard TTL IC does not satisfy VIL and cannot be connected directly.

*4) Be sure to connect a termination resistor of approximately 220 Ω.

*5) Make the connection to the communication IC signal ground of the host controller that the drive encoder output signals are connecting to. Connecting signal ground SG to control power GND may result in malfunction.

*6) If Z-phase pulse width is too small to be measured accurately by the host controller, decrease pulse division rate by using pulse output ratio (parameters No.276,0 and No.278,0) or decrease rotational speed to increase the pulse width.

$$\text{Pulse width [ms]} = 2 / \text{rotational speed [rpm]} / (\text{division ratio} \times 2^i) \times 60 \times 1,000.$$

*7) For the command circuit configuration with a variable resistor (VR) and a resistor (R), VR must be 2kΩ (1/4W or more) and R must be 100Ω to 200Ω (1/4W or more), so that command input voltage range is -10V to +10V. If the analog velocity command circuit of the host controller is isolated from 24V control power supply, connect A_GND to signal ground of the host controller, not to GND of control power. If the analog velocity command circuit is not isolated, connect A_GND to GND of control power.

5. Descriptions of CN1 Connector Signals

1. Descriptions of CN1 Connector Signals

Each pin assignment of CN1 connector varies depending on the Control Mode/Command Mode. Review the functions of each pin before using the product.

Pins marked with this icon enable you to change the input/output logic. The logic is changed on the I/O tab of the auxiliary functions section in Digitax SF connect. Changing the logic setting acts as a software invert on the signal only

Pin number on CN1

For the diagram, refer to this page

Related Control modes
P: Position control
V: Velocity control
T: Torque control

| Pin No. | Signal | Interface Circuit | Control Mode | | |
|---------|--------------------------------|---|--------------|---|---|
| | | | P | S | T |
| 9 | CCWL CCW drive limit switch | <p>Open</p> <p>Prohibits CCW motion</p> <p>Close</p> <p>Allows CCW motion.</p> <p>■ TIP Make the connection such that COM- becomes open when the equipment moves beyond the CCW motion range.</p> <p>■ Related Parameters ·No.67.0 Restriction enabled when "2: Enable CCW drive limit switch" or "3: Enable CW/CCW drive limit switch" is selected. ·No.67.1 Enables you to specify the deceleration method. The initial setting is 1 (short brake). ·No.67.2 Enables you to specify the status after the motor stops. The initial setting is 0 (coast to stop). ·No.67.3 You can select keep or clear the position error counter data. The initial setting is "0: keep" .</p> | | | |
| | PCSEL3 Point No. Select 3 | <p>Open / Close</p> <p>You can specify the Point No. with a combination of PCSEL1 ...PCSEL4.</p> <p>☞ PCSEL1 (Pin No.7)</p> | | | |
| | VCSEL2 Speed Select 2 | <p>Open / Close</p> <p>You can select the target speed setting with a combination of VCSEL1 ...VCSEL3.</p> <p>☞ VCSEL1 (Pin No.8)</p> | | | |

Indicates signal behaviours.

Input
Open : No contact with COM-
Closed: Contact with COM-

Output
Open : Output transistor OFF
Closed: Output transistor ON

Reference to information about pins with duplicated functions.







If the signal function varies depending on the control or command mode selection, all functions are listed.







The corresponding command mode is shown.

| Icon | Control Mode Command | Icon | Control Mode Command |
|------|--|------|--|
| | Position Control Mode Differential | | Velocity Control Mode Analog Velocity Command |
| | Position Control Mode 24V open collector | | Velocity Control Mode Internal Velocity Command |
| | Position Control Mode 5V open collector | | Torque Control Mode Analog Torque Command |
| | Position Control Mode Internal Position Command | | |

5. Descriptions of CN1 Connector Signals







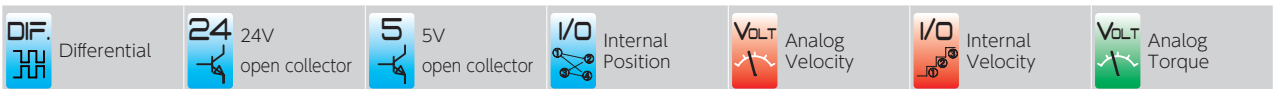









General-Purpose Input

| Pin No. | 1, 3 | Interface Circuit | PS (page 45) | Control Mode | | |
|--|---|-------------------|--------------|--|--|---|
| Signal | Description | | | P | S | T |
| 24V (Pin No.1) Control power 24V | Connect to the positive pole of the external DC power supply. Power voltage: DC24V ± 10% Use SELV power supply with reinforced insulation that is isolated from hazardous voltages. COM+ and G24V drive control power must share one common power supply. 24V: Drive control power COM+ : A common power supply for optical isolators of general-purpose input circuits. | | |     |   |  |
| COM+ (Pin No.3) I/O Power 24V | | | | | | |











| Pin No. | 2 | Interface Circuit | PS (page 45) | Control Mode | | |
|----------------------------------|---|-------------------|--------------|--|--|---|
| Signal | Description | | | P | S | T |
| G24V Control power GND | Drive control power. Connect to the negative pole of the external DC power supply. Power voltage: DC24V ± 10% Use SELV power supply with reinforced insulation that is isolated from hazardous voltages. | | |     |   |  |











5. Descriptions of CN1 Connector Signals

| Pin No. | 4 | Interface Circuit | PI (page 45) | Control Mode | | |
|--|--|-------------------|--------------|--|--|---|
| Signal | Description | | | P | S | T |
|  SVON Servo ON | <div style="border: 1px solid gray; padding: 2px; display: inline-block; margin-bottom: 5px;">Open</div> Turns the servo OFF. <div style="border: 1px solid gray; padding: 2px; display: inline-block; margin-top: 5px;">Close</div> Turns the servo ON. | | |     |   |  |
|  RESET Alarm Reset | <div style="border: 1px solid gray; padding: 2px; display: inline-block; margin-bottom: 5px;">Close</div> Resets an alarm. <ul style="list-style-type: none"> ■ TIP ■ Be sure to turn off this signal after alarm reset execution. ■ Encoder-, product code-, and system- alarms are not reset by this signal. ■ You must cycle control power of the drive. | | |    |   |  |
|  RESET/PCLR Alarm Clear / Position Error Counter Clear | <div style="border: 1px solid gray; padding: 2px; display: inline-block; margin-bottom: 5px;">Close</div> Clears Alarm and Error counter. <ul style="list-style-type: none"> ■ Related parameters No. 67.3 | | |  | | |











5. Descriptions of CN1 Connector Signals

| Pin No. | Signal | Interface Circuit | PI (page 45) | Control Mode | | | | | | | | | | | | | | | | | |
|--------------------------------------|---|--|--------------------------------------|---|---|---|---|-------------------------------|----|-------------------------------|---|------------|-------------------------------|-------------------------------|------------|---|---|--|---|--|--|
| | | | | P | S | T | | | | | | | | | | | | | | | |
| 6 |  <p>HOLD Command input prohibit (Position Control mode) Zero command clamp (Velocity Control mode, Torque Control mode)</p> | <p><input type="checkbox"/> Open</p> <p>Allows command input.</p> <p><input checked="" type="checkbox"/> Close</p> <p>Prohibits command input. Until command input becomes allowed, the motor does not move regardless of the state of the command inputs.</p> <p>■ Related Parameter •No.67.3</p> <p>In Position Control mode, you can select whether the pulse counter data to is be maintained while command input is prohibited.</p> | |    |  |  | | | | | | | | | | | | | | | |
| |  <p>PCSTART1 Start Forward Rotation</p> | <p><input checked="" type="checkbox"/> Close</p> <p>Starts motor operation. Executes Motion or Homing per Point No. specified with PCSEL1...4.</p> <p>■ TIP Be sure to turn off this signal after the motion is completed.</p> | |  | | | | | | | | | | | | | | | | | |
| |  <p>VCRUN1 Internal velocity Start 1</p> | <p><input checked="" type="checkbox"/> Close</p> <p>Motor rotates in CCW direction</p> <table border="1" data-bbox="542 1288 1189 1500"> <thead> <tr> <th>Motor Rotational Direction (Pin No.)</th> <th>VCRUN1 (No.6)</th> <th>VCRUN2 (No.7)</th> </tr> </thead> <tbody> <tr> <td>CCW</td> <td><input checked="" type="checkbox"/> Close</td> <td><input type="checkbox"/> Open</td> </tr> <tr> <td>CW</td> <td><input type="checkbox"/> Open</td> <td><input checked="" type="checkbox"/> Close</td> </tr> <tr> <td>Motor Stop</td> <td><input type="checkbox"/> Open</td> <td><input type="checkbox"/> Open</td> </tr> <tr> <td>Motor Stop</td> <td><input checked="" type="checkbox"/> Close</td> <td><input checked="" type="checkbox"/> Close</td> </tr> </tbody> </table> <p>■ Related Parameters •No.390.0, No.391.0 These are used to set acceleration/deceleration time for Homing. •No.392.0...No.399.0 These parameters are used to set 8 speeds. You can switch between the target speeds with combinations of signals, VCSEL1, VCSEL2, and VCSEL3</p> | Motor Rotational Direction (Pin No.) | VCRUN1 (No.6) | VCRUN2 (No.7) | CCW | <input checked="" type="checkbox"/> Close | <input type="checkbox"/> Open | CW | <input type="checkbox"/> Open | <input checked="" type="checkbox"/> Close | Motor Stop | <input type="checkbox"/> Open | <input type="checkbox"/> Open | Motor Stop | <input checked="" type="checkbox"/> Close | <input checked="" type="checkbox"/> Close | |  | | |
| Motor Rotational Direction (Pin No.) | VCRUN1 (No.6) | VCRUN2 (No.7) | | | | | | | | | | | | | | | | | | | |
| CCW | <input checked="" type="checkbox"/> Close | <input type="checkbox"/> Open | | | | | | | | | | | | | | | | | | | |
| CW | <input type="checkbox"/> Open | <input checked="" type="checkbox"/> Close | | | | | | | | | | | | | | | | | | | |
| Motor Stop | <input type="checkbox"/> Open | <input type="checkbox"/> Open | | | | | | | | | | | | | | | | | | | |
| Motor Stop | <input checked="" type="checkbox"/> Close | <input checked="" type="checkbox"/> Close | | | | | | | | | | | | | | | | | | | |

5. Descriptions of CN1 Connector Signals













| Pin No. | 7 | Interface Circuit | PI (page 45) | Control Mode | | | | | | | | | | | | | | | | | | | | | | | | | | | | | | | | | | | | | | | | | | | | | | | | | | | | | | | | | | | | | | | | | | | | | | | | | | | | | | | | | | | | | | | |
|---|---|---|---|---|---------------|---------------|---------------|----------------|----------|-------------------------------|-------------------------------|-------------------------------|-------------------------------|---|---|-------------------------------|-------------------------------|-------------------------------|---|-------------------------------|---|-------------------------------|-------------------------------|---|---|---|-------------------------------|-------------------------------|---|-------------------------------|-------------------------------|---|-------------------------------|---|---|-------------------------------|---|-------------------------------|---|-------------------------------|---|---|-------------------------------|---|---|---|---|-------------------------------|---|-------------------------------|-------------------------------|-------------------------------|---|---|---|-------------------------------|-------------------------------|---|----|-------------------------------|---|-------------------------------|---|----|---|---|-------------------------------|---|----|-------------------------------|-------------------------------|---|---|----|---|-------------------------------|---|---|----|-------------------------------|---|---|---|----|---|---|---|---|---|--|--|
| Signal | Description | | | P | S | T | | | | | | | | | | | | | | | | | | | | | | | | | | | | | | | | | | | | | | | | | | | | | | | | | | | | | | | | | | | | | | | | | | | | | | | | | | | | | | | | | | | | | |
|  PCLR Position Error Counter Clear | <input checked="" type="checkbox"/> Close Error Counter Clear is executed. ■ TIP Be sure to turn off this signal after Error counter execution. ■ Related Parameters No. 67.3 | | |    | | | | | | | | | | | | | | | | | | | | | | | | | | | | | | | | | | | | | | | | | | | | | | | | | | | | | | | | | | | | | | | | | | | | | | | | | | | | | | | | | | | | | | | |
|  PCSEL1 Point No. Select 1 | <input type="checkbox"/> Open / <input checked="" type="checkbox"/> Close You can specify the Point No. with a combination of PCSEL1...PCSEL4. <table border="1"> <thead> <tr> <th>Point No. (PinNo.)</th> <th>PCSEL1 (No.7)</th> <th>PCSEL2 (No.8)</th> <th>PCSEL3 (No.9)</th> <th>PCSEL4 (No.10)</th> </tr> </thead> <tbody> <tr><td>0 Homing</td><td><input type="checkbox"/> Open</td><td><input type="checkbox"/> Open</td><td><input type="checkbox"/> Open</td><td><input type="checkbox"/> Open</td></tr> <tr><td>1</td><td><input checked="" type="checkbox"/> Close</td><td><input type="checkbox"/> Open</td><td><input type="checkbox"/> Open</td><td><input type="checkbox"/> Open</td></tr> <tr><td>2</td><td><input type="checkbox"/> Open</td><td><input checked="" type="checkbox"/> Close</td><td><input type="checkbox"/> Open</td><td><input type="checkbox"/> Open</td></tr> <tr><td>3</td><td><input checked="" type="checkbox"/> Close</td><td><input checked="" type="checkbox"/> Close</td><td><input type="checkbox"/> Open</td><td><input type="checkbox"/> Open</td></tr> <tr><td>4</td><td><input type="checkbox"/> Open</td><td><input type="checkbox"/> Open</td><td><input checked="" type="checkbox"/> Close</td><td><input type="checkbox"/> Open</td></tr> <tr><td>5</td><td><input checked="" type="checkbox"/> Close</td><td><input type="checkbox"/> Open</td><td><input checked="" type="checkbox"/> Close</td><td><input type="checkbox"/> Open</td></tr> <tr><td>6</td><td><input type="checkbox"/> Open</td><td><input checked="" type="checkbox"/> Close</td><td><input checked="" type="checkbox"/> Close</td><td><input type="checkbox"/> Open</td></tr> <tr><td>7</td><td><input checked="" type="checkbox"/> Close</td><td><input checked="" type="checkbox"/> Close</td><td><input checked="" type="checkbox"/> Close</td><td><input type="checkbox"/> Open</td></tr> <tr><td>8</td><td><input type="checkbox"/> Open</td><td><input type="checkbox"/> Open</td><td><input type="checkbox"/> Open</td><td><input checked="" type="checkbox"/> Close</td></tr> <tr><td>9</td><td><input checked="" type="checkbox"/> Close</td><td><input type="checkbox"/> Open</td><td><input type="checkbox"/> Open</td><td><input checked="" type="checkbox"/> Close</td></tr> <tr><td>10</td><td><input type="checkbox"/> Open</td><td><input checked="" type="checkbox"/> Close</td><td><input type="checkbox"/> Open</td><td><input checked="" type="checkbox"/> Close</td></tr> <tr><td>11</td><td><input checked="" type="checkbox"/> Close</td><td><input checked="" type="checkbox"/> Close</td><td><input type="checkbox"/> Open</td><td><input checked="" type="checkbox"/> Close</td></tr> <tr><td>12</td><td><input type="checkbox"/> Open</td><td><input type="checkbox"/> Open</td><td><input checked="" type="checkbox"/> Close</td><td><input checked="" type="checkbox"/> Close</td></tr> <tr><td>13</td><td><input checked="" type="checkbox"/> Close</td><td><input type="checkbox"/> Open</td><td><input checked="" type="checkbox"/> Close</td><td><input checked="" type="checkbox"/> Close</td></tr> <tr><td>14</td><td><input type="checkbox"/> Open</td><td><input checked="" type="checkbox"/> Close</td><td><input checked="" type="checkbox"/> Close</td><td><input checked="" type="checkbox"/> Close</td></tr> <tr><td>15</td><td><input checked="" type="checkbox"/> Close</td><td><input checked="" type="checkbox"/> Close</td><td><input checked="" type="checkbox"/> Close</td><td><input checked="" type="checkbox"/> Close</td></tr> </tbody> </table> ■ Related Parameters ・No.646.3 This parameter enables you to select motion per Point No.0 from either Homing or Point Table Motion. | | | Point No. (PinNo.) | PCSEL1 (No.7) | PCSEL2 (No.8) | PCSEL3 (No.9) | PCSEL4 (No.10) | 0 Homing | <input type="checkbox"/> Open | <input type="checkbox"/> Open | <input type="checkbox"/> Open | <input type="checkbox"/> Open | 1 | <input checked="" type="checkbox"/> Close | <input type="checkbox"/> Open | <input type="checkbox"/> Open | <input type="checkbox"/> Open | 2 | <input type="checkbox"/> Open | <input checked="" type="checkbox"/> Close | <input type="checkbox"/> Open | <input type="checkbox"/> Open | 3 | <input checked="" type="checkbox"/> Close | <input checked="" type="checkbox"/> Close | <input type="checkbox"/> Open | <input type="checkbox"/> Open | 4 | <input type="checkbox"/> Open | <input type="checkbox"/> Open | <input checked="" type="checkbox"/> Close | <input type="checkbox"/> Open | 5 | <input checked="" type="checkbox"/> Close | <input type="checkbox"/> Open | <input checked="" type="checkbox"/> Close | <input type="checkbox"/> Open | 6 | <input type="checkbox"/> Open | <input checked="" type="checkbox"/> Close | <input checked="" type="checkbox"/> Close | <input type="checkbox"/> Open | 7 | <input checked="" type="checkbox"/> Close | <input checked="" type="checkbox"/> Close | <input checked="" type="checkbox"/> Close | <input type="checkbox"/> Open | 8 | <input type="checkbox"/> Open | <input type="checkbox"/> Open | <input type="checkbox"/> Open | <input checked="" type="checkbox"/> Close | 9 | <input checked="" type="checkbox"/> Close | <input type="checkbox"/> Open | <input type="checkbox"/> Open | <input checked="" type="checkbox"/> Close | 10 | <input type="checkbox"/> Open | <input checked="" type="checkbox"/> Close | <input type="checkbox"/> Open | <input checked="" type="checkbox"/> Close | 11 | <input checked="" type="checkbox"/> Close | <input checked="" type="checkbox"/> Close | <input type="checkbox"/> Open | <input checked="" type="checkbox"/> Close | 12 | <input type="checkbox"/> Open | <input type="checkbox"/> Open | <input checked="" type="checkbox"/> Close | <input checked="" type="checkbox"/> Close | 13 | <input checked="" type="checkbox"/> Close | <input type="checkbox"/> Open | <input checked="" type="checkbox"/> Close | <input checked="" type="checkbox"/> Close | 14 | <input type="checkbox"/> Open | <input checked="" type="checkbox"/> Close | <input checked="" type="checkbox"/> Close | <input checked="" type="checkbox"/> Close | 15 | <input checked="" type="checkbox"/> Close | <input checked="" type="checkbox"/> Close | <input checked="" type="checkbox"/> Close | <input checked="" type="checkbox"/> Close |  | | |
| Point No. (PinNo.) | PCSEL1 (No.7) | PCSEL2 (No.8) | PCSEL3 (No.9) | PCSEL4 (No.10) | | | | | | | | | | | | | | | | | | | | | | | | | | | | | | | | | | | | | | | | | | | | | | | | | | | | | | | | | | | | | | | | | | | | | | | | | | | | | | | | | | | | | | | |
| 0 Homing | <input type="checkbox"/> Open | <input type="checkbox"/> Open | <input type="checkbox"/> Open | <input type="checkbox"/> Open | | | | | | | | | | | | | | | | | | | | | | | | | | | | | | | | | | | | | | | | | | | | | | | | | | | | | | | | | | | | | | | | | | | | | | | | | | | | | | | | | | | | | | | |
| 1 | <input checked="" type="checkbox"/> Close | <input type="checkbox"/> Open | <input type="checkbox"/> Open | <input type="checkbox"/> Open | | | | | | | | | | | | | | | | | | | | | | | | | | | | | | | | | | | | | | | | | | | | | | | | | | | | | | | | | | | | | | | | | | | | | | | | | | | | | | | | | | | | | | | |
| 2 | <input type="checkbox"/> Open | <input checked="" type="checkbox"/> Close | <input type="checkbox"/> Open | <input type="checkbox"/> Open | | | | | | | | | | | | | | | | | | | | | | | | | | | | | | | | | | | | | | | | | | | | | | | | | | | | | | | | | | | | | | | | | | | | | | | | | | | | | | | | | | | | | | | |
| 3 | <input checked="" type="checkbox"/> Close | <input checked="" type="checkbox"/> Close | <input type="checkbox"/> Open | <input type="checkbox"/> Open | | | | | | | | | | | | | | | | | | | | | | | | | | | | | | | | | | | | | | | | | | | | | | | | | | | | | | | | | | | | | | | | | | | | | | | | | | | | | | | | | | | | | | | |
| 4 | <input type="checkbox"/> Open | <input type="checkbox"/> Open | <input checked="" type="checkbox"/> Close | <input type="checkbox"/> Open | | | | | | | | | | | | | | | | | | | | | | | | | | | | | | | | | | | | | | | | | | | | | | | | | | | | | | | | | | | | | | | | | | | | | | | | | | | | | | | | | | | | | | | |
| 5 | <input checked="" type="checkbox"/> Close | <input type="checkbox"/> Open | <input checked="" type="checkbox"/> Close | <input type="checkbox"/> Open | | | | | | | | | | | | | | | | | | | | | | | | | | | | | | | | | | | | | | | | | | | | | | | | | | | | | | | | | | | | | | | | | | | | | | | | | | | | | | | | | | | | | | | |
| 6 | <input type="checkbox"/> Open | <input checked="" type="checkbox"/> Close | <input checked="" type="checkbox"/> Close | <input type="checkbox"/> Open | | | | | | | | | | | | | | | | | | | | | | | | | | | | | | | | | | | | | | | | | | | | | | | | | | | | | | | | | | | | | | | | | | | | | | | | | | | | | | | | | | | | | | | |
| 7 | <input checked="" type="checkbox"/> Close | <input checked="" type="checkbox"/> Close | <input checked="" type="checkbox"/> Close | <input type="checkbox"/> Open | | | | | | | | | | | | | | | | | | | | | | | | | | | | | | | | | | | | | | | | | | | | | | | | | | | | | | | | | | | | | | | | | | | | | | | | | | | | | | | | | | | | | | | |
| 8 | <input type="checkbox"/> Open | <input type="checkbox"/> Open | <input type="checkbox"/> Open | <input checked="" type="checkbox"/> Close | | | | | | | | | | | | | | | | | | | | | | | | | | | | | | | | | | | | | | | | | | | | | | | | | | | | | | | | | | | | | | | | | | | | | | | | | | | | | | | | | | | | | | | |
| 9 | <input checked="" type="checkbox"/> Close | <input type="checkbox"/> Open | <input type="checkbox"/> Open | <input checked="" type="checkbox"/> Close | | | | | | | | | | | | | | | | | | | | | | | | | | | | | | | | | | | | | | | | | | | | | | | | | | | | | | | | | | | | | | | | | | | | | | | | | | | | | | | | | | | | | | | |
| 10 | <input type="checkbox"/> Open | <input checked="" type="checkbox"/> Close | <input type="checkbox"/> Open | <input checked="" type="checkbox"/> Close | | | | | | | | | | | | | | | | | | | | | | | | | | | | | | | | | | | | | | | | | | | | | | | | | | | | | | | | | | | | | | | | | | | | | | | | | | | | | | | | | | | | | | | |
| 11 | <input checked="" type="checkbox"/> Close | <input checked="" type="checkbox"/> Close | <input type="checkbox"/> Open | <input checked="" type="checkbox"/> Close | | | | | | | | | | | | | | | | | | | | | | | | | | | | | | | | | | | | | | | | | | | | | | | | | | | | | | | | | | | | | | | | | | | | | | | | | | | | | | | | | | | | | | | |
| 12 | <input type="checkbox"/> Open | <input type="checkbox"/> Open | <input checked="" type="checkbox"/> Close | <input checked="" type="checkbox"/> Close | | | | | | | | | | | | | | | | | | | | | | | | | | | | | | | | | | | | | | | | | | | | | | | | | | | | | | | | | | | | | | | | | | | | | | | | | | | | | | | | | | | | | | | |
| 13 | <input checked="" type="checkbox"/> Close | <input type="checkbox"/> Open | <input checked="" type="checkbox"/> Close | <input checked="" type="checkbox"/> Close | | | | | | | | | | | | | | | | | | | | | | | | | | | | | | | | | | | | | | | | | | | | | | | | | | | | | | | | | | | | | | | | | | | | | | | | | | | | | | | | | | | | | | | |
| 14 | <input type="checkbox"/> Open | <input checked="" type="checkbox"/> Close | <input checked="" type="checkbox"/> Close | <input checked="" type="checkbox"/> Close | | | | | | | | | | | | | | | | | | | | | | | | | | | | | | | | | | | | | | | | | | | | | | | | | | | | | | | | | | | | | | | | | | | | | | | | | | | | | | | | | | | | | | | |
| 15 | <input checked="" type="checkbox"/> Close | <input checked="" type="checkbox"/> Close | <input checked="" type="checkbox"/> Close | <input checked="" type="checkbox"/> Close | | | | | | | | | | | | | | | | | | | | | | | | | | | | | | | | | | | | | | | | | | | | | | | | | | | | | | | | | | | | | | | | | | | | | | | | | | | | | | | | | | | | | | | |
|  VCRUN2 Internal Velocity Start 2 | <input checked="" type="checkbox"/> Close Motor rotates in CW direction  VCRUN1 (Pin No.6) | | |  | | | | | | | | | | | | | | | | | | | | | | | | | | | | | | | | | | | | | | | | | | | | | | | | | | | | | | | | | | | | | | | | | | | | | | | | | | | | | | | | | | | | | | | |

5. Descriptions of CN1 Connector Signals













| Pin No. | 8 | Interface Circuit | PI (page 45) | Control Mode | | | | | | | | | | | | | | | | | | | | | | | | | | | | | | | | | | | | | | |
|--|--|---|---|---|---------------|---------------|---------------|---|-------------------------------------|-------------------------------------|-------------------------------------|---|---|-------------------------------------|-------------------------------------|---|---|---|-------------------------------------|---|---|---|-------------------------------------|---|-------------------------------------|-------------------------------------|---|---|---|-------------------------------------|---|---|-------------------------------------|---|---|---|---|---|---|---|--|--|
| Signal | Description | | | P | S | T | | | | | | | | | | | | | | | | | | | | | | | | | | | | | | | | | | | | |
|  PCSEL2 Point No. Select 2 | <input type="button" value="Open"/> / <input checked="" type="button" value="Close"/> You can specify the Point No. with a combination of PCSEL1...PCSEL4.  PCSEL1 (Pin No.7) | | |  | | | | | | | | | | | | | | | | | | | | | | | | | | | | | | | | | | | | | | |
|  VCSEL1 Speed Select 1 | <input type="button" value="Open"/> / <input checked="" type="button" value="Close"/> You can select the target speed pin number with a combination of VCSEL1...VCSEL3. <table border="1" data-bbox="550 900 1114 1258"> <thead> <tr> <th>Target speed (Pin No.)</th> <th>PCSEL1 (No.7)</th> <th>PCSEL2 (No.8)</th> <th>PCSEL3 (No.9)</th> </tr> </thead> <tbody> <tr> <td>0</td> <td><input type="button" value="Open"/></td> <td><input type="button" value="Open"/></td> <td><input type="button" value="Open"/></td> </tr> <tr> <td>1</td> <td><input checked="" type="button" value="Close"/></td> <td><input type="button" value="Open"/></td> <td><input type="button" value="Open"/></td> </tr> <tr> <td>2</td> <td><input checked="" type="button" value="Close"/></td> <td><input checked="" type="button" value="Close"/></td> <td><input type="button" value="Open"/></td> </tr> <tr> <td>3</td> <td><input checked="" type="button" value="Close"/></td> <td><input checked="" type="button" value="Close"/></td> <td><input type="button" value="Open"/></td> </tr> <tr> <td>4</td> <td><input type="button" value="Open"/></td> <td><input type="button" value="Open"/></td> <td><input checked="" type="button" value="Close"/></td> </tr> <tr> <td>5</td> <td><input checked="" type="button" value="Close"/></td> <td><input type="button" value="Open"/></td> <td><input checked="" type="button" value="Close"/></td> </tr> <tr> <td>6</td> <td><input type="button" value="Open"/></td> <td><input checked="" type="button" value="Close"/></td> <td><input checked="" type="button" value="Close"/></td> </tr> <tr> <td>7</td> <td><input checked="" type="button" value="Close"/></td> <td><input checked="" type="button" value="Close"/></td> <td><input checked="" type="button" value="Close"/></td> </tr> </tbody> </table>  VCRUN1 (Pin No.6) | | | Target speed (Pin No.) | PCSEL1 (No.7) | PCSEL2 (No.8) | PCSEL3 (No.9) | 0 | <input type="button" value="Open"/> | <input type="button" value="Open"/> | <input type="button" value="Open"/> | 1 | <input checked="" type="button" value="Close"/> | <input type="button" value="Open"/> | <input type="button" value="Open"/> | 2 | <input checked="" type="button" value="Close"/> | <input checked="" type="button" value="Close"/> | <input type="button" value="Open"/> | 3 | <input checked="" type="button" value="Close"/> | <input checked="" type="button" value="Close"/> | <input type="button" value="Open"/> | 4 | <input type="button" value="Open"/> | <input type="button" value="Open"/> | <input checked="" type="button" value="Close"/> | 5 | <input checked="" type="button" value="Close"/> | <input type="button" value="Open"/> | <input checked="" type="button" value="Close"/> | 6 | <input type="button" value="Open"/> | <input checked="" type="button" value="Close"/> | <input checked="" type="button" value="Close"/> | 7 | <input checked="" type="button" value="Close"/> | <input checked="" type="button" value="Close"/> | <input checked="" type="button" value="Close"/> |  | | |
| Target speed (Pin No.) | PCSEL1 (No.7) | PCSEL2 (No.8) | PCSEL3 (No.9) | | | | | | | | | | | | | | | | | | | | | | | | | | | | | | | | | | | | | | | |
| 0 | <input type="button" value="Open"/> | <input type="button" value="Open"/> | <input type="button" value="Open"/> | | | | | | | | | | | | | | | | | | | | | | | | | | | | | | | | | | | | | | | |
| 1 | <input checked="" type="button" value="Close"/> | <input type="button" value="Open"/> | <input type="button" value="Open"/> | | | | | | | | | | | | | | | | | | | | | | | | | | | | | | | | | | | | | | | |
| 2 | <input checked="" type="button" value="Close"/> | <input checked="" type="button" value="Close"/> | <input type="button" value="Open"/> | | | | | | | | | | | | | | | | | | | | | | | | | | | | | | | | | | | | | | | |
| 3 | <input checked="" type="button" value="Close"/> | <input checked="" type="button" value="Close"/> | <input type="button" value="Open"/> | | | | | | | | | | | | | | | | | | | | | | | | | | | | | | | | | | | | | | | |
| 4 | <input type="button" value="Open"/> | <input type="button" value="Open"/> | <input checked="" type="button" value="Close"/> | | | | | | | | | | | | | | | | | | | | | | | | | | | | | | | | | | | | | | | |
| 5 | <input checked="" type="button" value="Close"/> | <input type="button" value="Open"/> | <input checked="" type="button" value="Close"/> | | | | | | | | | | | | | | | | | | | | | | | | | | | | | | | | | | | | | | | |
| 6 | <input type="button" value="Open"/> | <input checked="" type="button" value="Close"/> | <input checked="" type="button" value="Close"/> | | | | | | | | | | | | | | | | | | | | | | | | | | | | | | | | | | | | | | | |
| 7 | <input checked="" type="button" value="Close"/> | <input checked="" type="button" value="Close"/> | <input checked="" type="button" value="Close"/> | | | | | | | | | | | | | | | | | | | | | | | | | | | | | | | | | | | | | | | |
|  HOME Start Homing | <input checked="" type="button" value="Close"/> Homing starts. ■ TIP Be sure to set this terminal to Open after homing is completed. | | |  * | | | | | | | | | | | | | | | | | | | | | | | | | | | | | | | | | | | | | | |
|  E-STOP Emergency Stop | <input type="button" value="Open"/> The motor makes an emergency stop. Deceleration stop starts upon Servo OFF and the motor stops its motion. No alarm occurs. A warning is output by parameter setting.  9 Appendix Functions | | |  ** | | | | | | | | | | | | | | | | | | | | | | | | | | | | | | | | | | | | | | |

* In I/O configuration Option 1
 ** In I/O configuration Option 2

5. Descriptions of CN1 Connector Signals











| Pin No. | 9 | Interface Circuit | PI (page 45) | Control Mode | | |
|---|---|---|---|---|---|---|
| Signal | Description | | | P | S | T |
| CCWL CCW drive limit switch input |  <input type="checkbox"/> Open Prohibits CCW motion. <input checked="" type="checkbox"/> Close Allows CCW motion. ■ TIP Make the connection such that COM- becomes open when the equipment moves beyond the CCW motion range. ■ Related Parameters ·No.67.0 Restriction enabled when “2: Enable CCW drive limit switch” or “3: Enable CW/CCW drive limit switch” is selected. ·No.67.1 Enables you to specify the deceleration method. The initial setting is 1 (short brake). ·No.67.2 Enables you to specify the status after the motor stops. The initial setting is 0 (coast to stop). ·No.67.3 You can select keep or clear the position error counter data. The initial setting is “0: keep” . |    |  |  | | |
| PCSEL3 Point No. Select 3 |  <input type="checkbox"/> Open / <input checked="" type="checkbox"/> Close You can specify the Point No. with a combination of PCSEL1...PCSEL4.  PCSEL1 (Pin No.7) |  | | | | |
| VCSEL2 Speed Select 2 |  <input type="checkbox"/> Open / <input checked="" type="checkbox"/> Close You can select the target speed setting with a combination of VCSEL1...VCSEL3.  VCSEL1 (Pin No.8) |  | | | | |

5. Descriptions of CN1 Connector Signals

| Pin No. | Signal | Interface Circuit | PI (page 45) | Control Mode | | |
|---------|--|--|--|---|---|---|
| | | | | P | S | T |
| 10 |  CWL CW Drive limit switch input | <input type="button" value="Open"/> Prohibits CW motion. <input type="button" value="Close"/> Allows CW motion. |    CCWL (Pin No.9) |  |  | |
| |  PCSEL4 Point No. Select 4 | <input type="button" value="Open"/> / <input type="button" value="Close"/> You can specify the Point No. with a combination of PCSEL1...PCSEL4. |  * PCSEL1 (Pin No.7) | | | |
| |  HOME Start Homing | <input type="button" value="Close"/> Homing starts. ■ TIP Be sure to turn off this signal after homing is completed. |  ** | | | |
| |  VCSEL3 Speed Select 3 | <input type="button" value="Open"/> / <input type="button" value="Close"/> You can select the target speed setting with a combination of VCSEL1...VCSEL3. |  VCRUN1 (Pin No.8) |  | | |

* In Standard I/O configuration
 ** In Optional I/O configuration.

5. Descriptions of CN1 Connector Signals

| Pin No. | 11 | Interface Circuit | PI (page 45) | Control Mode | | |
|-------------------------------|---|---|--|--|---|---|
| Signal | Description | | | P | S | T |
| TLSEL1 Torque Limit |  | <input type="button" value="Open"/> Torque command limit: Value 1 (No.147.0) is applied. <input type="button" value="Close"/> Torque command limit: Value 2 (No.148.0) is applied. ■ Related Parameters ・No.144.0 Torque Limit is enabled when 1 (enable) is selected. ・No.147.0, No.148.0 Set Torque Command Limit Values 1 and 2. |     ** |   |  | |
| ORG Home Sensor |  | <input type="button" value="Open"/> Home sensor has not been detected. <input type="button" value="Close"/> Home sensor has been detected. ■ Related Parameters ・No.645.0 Enables you to select home-sensor-front. ・No.646.1 Enables you to change the polarity of home sensor detection. |  * | | | |

* In Standard I/O configuration









** In Optional I/O configuration.

5. Descriptions of CN1 Connector Signals

General-Purpose Output











| Pin No. | 12 | Interface Circuit | PS (page 45) | Control Mode | | | | | | | | | | | | | | | | | | | | | | | | | | | | | | | | | | | | | | |
|-----------------------------|---|--|---|---------------|---------------|---------------|------------|-------------------------------------|-------------------------------------|-------------------------------------|------|---|-------------------------------------|-------------------------------------|-------|-------------------------------------|---|-------------------------------------|-------|---|---|-------------------------------------|-------|-------------------------------------|-------------------------------------|---|-------|---|-------------------------------------|---|-------|-------------------------------------|---|---|-------|---|---|---|--|--|--|--|
| Signal | Description | | P | S | T | | | | | | | | | | | | | | | | | | | | | | | | | | | | | | | | | | | | | |
| COM – I/O power GND | <p>A common emitter terminal of output transistors in the general-purpose output circuit. COM+ and G24V drive control power must share one common power supply.</p> | | | | | | | | | | | | | | | | | | | | | | | | | | | | | | | | | | | | | | | | | |
| Pin No. | 13 | Interface Circuit | PO (Page 46) | Control Mode | | | | | | | | | | | | | | | | | | | | | | | | | | | | | | | | | | | | | | |
| Signal | Description | | P | S | T | | | | | | | | | | | | | | | | | | | | | | | | | | | | | | | | | | | | | |
| MBRK Motor Brake Release | | <p><input type="button" value="Open"/></p> <p>Does not release the brake.</p> <p><input checked="" type="button" value="Close"/></p> <p>Releases the brake.</p> <p>■ TIP The motor brake cannot be driven directly. To drive the motor brake, be sure to use a relay.</p> <p>Place a surge absorber to suppress surge voltage caused by relay's on/off. Note that, if you use a diode instead of a surge absorber, the time between brake release and brake clamp is longer.</p> | | | | | | | | | | | | | | | | | | | | | | | | | | | | | | | | | | | | | | | | |
| PM1 Point No.1 | | <p><input type="button" value="Open"/> / <input checked="" type="button" value="Close"/></p> <p>Outputs the started or completed Point No. with a combination of PM1... PM3.</p> <p>Right after turning the power on for the drive or at Servo OFF or Homing, all three are Open (i.e. Point No. = 0).</p> <table border="1"> <thead> <tr> <th>Point No. (Pin No.)</th> <th>PM1 (No.7)</th> <th>PM2 (No.8)</th> <th>PM3 (No.9)</th> </tr> </thead> <tbody> <tr> <td>0, 8, etc.</td> <td><input type="button" value="Open"/></td> <td><input type="button" value="Open"/></td> <td><input type="button" value="Open"/></td> </tr> <tr> <td>1, 9</td> <td><input checked="" type="button" value="Close"/></td> <td><input type="button" value="Open"/></td> <td><input type="button" value="Open"/></td> </tr> <tr> <td>2, 10</td> <td><input type="button" value="Open"/></td> <td><input checked="" type="button" value="Close"/></td> <td><input type="button" value="Open"/></td> </tr> <tr> <td>3, 11</td> <td><input checked="" type="button" value="Close"/></td> <td><input checked="" type="button" value="Close"/></td> <td><input type="button" value="Open"/></td> </tr> <tr> <td>4, 12</td> <td><input type="button" value="Open"/></td> <td><input type="button" value="Open"/></td> <td><input checked="" type="button" value="Close"/></td> </tr> <tr> <td>5, 13</td> <td><input checked="" type="button" value="Close"/></td> <td><input type="button" value="Open"/></td> <td><input checked="" type="button" value="Close"/></td> </tr> <tr> <td>6, 14</td> <td><input type="button" value="Open"/></td> <td><input checked="" type="button" value="Close"/></td> <td><input checked="" type="button" value="Close"/></td> </tr> <tr> <td>7, 15</td> <td><input checked="" type="button" value="Close"/></td> <td><input checked="" type="button" value="Close"/></td> <td><input checked="" type="button" value="Close"/></td> </tr> </tbody> </table> <p>■ Related Parameters ·No.644.0 Enables you to select timing of Point No. output and its content.</p> | Point No. (Pin No.) | PM1 (No.7) | PM2 (No.8) | PM3 (No.9) | 0, 8, etc. | <input type="button" value="Open"/> | <input type="button" value="Open"/> | <input type="button" value="Open"/> | 1, 9 | <input checked="" type="button" value="Close"/> | <input type="button" value="Open"/> | <input type="button" value="Open"/> | 2, 10 | <input type="button" value="Open"/> | <input checked="" type="button" value="Close"/> | <input type="button" value="Open"/> | 3, 11 | <input checked="" type="button" value="Close"/> | <input checked="" type="button" value="Close"/> | <input type="button" value="Open"/> | 4, 12 | <input type="button" value="Open"/> | <input type="button" value="Open"/> | <input checked="" type="button" value="Close"/> | 5, 13 | <input checked="" type="button" value="Close"/> | <input type="button" value="Open"/> | <input checked="" type="button" value="Close"/> | 6, 14 | <input type="button" value="Open"/> | <input checked="" type="button" value="Close"/> | <input checked="" type="button" value="Close"/> | 7, 15 | <input checked="" type="button" value="Close"/> | <input checked="" type="button" value="Close"/> | <input checked="" type="button" value="Close"/> | | | | |
| Point No. (Pin No.) | PM1 (No.7) | PM2 (No.8) | PM3 (No.9) | | | | | | | | | | | | | | | | | | | | | | | | | | | | | | | | | | | | | | | |
| 0, 8, etc. | <input type="button" value="Open"/> | <input type="button" value="Open"/> | <input type="button" value="Open"/> | | | | | | | | | | | | | | | | | | | | | | | | | | | | | | | | | | | | | | | |
| 1, 9 | <input checked="" type="button" value="Close"/> | <input type="button" value="Open"/> | <input type="button" value="Open"/> | | | | | | | | | | | | | | | | | | | | | | | | | | | | | | | | | | | | | | | |
| 2, 10 | <input type="button" value="Open"/> | <input checked="" type="button" value="Close"/> | <input type="button" value="Open"/> | | | | | | | | | | | | | | | | | | | | | | | | | | | | | | | | | | | | | | | |
| 3, 11 | <input checked="" type="button" value="Close"/> | <input checked="" type="button" value="Close"/> | <input type="button" value="Open"/> | | | | | | | | | | | | | | | | | | | | | | | | | | | | | | | | | | | | | | | |
| 4, 12 | <input type="button" value="Open"/> | <input type="button" value="Open"/> | <input checked="" type="button" value="Close"/> | | | | | | | | | | | | | | | | | | | | | | | | | | | | | | | | | | | | | | | |
| 5, 13 | <input checked="" type="button" value="Close"/> | <input type="button" value="Open"/> | <input checked="" type="button" value="Close"/> | | | | | | | | | | | | | | | | | | | | | | | | | | | | | | | | | | | | | | | |
| 6, 14 | <input type="button" value="Open"/> | <input checked="" type="button" value="Close"/> | <input checked="" type="button" value="Close"/> | | | | | | | | | | | | | | | | | | | | | | | | | | | | | | | | | | | | | | | |
| 7, 15 | <input checked="" type="button" value="Close"/> | <input checked="" type="button" value="Close"/> | <input checked="" type="button" value="Close"/> | | | | | | | | | | | | | | | | | | | | | | | | | | | | | | | | | | | | | | | |

5. Descriptions of CN1 Connector Signals

| Pin No. | 14 | Interface Circuit | PO (Page 46) | Control Mode | | |
|---|---|-------------------|--------------|--|---|---|
| Signal | Description | | | P | S | T |
|  SERVO Servo Status | <input type="button" value="Open"/> Servo-Off <input type="button" value="Close"/> Servo-On | | |  24  I/O * |  I/O  | |
| | | | |  ** | | |
|  PM2 Point No.2 | <input type="button" value="Open"/> / <input type="button" value="Close"/> Outputs the started or completed Point No. with a combination of PM1... PM3.  PM1 (Pin No.13) | | |  ** | | |

*1) In Standard I/O configuration









*2) In Optional I/O configuration.

| Pin No. | 15 | Interface Circuit | PO (Page 46) | Control Mode | | |
|---|--|-------------------|--------------|--|---|---|
| Signal | Description | | | P | S | T |
|  POSIN Positioning Complete | <input type="button" value="Open"/> Positioning is not complete. <input type="button" value="Close"/> Positioning is complete. | | |  24  | | |
| | | | |  * | | |
|  MEND Motion Complete | <input type="button" value="Open"/> Motor motion is not complete. <input type="button" value="Close"/> • Ready to receive next motion directive after Point table motion and Testing motion complete. • In Servo-Off state | | |  ** | | |
| | | | |  ** | | |
|  PM3 Point No.3 | <input type="button" value="Open"/> / <input type="button" value="Close"/> Outputs the started or completed Point No. with a combination of PM1... PM3.  PM1 (Pin No.13) | | |  ** | | |

* In Standard I/O configuration.

** In Optional I/O configuration.















5. Descriptions of CN1 Connector Signals

| Pin No. | Signal | Interface Circuit | PO (Page 46) | Control Mode | | |
|---------|---|---|---|--------------|---|---|
| | | | | P | S | T |
| 16 |  HEND Homing Complete | <p>Open</p> <ul style="list-style-type: none"> · State of Home Lost · During Homing <p>Close</p> <p>State of Homing Complete</p> |  *  *  * | | | |
| |  WARN1 Warning | <p>Open</p> <p>No warning</p> <p>Close</p> <p>A warning state is present</p> <p> 9 Appendix Warning Output</p> |  **  **  ** | | | |

* In Standard I/O configuration









** In Optional I/O configuration.

5. Descriptions of CN1 Connector Signals













| Pin No. | 17 | Interface Circuit | PO (Page 46) | Control Mode | | |
|---|---|-------------------|--------------|--|---|---|
| Signal | Description | | | P | S | T |
|  T-LIMIT Torque Limiting | <p>Close</p> <p>Motor output torque is limited.</p> <p>■ Related Parameters •No.144.1 Enables you to select conditions for torque limit.</p> | | | DIF.  24  5  I/O  * | VOLT  I/O  | VOLT  |
|  MEND/T-LIMIT Motion Complete /Torque Limiting | <p>Close</p> <p>State of one of the following: •MEND Motion Complete •Torque Limiting</p> <p> MEND (Pin No.15)</p> <p>■ Related Parameters •No.144.1 Enables you to select conditions for torque limiting.</p> <p>■ TIP Use this signal as T-LIMIT during press motion. Otherwise, use it as MEND. For T-LIMIT, turn TLSEL1 (Torque Limit) ON. For MEND, turn TLSEL1 (Torque Limit) OFF.</p> | | | DIF.  ** 24  *** 5  *** I/O  *** | | |

- * In Standard I/O configuration
- ** In Optional I/O configuration
- *** In I/O configuration Option 1

5. Descriptions of CN1 Connector Signals

| Pin No. | Signal | Interface Circuit | PO (Page 46) | Control Mode | | |
|---------|------------------------|---|--|--|---|---|
| | | | | P | S | T |
| 18 | OCZ Encoder Z-Phase |  <div style="background-color: black; color: white; padding: 2px; display: inline-block;">Close</div> Open collector output of Encoder Z-phase ■ TIP Z-phase pulse is synchronized with A-phase pulse and is output with the same width as A-phase pulse. Open-collector output ■ Related Parameters ・No.276.0, No.278.0 If Z-phase pulse width is too small to be measured accurately by the host controller, decrease frequency division ratio or rotational speed to increase the pulse width. Pulse width [ms] = 2 / rotational speed [rpm] / (division ratio × 217) × 60 × 1,000. |     |   |  | |

5. Descriptions of CN1 Connector Signals

| Pin No. | 19, 20 | Interface Circuit | PO (Page 46) | Control Mode | | |
|---------|---|--------------------------------|---|--|---|---|
| | Signal | Description | | P | S | T |
| |  | <input type="checkbox"/> Open | | | | |
| | SREDY + (Pin No.19) | | In one of the following conditions An alarm is occurring. The AC supply is not supplied to the drive. |  * | | |
| | SREDY - (Pin No.20) | <input type="checkbox"/> Close | |  |  | |
| | Servo ready | | The following conditions are met at the same time. No alarm is occurring. The AC Supply is supplied to the drive. |  |  |  |
| | | | ■ TIP The emitter side of the output transistor is independent of COM-. Cascade connection to multiple drives is possible. |  ** | | |
| |  | <input type="checkbox"/> Open | | | | |
| | SERVO + (Pin No.19) | | Servo-off status | | | |
| | SERVO - (Pin No.20) | <input type="checkbox"/> Close | |  *** | | |
| | Servo status | | ■ TIP The emitter side of the output transistor is independent of COM-. Cascade connection to multiple drives is possible. | | | |
| | DBRK + (Pin No.19) | <input type="checkbox"/> Open | |  **** | | |
| | DBRK - (Pin No.20) | <input type="checkbox"/> Close | |  **** | | |
| | Emergency stop brake release | | See preparation chapter to build an emergency stop breaking circuit. |  **** | | |









* 1) In Standard I/O configuration

** 2) In Standard I/O configuration

*** 3) In Optional I/O configuration





**** 4) In I/O configuration Option 2

5. Descriptions of CN1 Connector Signals



| Pin No. | 21, 22 | Interface Circuit | PO (Page 46) | Control Mode | | |
|---------|---|---|--------------|---|---|---|
| | | | | P | S | T |
| | Signal | Description | | | | |
| |  | <input type="checkbox"/> Open | | | | |
| | ALM + (Pin No.21) | In one of the following conditions An alarm is occurring. Control power is not supplied to the drive. | |  | | |
| | ALM - (Pin No.22) | <input type="checkbox"/> Close | |  |  | |
| | Alarm | The following conditions are met at the same time. No alarm is occurring. Control power is supplied to the drive. | |  |  |  |
| | | ■ TIP The emitter side of the output transistor is independent of COM-. Cascade connection to multiple drives is possible. | |  | | |

5. Descriptions of CN1 Connector Signals



Command Input



| Pin No. | 26 | Interface Circuit | CP (page 47) | Control Mode | | | | | | | | | | | | | | |
|---|--|-------------------|--------------|---|---------------------|--------------|---|---------------------|--------|---|--------------------------------|----------|---|------------|------|---|--|--|
| Signal | Description | | | P | S | T | | | | | | | | | | | | |
| CMD_PLS Pulse A-phase CCW | Command signal input from the host controller to the drive. Select command pulse train command signal to input. (No.32.0) <table border="1"> <thead> <tr> <th>Parameter No.32.0</th> <th>Command Signal Form</th> <th>Input Signal</th> </tr> </thead> <tbody> <tr> <td>0</td> <td>Pulse and Direction</td> <td>Pulse</td> </tr> <tr> <td>1</td> <td>QEP (Quadrature Encoder Pulse)</td> <td>A-phase</td> </tr> <tr> <td>2</td> <td>CCW and CW</td> <td>CCW</td> </tr> </tbody> </table> <p>■ Related Parameters ·No.2.0, No.3.0, No,32.0</p> | | | Parameter No.32.0 | Command Signal Form | Input Signal | 0 | Pulse and Direction | Pulse | 1 | QEP (Quadrature Encoder Pulse) | A-phase | 2 | CCW and CW | CCW |  | | |
| Parameter No.32.0 | Command Signal Form | Input Signal | | | | | | | | | | | | | | | | |
| 0 | Pulse and Direction | Pulse | | | | | | | | | | | | | | | | |
| 1 | QEP (Quadrature Encoder Pulse) | A-phase | | | | | | | | | | | | | | | | |
| 2 | CCW and CW | CCW | | | | | | | | | | | | | | | | |
| /CMD_PLS /Pulse /A-phase /CCW | Command signal input from the host controller to the drive. Select command pulse train command signal to input. (No.32.0) <table border="1"> <thead> <tr> <th>Parameter No.32.0</th> <th>Command Signal Form</th> <th>Input Signal</th> </tr> </thead> <tbody> <tr> <td>0</td> <td>Pulse and Direction</td> <td>/Pulse</td> </tr> <tr> <td>1</td> <td>QEP (Quadrature Encoder Pulse)</td> <td>/A-phase</td> </tr> <tr> <td>2</td> <td>CCW and CW</td> <td>/CCW</td> </tr> </tbody> </table> <p>■ Related Parameters ·No.2.0, No.3.0, No,32.0</p> | | | Parameter No.32.0 | Command Signal Form | Input Signal | 0 | Pulse and Direction | /Pulse | 1 | QEP (Quadrature Encoder Pulse) | /A-phase | 2 | CCW and CW | /CCW |    | | |
| Parameter No.32.0 | Command Signal Form | Input Signal | | | | | | | | | | | | | | | | |
| 0 | Pulse and Direction | /Pulse | | | | | | | | | | | | | | | | |
| 1 | QEP (Quadrature Encoder Pulse) | /A-phase | | | | | | | | | | | | | | | | |
| 2 | CCW and CW | /CCW | | | | | | | | | | | | | | | | |
| CC-P (Pin No.28) | Command signal input from the host controller to the drive. A power input terminal of 24V open collector. | | | | | | | | | | | | | | | | | |
| CC-D (Pin No.29) | CC-P: Use this in combination with /CMD_PLS. CC-D: Use this in combination with /CMD_DIR. | | |  | | | | | | | | | | | | | | |
| 24V open collector power | | | | | | | | | | | | | | | | | | |

5. Descriptions of CN1 Connector Signals

| Pin No. | 30 | Interface Circuit | CP (page 47) | Control Mode | | | | | | | | | | | | | | |
|--|--|-------------------|--------------|---|---------------------|--------------|---|---------------------|------------|---|--------------------------------|----------|---|------------|-----|---|--|--|
| Signal | Description | | | P | S | T | | | | | | | | | | | | |
| CMD_DIR Direction B-phase CW | Command signal input from the host controller to the drive. Select command pulse train command signal to input. (No.32.0) <table border="1"> <thead> <tr> <th>Parameter No.32.0</th> <th>Command Signal Form</th> <th>Input Signal</th> </tr> </thead> <tbody> <tr> <td>0</td> <td>Pulse and Direction</td> <td>Direction</td> </tr> <tr> <td>1</td> <td>QEP (Quadrature Encoder Pulse)</td> <td>B-phase</td> </tr> <tr> <td>2</td> <td>CCW and CW</td> <td>CW</td> </tr> </tbody> </table> <p>■ Related Parameters ・No.2.0, No.3.0, No.32.0</p> | | | Parameter No.32.0 | Command Signal Form | Input Signal | 0 | Pulse and Direction | Direction | 1 | QEP (Quadrature Encoder Pulse) | B-phase | 2 | CCW and CW | CW |  | | |
| Parameter No.32.0 | Command Signal Form | Input Signal | | | | | | | | | | | | | | | | |
| 0 | Pulse and Direction | Direction | | | | | | | | | | | | | | | | |
| 1 | QEP (Quadrature Encoder Pulse) | B-phase | | | | | | | | | | | | | | | | |
| 2 | CCW and CW | CW | | | | | | | | | | | | | | | | |
| /CMD_DIR /Direction /B-phase /CW | Command signal input from the host controller to the drive. Select command pulse train command signal to input. (No.32.0) <table border="1"> <thead> <tr> <th>Parameter No.32.0</th> <th>Command Signal Form</th> <th>Input Signal</th> </tr> </thead> <tbody> <tr> <td>0</td> <td>Pulse and Direction</td> <td>/Direction</td> </tr> <tr> <td>1</td> <td>QEP(Quadrature Encoder Pulse)</td> <td>/B-phase</td> </tr> <tr> <td>2</td> <td>CCW and CW</td> <td>/CW</td> </tr> </tbody> </table> <p>■ Related Parameters ・No.2.0, No.3.0, No.32.0</p> | | | Parameter No.32.0 | Command Signal Form | Input Signal | 0 | Pulse and Direction | /Direction | 1 | QEP(Quadrature Encoder Pulse) | /B-phase | 2 | CCW and CW | /CW |  | | |
| Parameter No.32.0 | Command Signal Form | Input Signal | | | | | | | | | | | | | | | | |
| 0 | Pulse and Direction | /Direction | | | | | | | | | | | | | | | | |
| 1 | QEP(Quadrature Encoder Pulse) | /B-phase | | | | | | | | | | | | | | | | |
| 2 | CCW and CW | /CW | | | | | | | | | | | | | | | | |
| CC_P-5V (Pin No.49) | Command signal input from the host controller to the drive. A power input terminal of 5V open collector. | | | | | | | | | | | | | | | | | |
| CC_D-5V (Pin No.50) | CC-P-5V: Use this in combination with /CMD_PLS CC-D-5V: Use this in combination with /CMD_DIR. | | |  | | | | | | | | | | | | | | |
| 5V Open collector power | | | | | | | | | | | | | | | | | | |







5. Descriptions of CN1 Connector Signals

| Pin No. | 32 | Interface Circuit | CA (page 48) | Control Mode | | |
|---|---|-------------------|--------------|--------------|---|---|
| Signal | Description | | | P | S | T |
| A_SPEED Analog Velocity Command | Speed command input with analog voltages (-10V to +10V). A_GND (Pin No.33) is the reference point of electric potential. | | | |  | |
| A_TRQ Analog Torque Command | Torque command input with analog voltages (-10V to +10V). A_GND (Pin No.33) is the reference point of electric potential. | | | | |  |

| Pin No. | 33 | Interface Circuit | CA (page 48) | Control Mode | | |
|---------------------------------------|--|-------------------|--------------|--------------|--|--|
| Signal | Description | | | P | S | T |
| A_GND Analog Command Ground | <p>This is the reference point of electric potential for Analog command voltage input to Pin No.32.</p> <p>■ TIP If the analog velocity command circuit of the host controller is isolated from 24V control power supply, connect A_GND to signal ground of the host controller, not to GND of control power. If the analog velocity command circuit is not isolated, connect A_GND to GND of control power.</p> | | | |  |  |





5. Descriptions of CN1 Connector Signals

Encoder Output

| Pin No. | Signal | Interface Circuit | EO (page 49) | Control Mode | | |
|---------|---|---|--|--|---|---|
| | | | | P | S | T |
| | OUT_A (Pin No.36) /OUT_A (Pin No.37) A-phase output | OUT_A, /OUT_A: OUT_B, /OUT_B: OUT_Z, /OUT_Z: SG: Signal ground of the communication IC in the output circuit. This signal is connected to signal ground inside the drive. It is isolated from control power (G24V, COM-). Make the connection to signal ground of the communication IC of the host controller. ■ Related Parameters • No.276.0 No.278.0 |     |   |  | |
| | OUT_B (Pin No.38) /OUT_B (Pin No.39) B-phase output | | | | | |
| | OUT_Z (Pin No.40) /OUT_Z (Pin No.41) Z-phase output | | | | | |
| | SG (Pin No.42) Signal ground | | | | | |

5. Descriptions of CN1 Connector Signals

RS-485 Communication

| Pin No. | 43, 44, 45 Signal | Interface Circuit | RS (page 50) | Control Mode | | | | |
|--|----------------------|--|---|---|---|---|---|---|
| | | | | P | S | T | | |
| 485 (Pin No.43) 485 data | | 485, /485: RS-485 interface with the host controller For cascade connection, be sure to connect a termination resistor of approximately 220 Ω to the end drive. |  24  |  | | | | |
| /485 (Pin No.44) /485 data | | | | | | |  |  |
| SG (Pin No.45) Signal ground | | | | | | | | |
| | | SG: Signal ground of the drive communication IC. It is connected to signal ground inside the drive. Isolated from control power (G24V, COM-). Connect signal ground of the communication IC of the host controller. | | | | | | |

5. Descriptions of CN1 Connector Signals

2. Interface Circuit of CN1 Connector

Interface Circuit

PS Connection to DC24V Power Supply

Connect control power of the drive and I/O power.
 Be careful not to reversely connect plus and minus terminals of the power supply.
 Accidental reverse connection may damage the drive.

Control power and I/O power must share one common power supply.

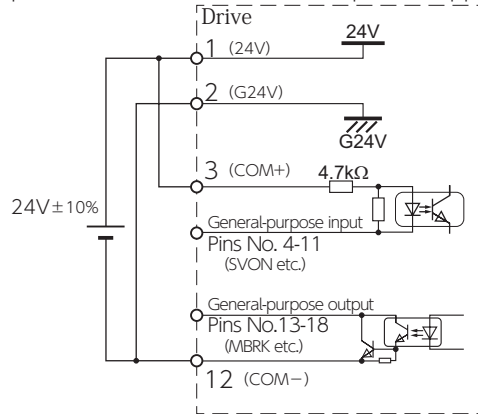

| Control Mode | Control Mode | | |
|--------------|--------------|------|------|
| | P | S | T |
| DIF. | | | |
| 24 | | VOLT | |
| 5 | | I/O | |
| I/O | | | VOLT |

PI Connections to General-Purpose Input Signal

Pin No.3
 Connect to +terminal of I/O power supply. Use power supply of 24V ± 10%.

Pin No.4 to No.11
 Connect to input devices such as switch, open-collector output transistor, and relay contact.
 When the input device contact is closed and the contact pair of general-purpose pin and power supply GND becomes closed, the drive turns on.

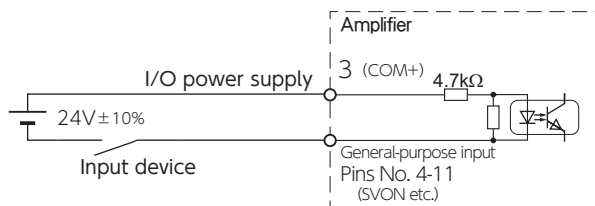

| Control Mode | Control Mode | | |
|--------------|--------------|------|------|
| | P | S | T |
| DIF. | | | |
| 24 | | VOLT | |
| 5 | | I/O | |
| I/O | | | VOLT |

5. Descriptions of CN1 Connector Signals

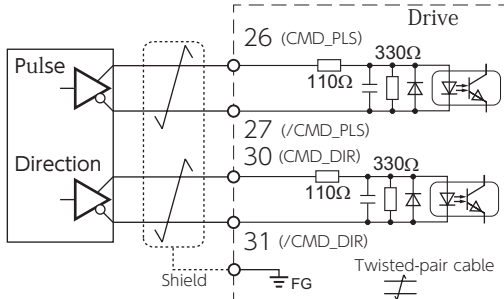
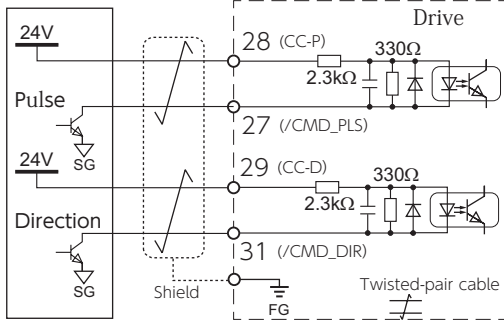
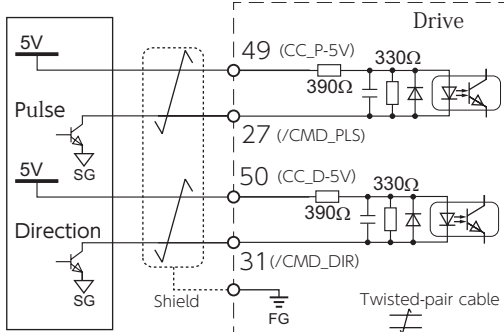

| PO | Connections to General-Purpose Output Signal | Control Mode | | |
|----|---|--------------|---|---|
| | | P | S | T |
| | <p>The motor brake cannot be driven directly. To drive the motor brake, be sure to use a relay.</p> <p>When driving a load containing inductance component such as a relay, connect a protection circuit (diode). Install a diode in the direction shown in the figure below. The output circuit configuration is an open collector Darlington transistor output. Connects to relays and optical isolators. When the transistor is on, connector-emitter voltage VCE (SAT) is approximately 1V; a standard TTL IC does not satisfy VIL, and cannot be directly connected.</p> <p>The maximum rating of output circuit is 30V 50mA. Pin No.13 - 18 The emitter of output transistor is common to COM- of control power.</p> <p>Pin No.19, No.21 The emitter of output resistor is Pins No.20 and No.22 and independent of COM-.</p> | | | |
| | | | | |
| | | | | |
| | | | | |

5. Descriptions of CN1 Connector Signals

| CP | Connection to Pulse Train Command Signal | Control Mode | | |
|----|---|--------------|---|---|
| | | P | S | T |
| | <p>Use this for pulse train input in Position Control mode. You can set the form of pulse signal input with [Pulse train command: Input mode (No.32.0)]</p> <p>In case of positional disturbance due to noise, take noise countermeasures, for example,</p> <ol style="list-style-type: none"> 1) Make the signal line short between the host controller and the drive. 2) Be sure to use shielded twisted-pair cables for the signal lines. 3) Segregate the signal lines from the AC Supply cable and the motor power cable. 4) Adjust [Pulse train command: Input filter (No.33.0)]. | | | |
| | <p>Differential Max command pulse frequency: 4Mpps</p>  | | | |
| | <p>24V open collector Max command pulse frequency: 200kpps Be sure to set [Pulse train command Input filter (No.33.0)] to at least 7.</p>  | | | |
| | <p>5V open collector Max command pulse frequency: 200kpps Be sure to set [Pulse train command Input filter (No.33.0)] to at least 7.</p>  | | | |



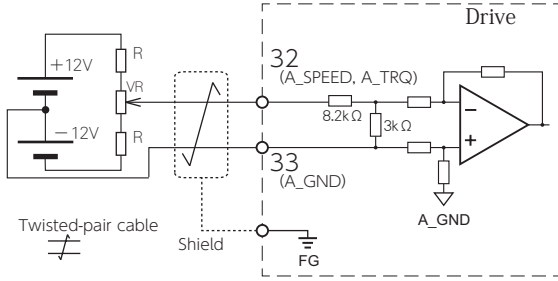





5. Descriptions of CN1 Connector Signals

| CA | Connection to Analog Command Signal | Control Mode | | |
|----|--|--------------|---|---|
| | | P | S | T |
| | <p>Input voltage tolerance range is ± 10 V. For input circuit impedance, see the figure below. For the command circuit configuration with a variable resistor (VR) and a resistor (R), VR must be $2\text{k}\Omega$ (1/4W or more) and R must be $100\ \Omega$ to $200\ \Omega$ (1/4W or more), so that command input voltage range is -10V to $+10\text{V}$. Be sure to use shielded twisted-pair cables as a noise countermeasure.</p> <p>■ Isolation/non-isolation of the host analog command circuit and 24V control power</p> <p>If isolated Connect A-GND with signal ground of the host controller. (Do not connect to GND of control power)</p> <p>If not isolated Connect A_GND with GND of control power.</p>  | |  |  |

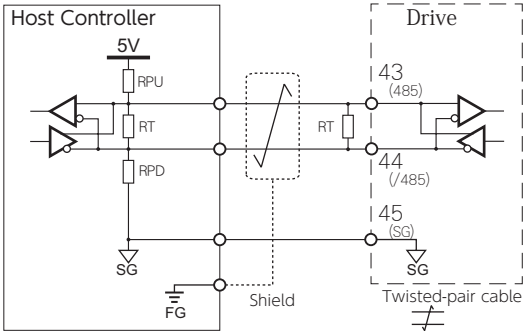
5. Descriptions of CN1 Connector Signals

| EO | Connection to Encoder Output Circuit | Control Mode | | |
|----|---|--------------|---|---|
| | | P | S | T |
| | <p>Differential output of encoder signal (A-phase, B-phase, Z-phase) which has been processed with pulse division ratio.</p> <p>Be sure to connect a termination resistor to the receiver circuit of the host controller. Approximately 220 Ω (1/4W or more)</p> <p>Signal ground of the communication IC in the output circuit is connected to signal ground inside the drive.</p> <p>Connect signal ground of communications IC of the host controller to Pin No.42.</p> <p>Be sure to use shielded twisted-pair cable as a noise countermeasure.</p> | | | |
| | <p>Encoder Z-phase is synchronized with A-phase and output.</p> | | | |

5. Descriptions of CN1 Connector Signals

| RS | Connection to RS-485 circuit | Control Mode | | |
|----|--|---|---|---|
| | | P | S | T |
| | <p>RS-485 communications with the host controller When connecting multiple drives, be sure to install a termination resistor of approximately 200 Ω between signal lines of the end drive. Be sure to connect a pull-up resistor (RPU) and a pull-down resistor (RPD) of approximately 1.2 k Ω inside the host controller. Be sure to connect a termination resistor of approximately 220 Ω.</p> <p>Make the wiring between the host controller and the drive less than 3m. Between drives, make it less than 1m.</p> <p>Signal ground of communication IC of the drive is connected to signal ground inside the drive. Connect signal ground of communications IC of the host controller to Pin No.45.</p> <p>Be sure to use shielded twisted-pair cable as a noise countermeasure.</p>  | | | |
| | |  |  |  |
| | |  |  |  |

| | |
|---|----|
| 1. Overview..... | 2 |
| 2. Setup Panel..... | 3 |
| 1. Setup Panel Features..... | 3 |
| Displaying A Number with 6 or More Digits..... | 4 |
| Selecting the digit to edit..... | 4 |
| 2. Using the Setup Panel..... | 5 |
| 3. Using the Setup Panel..... | 6 |
| 1. Status Display Mode..... | 7 |
| 2. Alarm Display Mode..... | 17 |
| 3. Parameter Setting Mode..... | 19 |
| 4. Quick Tuning Mode (Position Control Mode Only)..... | 20 |
| 5. Auto Tuning Mode (Position Control Mode)..... | 21 |
| 6. Auto Tuning Mode (Velocity Control Mode)..... | 22 |
| 7. Parameter Saving Mode..... | 23 |
| 8. Auxiliary Function Mode..... | 24 |
| 4. Overview of Digitax SF Connect (Setup Software)..... | 27 |
| 5. Parameters..... | 28 |
| 1. Parameters..... | 30 |
| 2. Details of Parameters..... | 34 |
| No.50.0 ~..... | 39 |
| No.120.0 ~..... | 52 |
| No.151.0 ~..... | 64 |
| No.224.0 ~..... | 68 |
| No.257.0 ~..... | 76 |
| No.300.0 ~..... | 82 |
| No.357.0 ~..... | 84 |
| No.642.0 ~..... | 88 |
| No.720.0 ~..... | 96 |
| 3. Point Table Parameter List..... | 98 |

This section explains a variety of parameters that are required to set up the various product functions and features. Read this section carefully to become familiar with the setup methods, functions, and usages of the parameters, then adjust the parameters to best suit your operating requirements.

Parameter Tuning Method



Tuning with the Setup Panel on the front the drive.









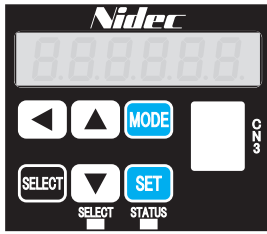

Tuning with the setup software Digitax SF Connect.
Install it on the user-supplied PC.

2. Setup Panel

1. Setup Panel Features



Setup Panel



| Items | Descriptions | | | | | | | | | | | |
|--|--|-----------------|-----|--------|----|----------|--------|--------|-----------------|-----|-----|--------|
|  Display Panel | Displays a status or a setting value (with six digits at a time) on 7-segment display. | | | | | | | | | | | |
|  MODE Button | Use this button to switch between the six modes in the main menu or return to the main menu. | | | | | | | | | | | |
|  SET Button | Use this button to select items and set values. | | | | | | | | | | | |
|  STATUS LED | <table border="1"> <thead> <tr> <th>Control power</th> <th>LED</th> <th>Status</th> </tr> </thead> <tbody> <tr> <td rowspan="2">ON</td> <td>Green ON</td> <td>Normal</td> </tr> <tr> <td>Red ON</td> <td>Alarm occurring</td> </tr> <tr> <td>OFF</td> <td>OFF</td> <td>Normal</td> </tr> </tbody> </table> | Control power | LED | Status | ON | Green ON | Normal | Red ON | Alarm occurring | OFF | OFF | Normal |
| Control power | LED | Status | | | | | | | | | | |
| ON | Green ON | Normal | | | | | | | | | | |
| | Red ON | Alarm occurring | | | | | | | | | | |
| OFF | OFF | Normal | | | | | | | | | | |
|  UP Button | In each mode, use these buttons to change the display item, change data, select the parameter, execute operation and so forth. Use  to increase or  to decrease a numeric value | | | | | | | | | | | |
|  DOWN Button | | | | | | | | | | | | |
|  LEFT Button | Use this button to move to higher order digits when changing the data. | | | | | | | | | | | |



Do not press more than one button simultaneously on the Setup Panel.
 Otherwise, the information displayed on the DISPLAY LED will be incomplete.

2. Setup Panel

Displaying A Number with 6 or More Digits

You can display a 6 to 10-digit number on the display panel with 3 separate portions, 5 digits at a time. The leftmost letter indicates which segment of the number is currently displayed: sign , first 5-digit , or last 5-digit  segment. The last 5-digit segment is displayed first.

ex. 1 : Positive number

+1,234,567,890

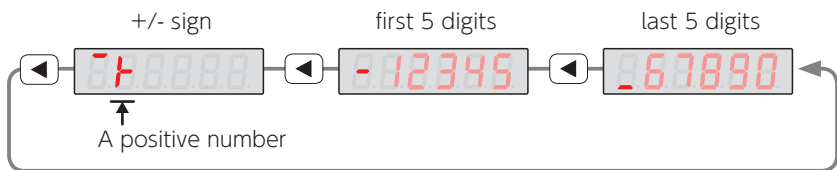

ex. 2 : Negative number

-1,000,000,000

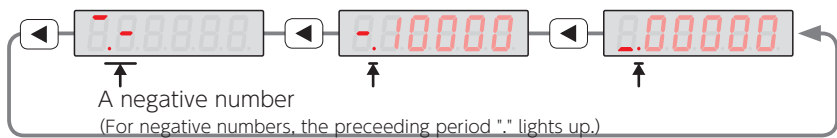

ex. 3 : Model Code and Serial Number

0002020400



Selecting the digit to edit

Use  button to move the blinking position to the digit place that you want to edit.



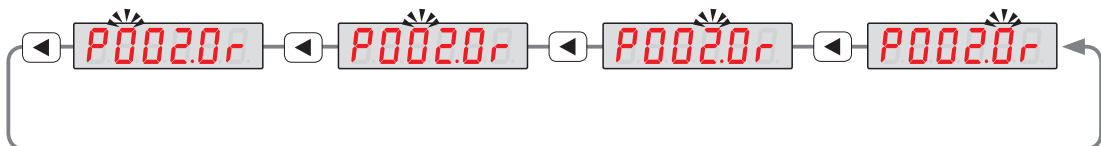



Use   button to change the value of the blinking digit.



2. Setup Panel

2. Using the Setup Panel

The Setup Panel shows seven modes, each of which represents a group of functions.

| Display Mode | Overview |
|--|--|
|  Status Display Mode | Motor and drive statuses can be verified. Not displayed when an alarm is occurring |
|  Alarm Status Display Mode | You can check the active alarm in this mode. |
|  Parameter Edit Mode | Use this mode to edit each parameter |
|  Quick Tuning Mode | This mode is used for tuning the control gain set based on the selected inertia. (Position Control Mode only) |
|  Auto Tuning Mode | This mode is used to set up the parameters required for auto tuning. Not available in Torque Control Mode. |
|  Parameter Saving Mode | This mode enables you to save the parameters set up in Parameter Setting Mode or Auto Tuning Mode to EEPROM. |
|  Auxiliary Function Mode | You can perform: <ul style="list-style-type: none"> - JOG Operation to execute testing with no command input from the host controller. - Clear Parameter to reset all parameters to the factory default. - Clear Encoder to initialize multi-turn data of absolute encoder. |

Character table for 7-segment LED display

| A | B | C | D | E | F | G | H | I | J | K | L | M | N | O | P | Q | R | S | T |
|---|---|---|---|---|---|---|---|---|---|---|---|---|---|---|---|---|---|---|---|
| A | B | C | D | E | F | G | H | I | J | K | L | M | N | O | P | Q | R | S | T |
| | | | | | | | | | | | | | | | | | | | |
| S | T | U | V | W | X | Y | Z | 0 | 1 | 2 | 3 | 4 | 5 | 6 | 7 | 8 | 9 | + | - |
| | | | | | | | | | | | | | | | | | | | |

5. Settings

3. Using the Setup Panel

Turn on the control power of the drive and then press **MODE** twice to bring up the main menu. On the main menu, select the mode you are to set up, then press **SET** to see the sub-menu.

Turn the control power on.

Initial display

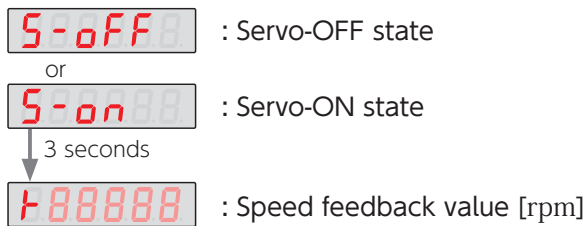

Main Menu

Sub-menu

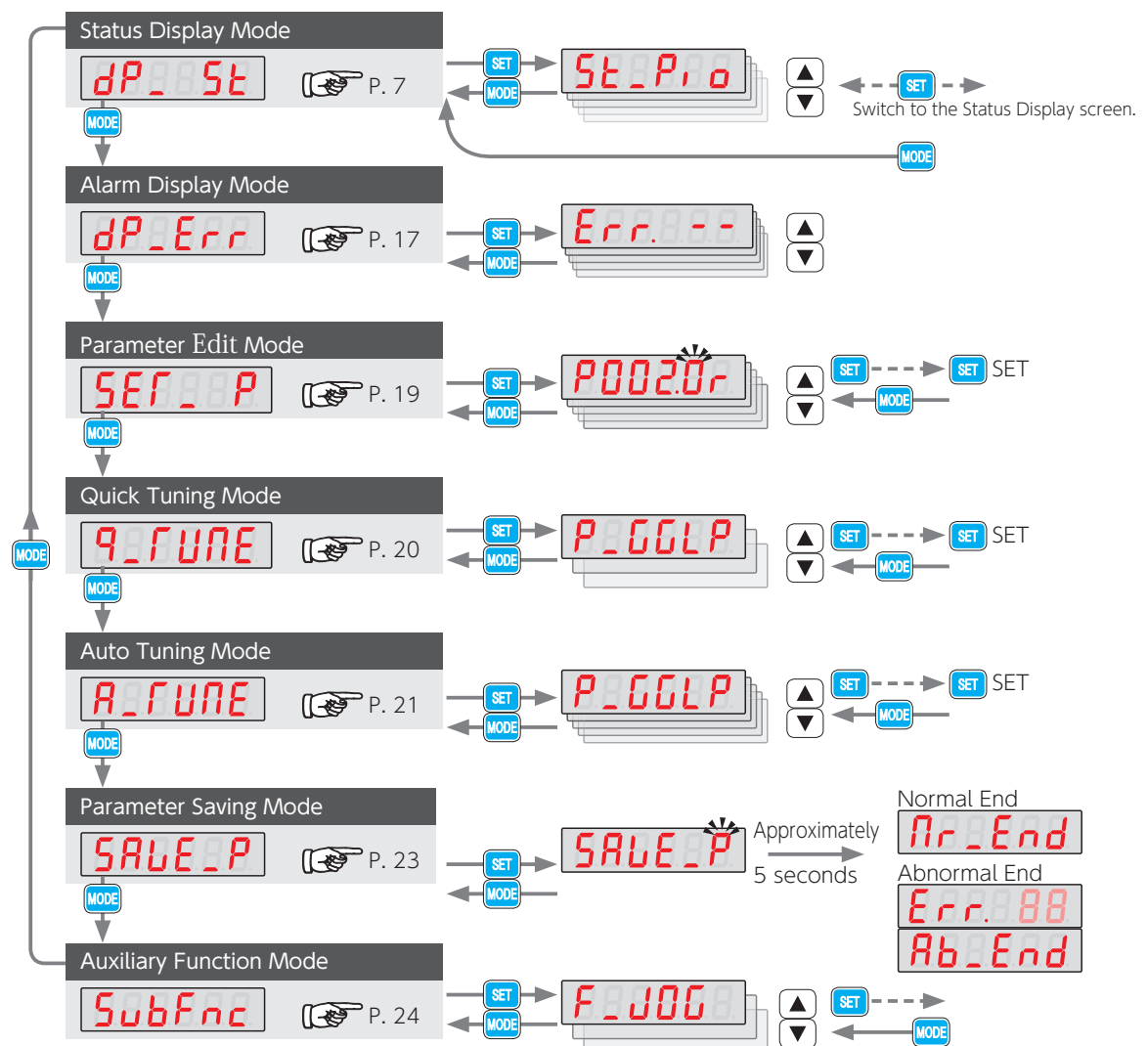

3. Using the Setup Panel

1. Status Display Mode

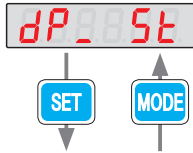

On the sub-menu that you just selected, press **SET** to display a value or proceed to the next setup screen.

Following pages for each sub-menu
9 Appendix Status List

| Sub-menu | |
|----------|--|
| 1 | St_Pio I/O Status (P. 8) |
| 2 | St_t7P Control Component Temperature (reference value) (P. 9) |
| 3 | St_PCP Pulse Train Command Input (Position) (P. 9) |
| 4 | St_PCS Pulse Train Command Input (Speed) (P. 9) |
| 5 | St_ASC Analog Velocity Command (P. 9) |
| 6 | St_PPS Positioning Status (P. 10) |
| 7 | St_PCA ABS Position Command (P. 10) |
| 8 | St_PFA ABS Position Feedback (P. 10) |
| 9 | St_PdC Command Position Error (P. 10) |
| 10 | St_PdA ABS Position Error (P. 11) |
| 11 | St_PCo Position Command Value (P. 11) |
| 12 | St_PFb Position Feedback (P. 11) |
| 13 | St_PdU Position Error (P. 11) |
| 14 | St_SCo Speed Command Setting (P. 12) |
| 15 | St_SFb Speed Feedback (P. 12) |
| 16 | St_SdU Speed Error (P. 12) |
| 17 | St_t79 Torque Command Value (P. 12) |
| 18 | St_LoF Load Factor (P. 13) |
| 19 | St_inr Estimated Inertia Ratio (P. 13) |
| 20 | St_ESt Encoder Rotor Mechanical Angle (single-turn) (P. 13) |
| 21 | St_EAb Encoder Rotor Mechanical Angle (multiple-turns) (P. 13) |
| 22 | St_EtP Encoder Temperature (reference value) (P. 14) |
| 23 | St_EbU Encoder Battery Voltage (P. 14) |
| 24 | St_EAc Encoder Communication: No. of Retries (P. 14) |
| 25 | St_EEC Encoder Data Error Count (P. 14) |
| 26 | St_AEG Regeneration Status (P. 15) |
| 27 | St_PnU AC Supply Voltage (reference value) (P. 16) |
| 28 | Pt_drb Drive Model Code (P. 16) |
| | Pt_Dot Motor Model Code |
| | Pt_Enc Encoder Model Code |
| 29 | PS_drb Drive Serial Number (P. 16) |
| | PS_Dot Motor Serial Number |
| | PS_Enc Encoder Serial Number |
| 1 | St_Pio I/O Status (P. 8) |
| | ⋮ |

Press **▲** for the direction of the flow (↓) . Press **▼** for the reverse direction.

3. Using the Setup Panel

1 I/O Status

Status No.16

The flow chart below illustrates the I/O status of the CN1 connector.
The assignments of I/O pins depend on each control mode. Check each corresponding pin.

 4 Connections

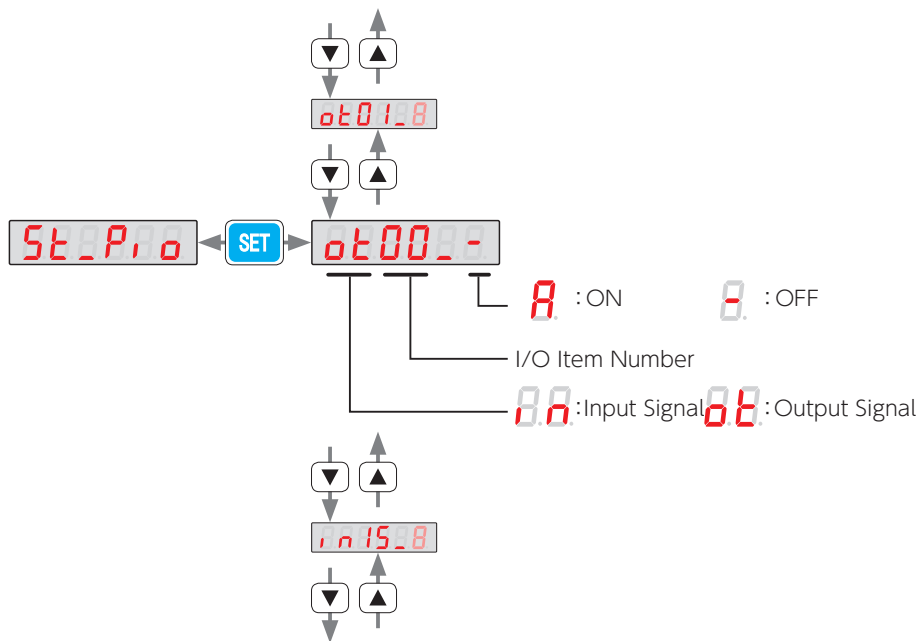

| Output Signal | Pin No. | Input Signal | Pin No. |
|---------------|----------|--------------|----------|
| ot00_8 | 13 | in00_8 | 4 |
| ot01_8 | 14 | in01_8 | 5 |
| ot02_8 | 15 | in02_8 | 6 |
| ot03_8 | 16 | in03_8 | 7 |
| ot04_8 | 17 | in04_8 | 8 |
| ot05_8 (*) | 18 | in05_8 | 9 |
| ot06_8 | 19 | in06_8 | 10 |
| ot07_8 | 21 | in07_8 | 11 |
| ot08_8 | | in08_8 | |
| ... | Reserved | ... | Reserved |
| ot15_8 | | in15_8 | |

*) NOTE: The display of ot05_8 is fixed at 8 (OFF).

3. Using the Setup Panel

2 Control Component Temperature Status No.24

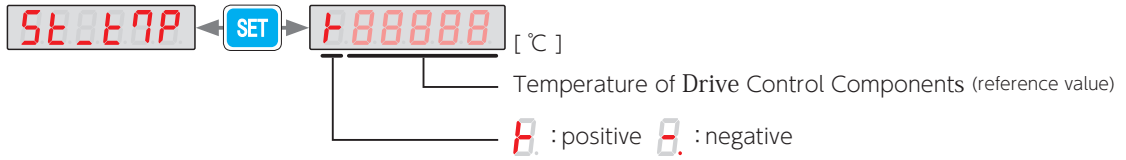

3 Pulse Train Command Input (Position) Status No.33

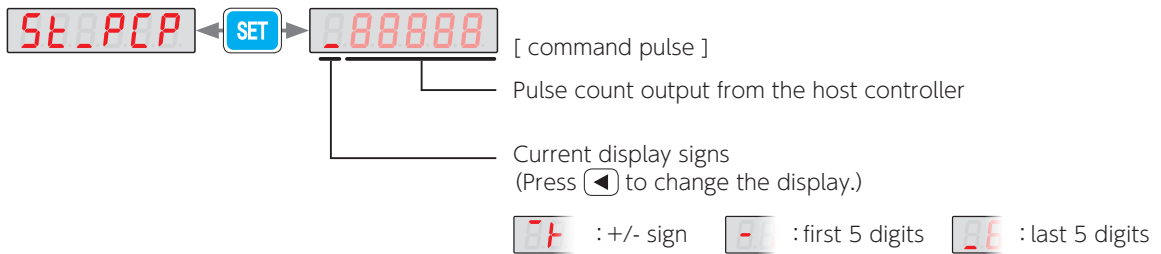

4 Pulse Train Command Input (Speed) Status No.35

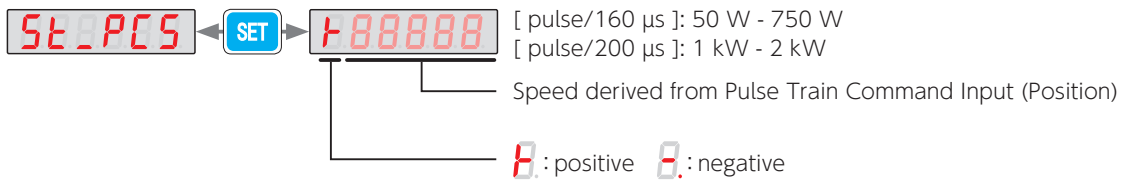

5 Analog Velocity Command Status No.49

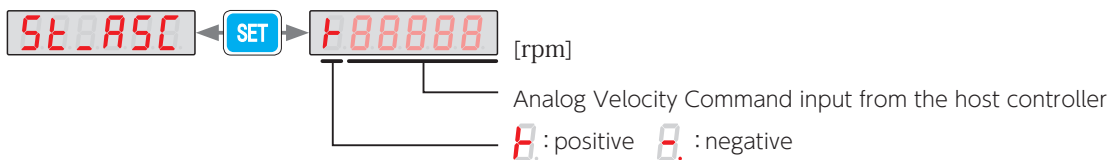

3. Using the Setup Panel

6 Positioning Status

Status No.64

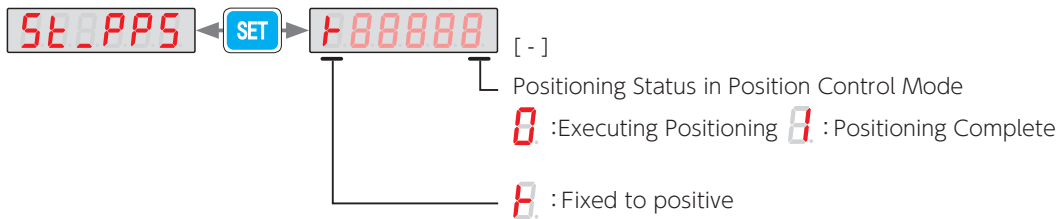

7 ABS Position Command

Status No.74

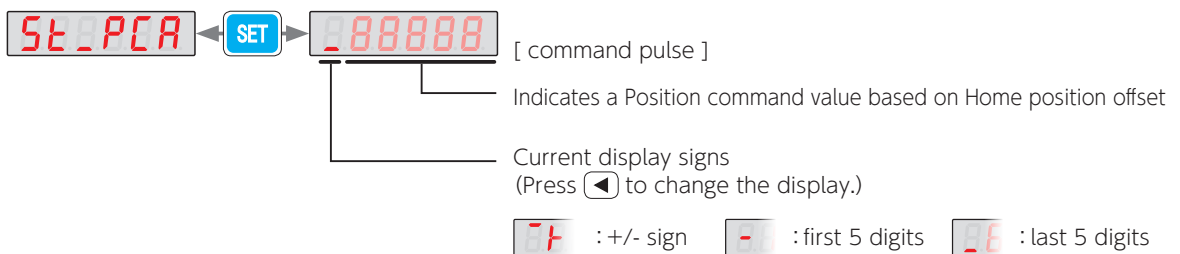

8 ABS Position Feedback

Status No.76

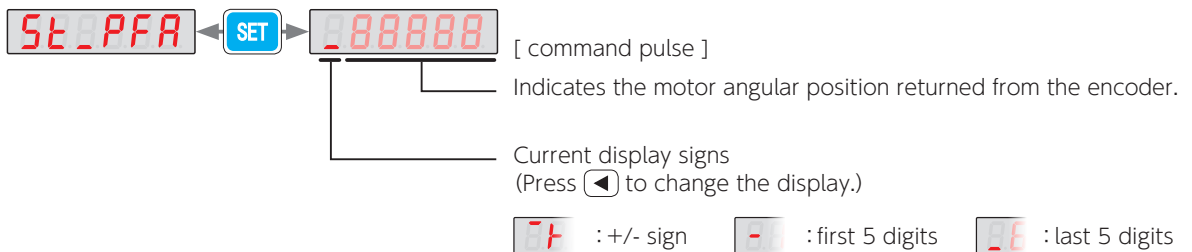

9 Command Position Error

Status No.78

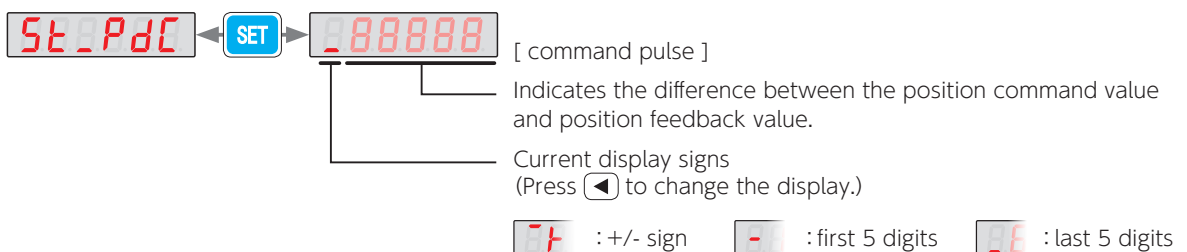

3. Using the Setup Panel

10 ABS Position Error Status No.80

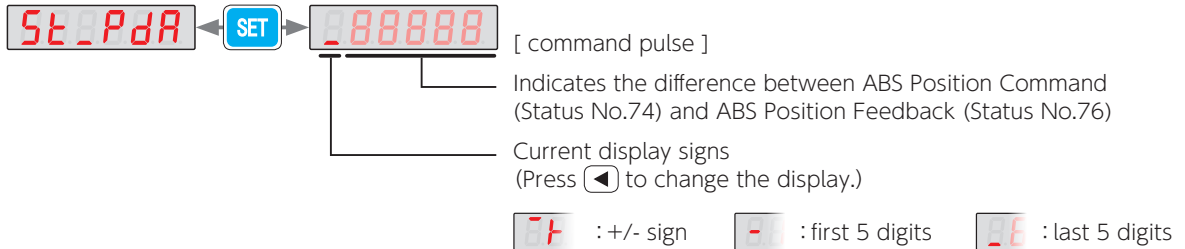

11 Position Command Value Status No.65

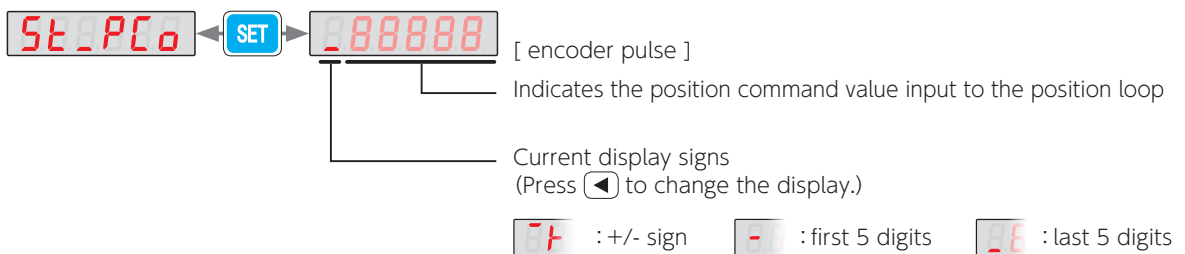

12 Position Feedback Status No.67

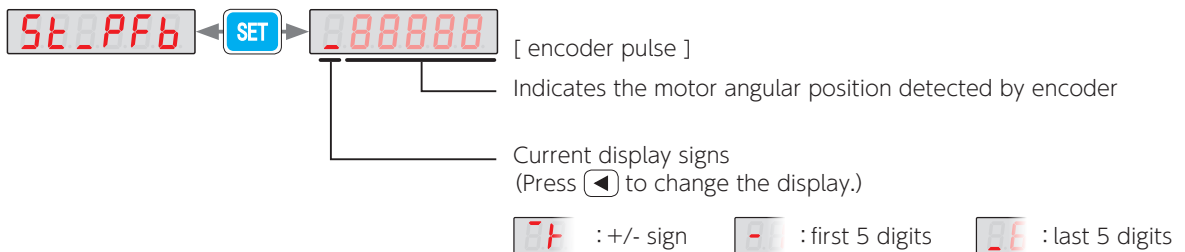

13 Position Error Status No.69

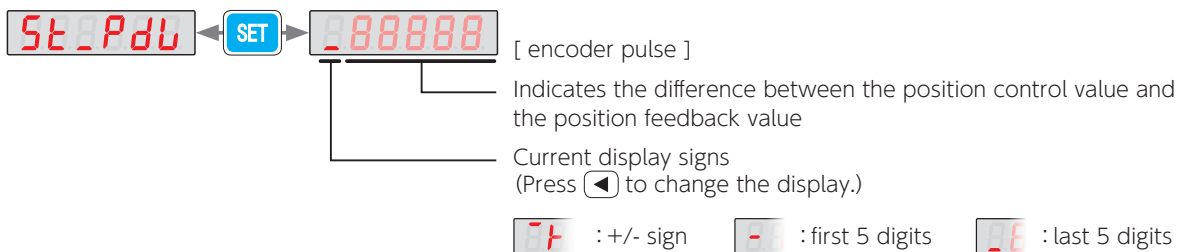

3. Using the Setup Panel

14 Speed Command Setting

Status No.97

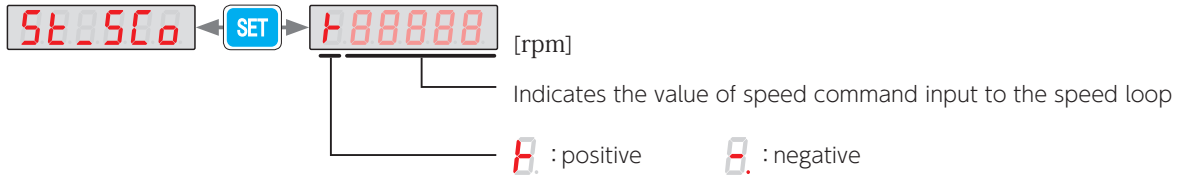

15 Speed Feedback

Status No.98

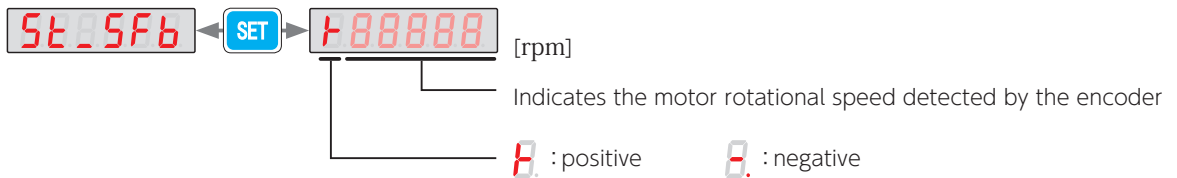

16 Speed Error

Status No.99

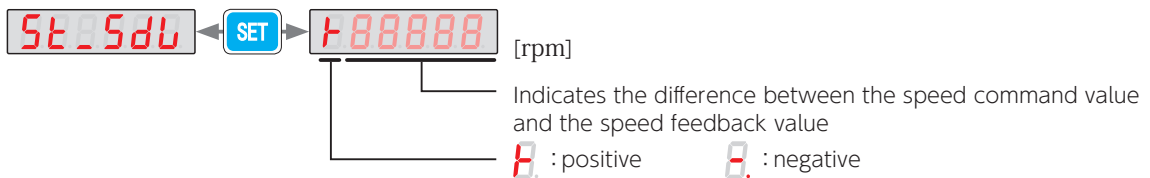

17 Torque Command Value

Status No.113

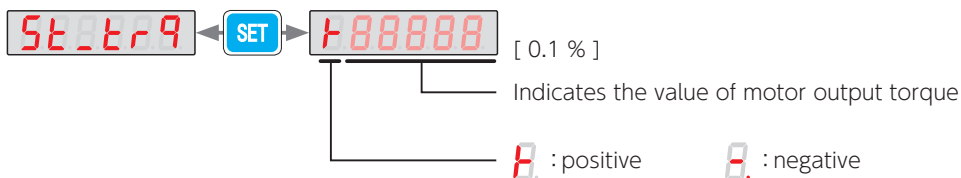

3. Using the Setup Panel

18 Load Factor Status No.131

[digit]

Indicates the load factor threshold to detect overload

To compare the displayed value to 100% rated torque, use the following conversion formula:

$$\sqrt{\text{Load Factor [digit]} \times 10} [\%]$$

1. : positive .1 : negative

19 Estimated Inertia Ratio Status No.371

[%]

Indicates the estimated inertia ratio (Indicates 250 % in this example.)

20 Encoder Rotor Mechanical Angle (Single Turn) Status No.194

[encoder pulse]

Indicates the single-turn absolute value of the motor

Current display signs (Press to change the display.)

-+ : +/- sign - : first 5 digits -8 : last 5 digits

21 Encoder Rotor Mechanical Angle (Multi-turn) Status No.195

[encoder pulse]

Indicates the cumulative value of the motor's multiple-turns

Current display signs (Press to change the display.)

-+ : +/- sign - : first 5 digits -8 : last 5 digits

3. Using the Setup Panel

22 Encoder Temperature

Status No.205



23 Encoder Battery Voltage

Status No.206

(Absolute encoder only)



24 Encoder Communication Retry Count

Status No.216

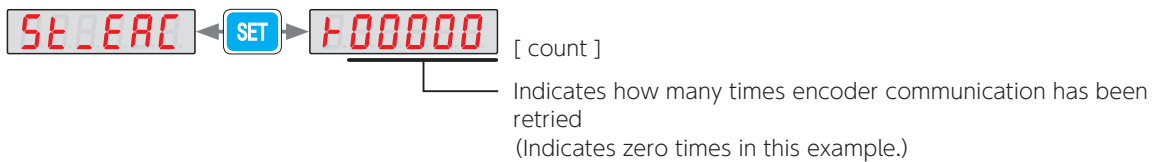

25 Encoder Data Error Counter

Status No.218

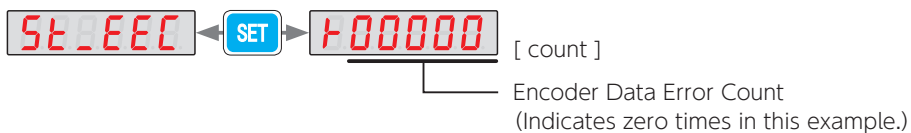

26 Regeneration Status

Status No.228

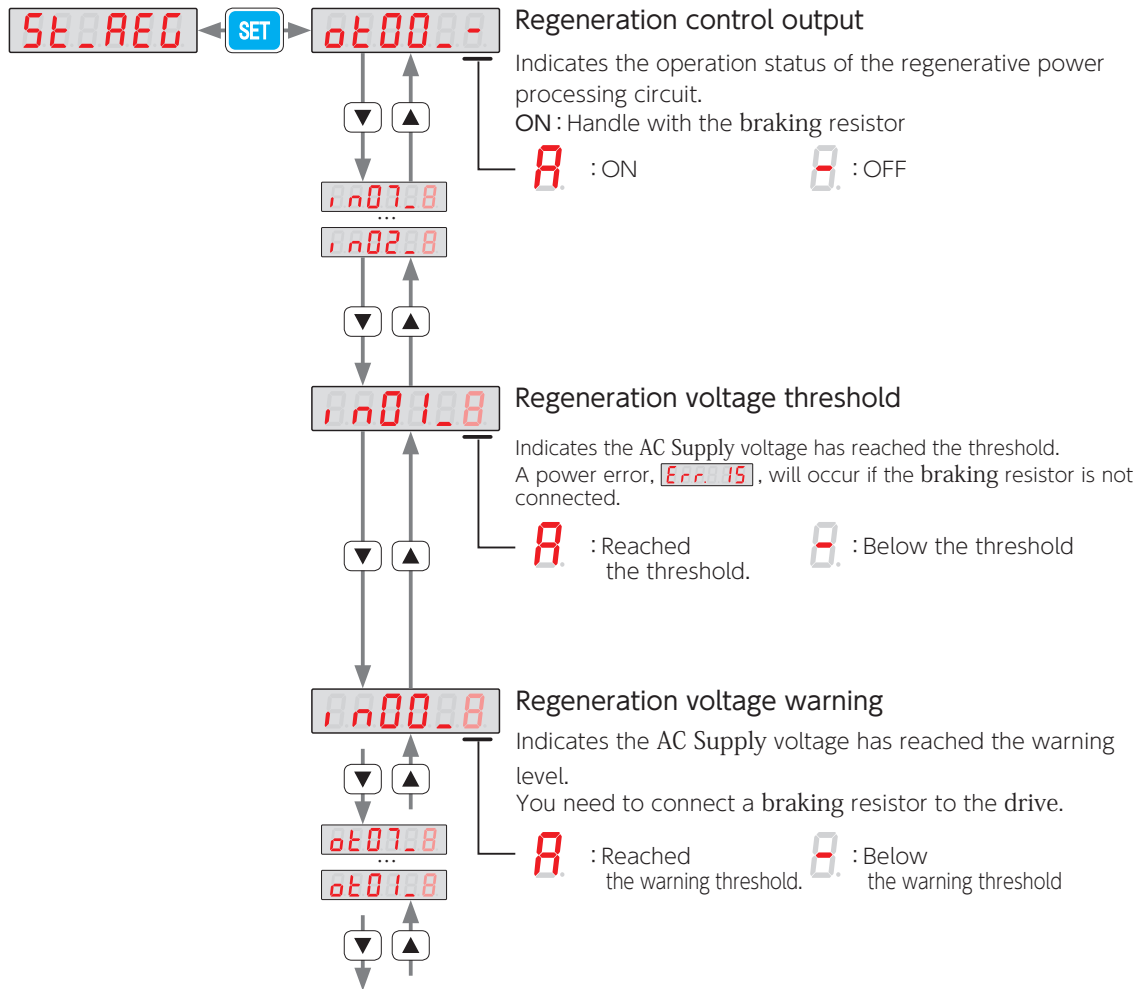

How to determine whether or not a braking resistor is needed

1. Display **rn00_8** as instructed above.
2. Observe if the display on the Setup Panel while gradually increasing the speed of the equipment from a low speed (approximately 20 % of the max speed) to the actual operating speed.

rn00_- : you do not need install a braking resistor.

rn00_A : install a braking resistor.

3 Preparation Braking Resistor

CAUTION



If **Err. 15** appears while the motor is decelerating, you may need a braking resistor. Determine if a braking resistor is necessary or not as described above.



3. Using the Setup Panel

27 AC Supply Power Voltage

Status No.232

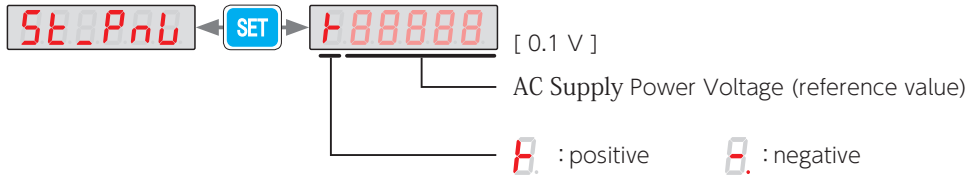

28 Model Code (Drive, Motor, Encoder)

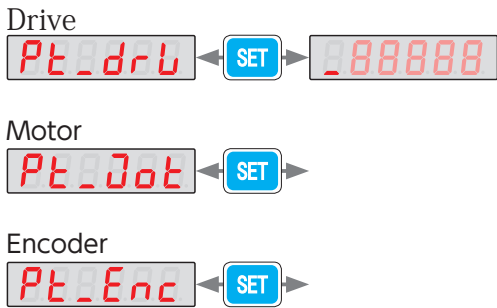

29 Serial Number (Drive, Motor, Encoder)

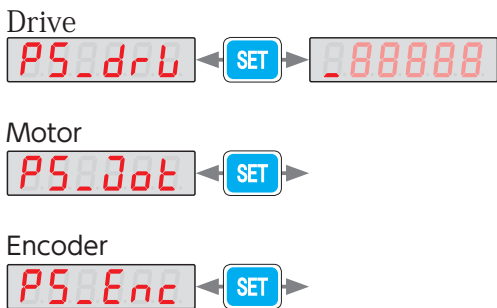

3. Using the Setup Panel

2. Alarm Display Mode

When an alarm occurs, the Setup Panel will automatically switch to the Alarm Display Mode. Note that this does not happen in the following modes: Parameter Setting Mode, Quick Tuning Mode, Auto Tuning Mode, Parameter Saving Mode, and Auxiliary Function Mode. To switch to Alarm Display Mode from one of these modes, press **MODE**. Status Display Mode is disabled while an alarm is occurring. Up to 10 previous alarms can be displayed.

8 Troubleshooting

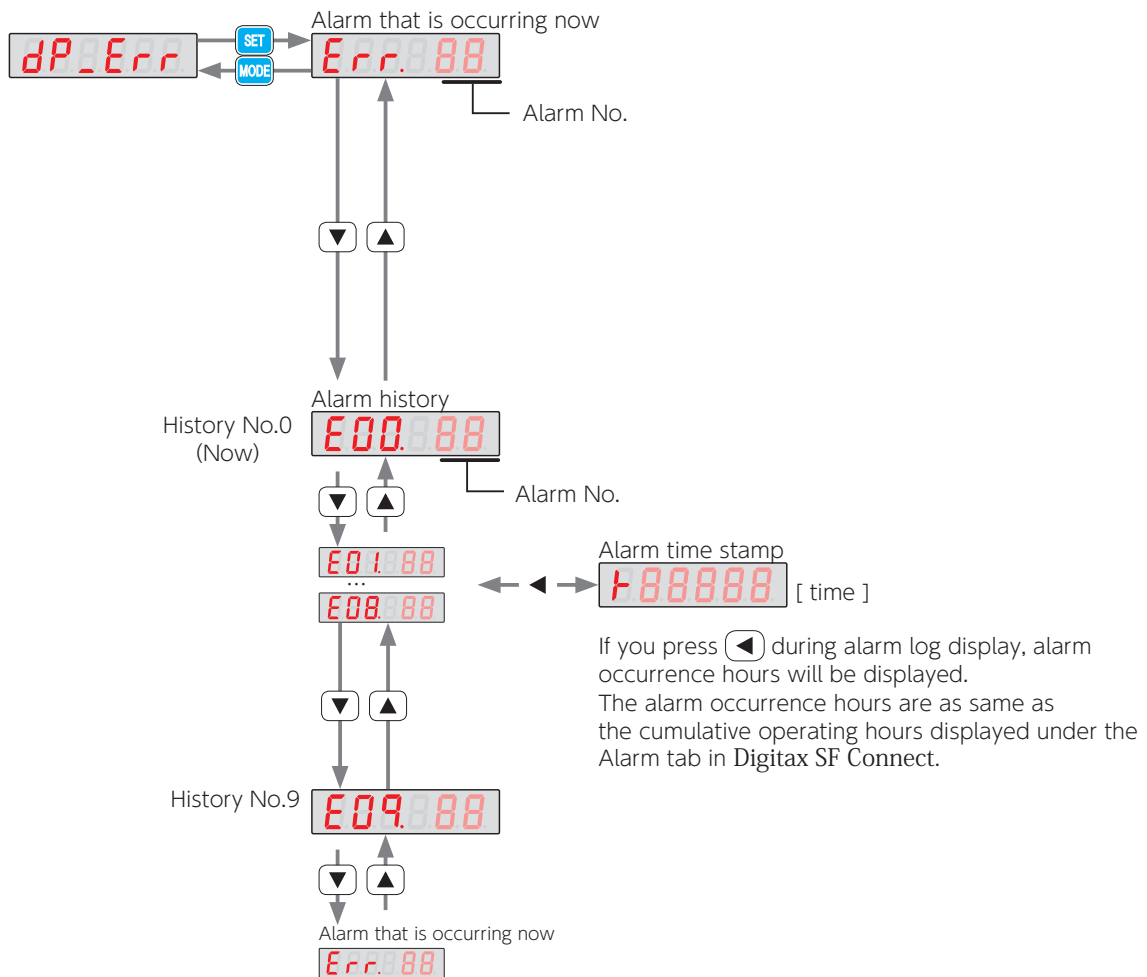

3. Using the Setup Panel

List of Alarms

| Display | Alarm | Display | Alarm |
|---------|--|---------|---------------------------------|
| Err. -- | No alarm | Err. 16 | Encoder (Received data) |
| Err. 00 | System | Err. 17 | Encoder (no response) |
| Err. 01 | EEPROM data | Err. 18 | Encoder (circuitry) |
| Err. 02 | Product code | Err. 19 | Encoder (communication) |
| Err. 04 | Overspeed | Err. 20 | Encoder (multi-turn data) |
| Err. 05 | Speed | Err. 21 | Encoder (voltage drop) |
| Err. 06 | Position | Err. 22 | Voltage (control power) |
| Err. 07 | Overload | Err. 23 | Switch circuitry |
| Err. 08 | Command overspeed | Err. 24 | Overcurrent |
| Err. 09 | Encoder pulse Output frequency | Err. 25 | Inverter 1 |
| Err. 10 | Internal Position Command overflow Homing failure | Err. 26 | Inverter 2 |
| Err. 11 | Encoder (multi-turn counter overflow) | Err. 27 | Current sensor |
| Err. 12 | Overheat | Err. 28 | Encoder (overheat) |
| Err. 14 | Overvoltage | Err. 29 | Voltage drop (inside the drive) |
| Err. 15 | Power supply (AC Supply) | | |

List of Warnings

| Display | Warning | Display | Warning |
|---------|---|---------|-------------------------------|
| Err.900 | Encoder overheat detection | Err.903 | Encoder communication warning |
| Err.901 | Encoder battery voltage drop error detection | Err.904 | Excessive position error |
| Err.902 | Emergency stop | | |

3. Parameter Setting Mode

In Parameter Setting Mode, drive parameters can be checked and set up. For details of each parameter, see the Parameters.

Page 28

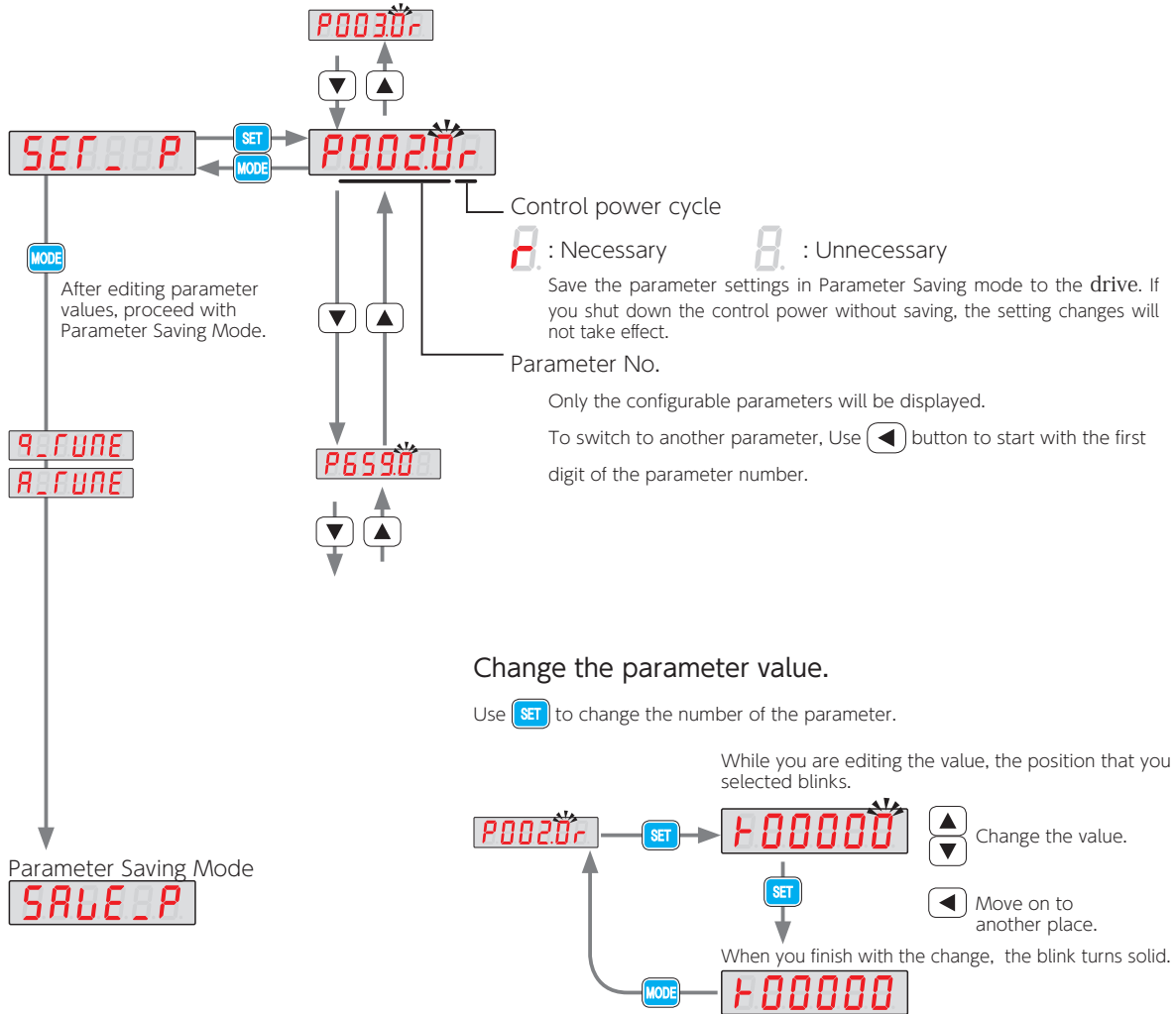

Save the parameter settings in Parameter Saving mode to the drive. If you shut down the drive without saving them, the changes will not take effect.

3. Using the Setup Panel

4. Quick Tuning Mode (Position Control Mode Only)

For Tuning Procedures, see [7 Tuning](#).

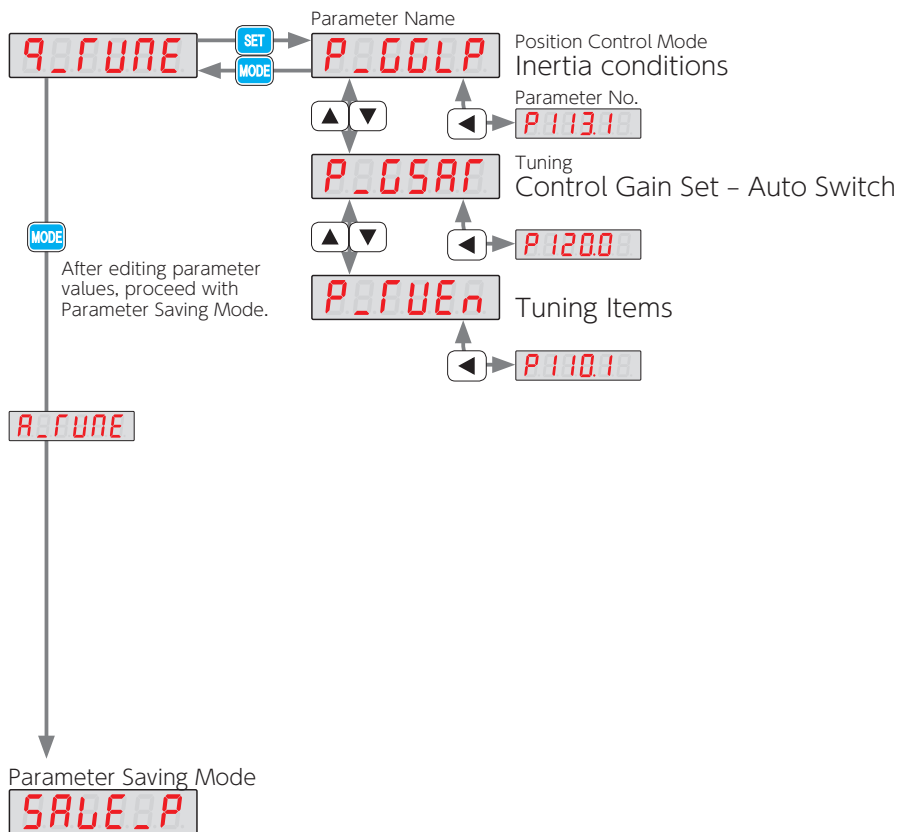

Save the parameter settings in Parameter Saving mode to the drive. If you shut down the drive without saving them, the changes will not take effect.

For Tuning Procedures, see 7 Tuning.

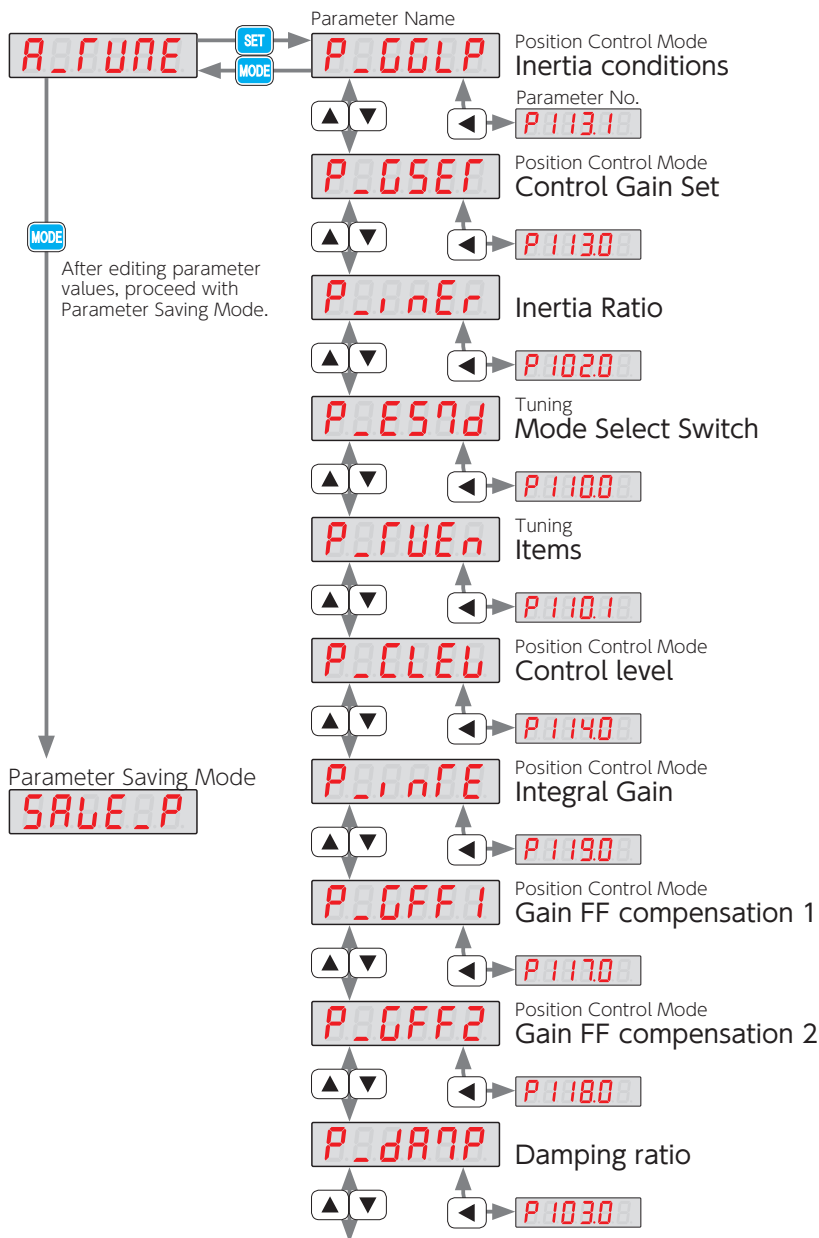

Save the parameter settings in Parameter Saving mode to the drive. If you shut down the drive without saving them, the changes will not take effect.

3. Using the Setup Panel

6. Auto Tuning Mode (Velocity Control Mode)

For Tuning Procedures, see 7 Tuning.

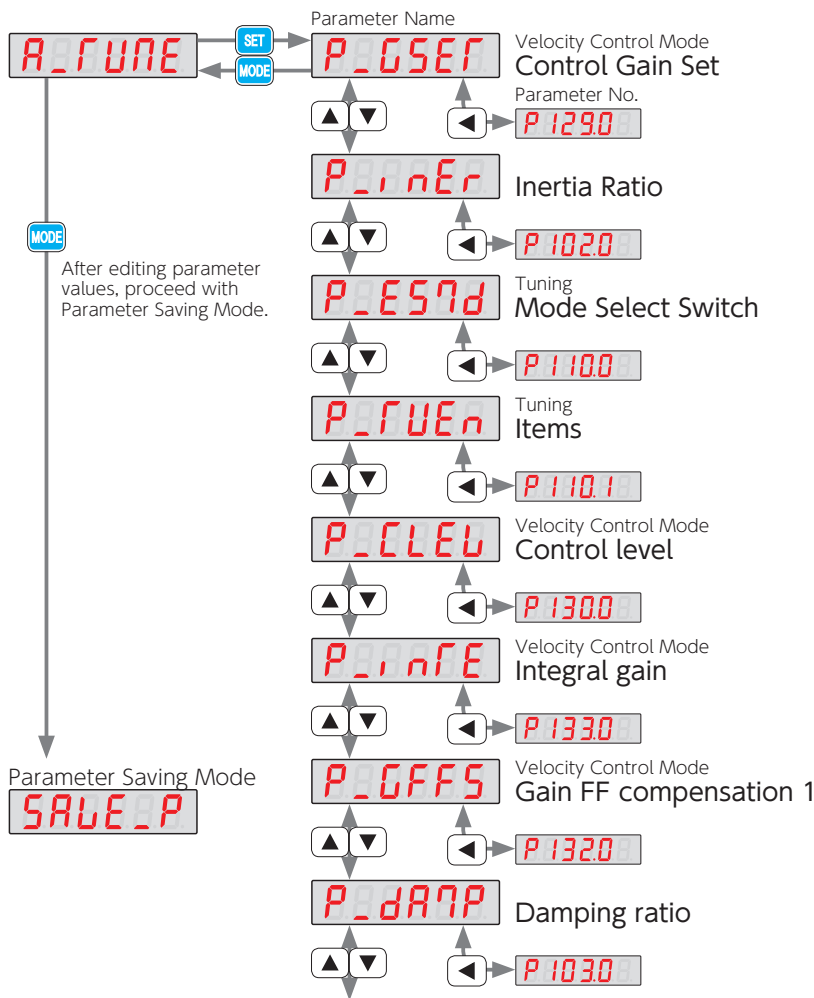

Save the parameter settings in Parameter Saving mode to the drive. If you shut down the drive without saving them, the changes will not take effect.

3. Using the Setup Panel

7. Parameter Saving Mode

This mode allows you to save the parameter settings changed in Parameter Setting Mode or Auto Tuning Mode.

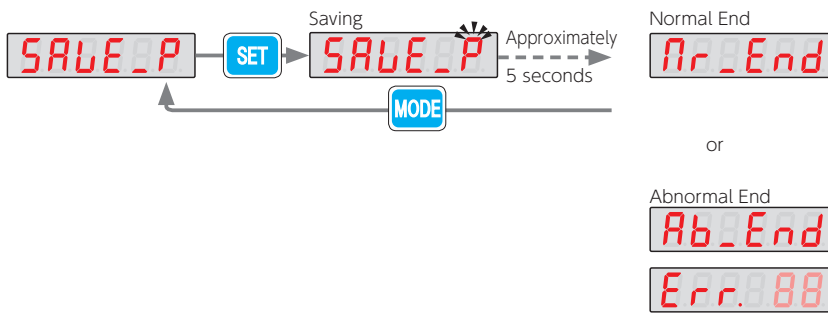

Check in Alarm Display Mode.



Save the parameter settings in Parameter Saving mode to the drive. If you shut down the drive without saving them, the changes will not take effect.

If you changed parameters for which control-power cycle is needed, cycle power after the new parameter settings are saved.

Auxiliary Function Mode allows you to perform the operations such as 1) JOG operation, 2) Clear Parameter, and 3) Clear Encoder.

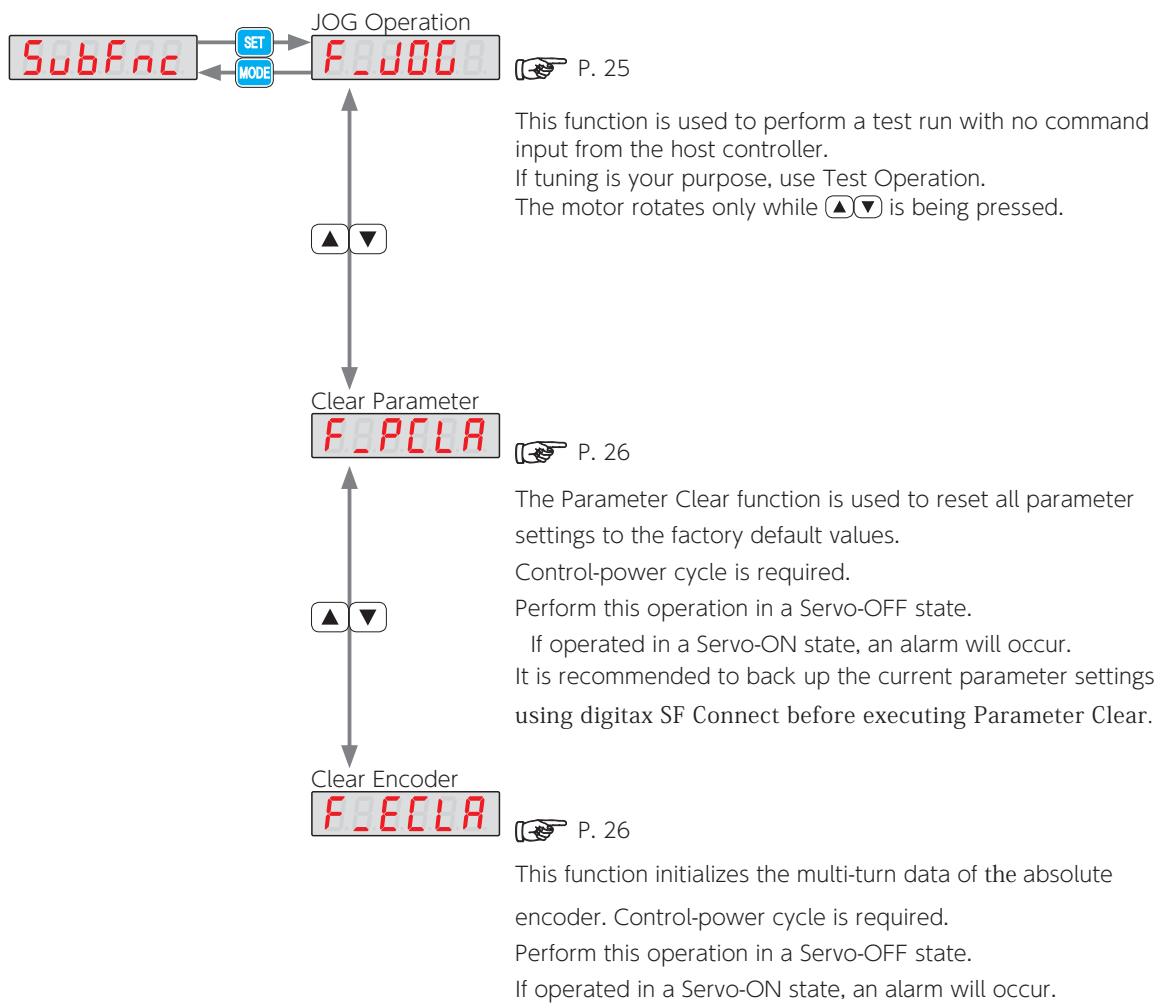

JOG Operation

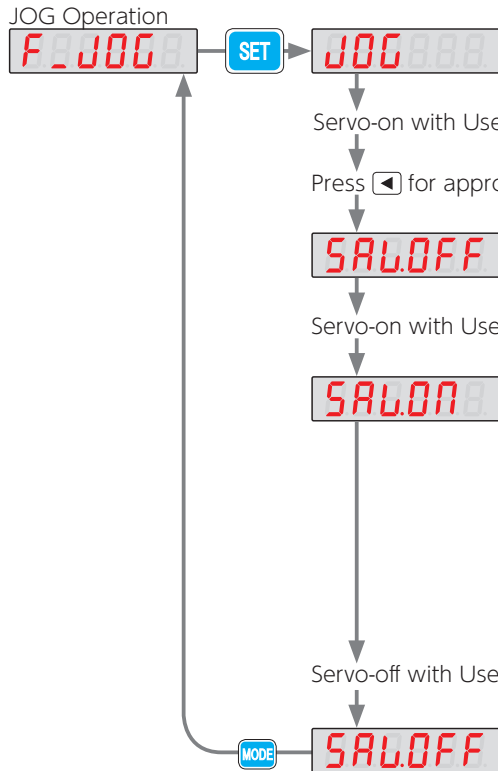

JOG operation starts.

- Move the motor using ▲ or ▼ button.
- The motor moves only when either button is pressed.
- Press ▲▼ at the same time to stop the motor.
- For an emergency stop, shut off the AC supply or turn the servo off.

Rotational direction

- ▲ : CCW rotation
- ▼ : CW rotation

*1) Pressing ◀ without turning the servo off will result in **Error**. Press **MODE** to be back to **F_JOG**.

*2) Press **MODE** without turning the servo off, **Error** will be displayed first and then **SALON** in approximately 3 seconds.

Modes and conditions that allow JOG Operation

| Control Mode | Command Mode | JOG Operation |
|------------------|---------------------------|---------------|
| Position Control | Pulse Train Command | Yes |
| | Internal Position Command | No |
| Velocity Control | Analog Velocity Command | Yes |
| | Internal Velocity Command | Yes (*) |
| Torque Control | Analog Torque Command | No |

*) Speed selection by I/O input is disabled. (VCRUN1, VCRUN2, VCSEL1, VCSEL2, VCSEL3)

JOG Operation related parameters

| No. | Parameter | Default | Range |
|-----------|-------------------|------------|---|
| 385.0 | Acceleration Time | 1,000 [ms] | 0 to 60,000 |
| 386.0 (*) | Deceleration Time | 1,000 [ms] | 0 to 60,000 |
| 387.0 | Target Speed | 300 [rpm] | 0 to max of motor rotational speed of motor |

*) The larger the setting, is the longer it takes for the motor to stop after releasing any of the ▲▼ buttons.

3. Using the Setup Panel

Clear Parameter

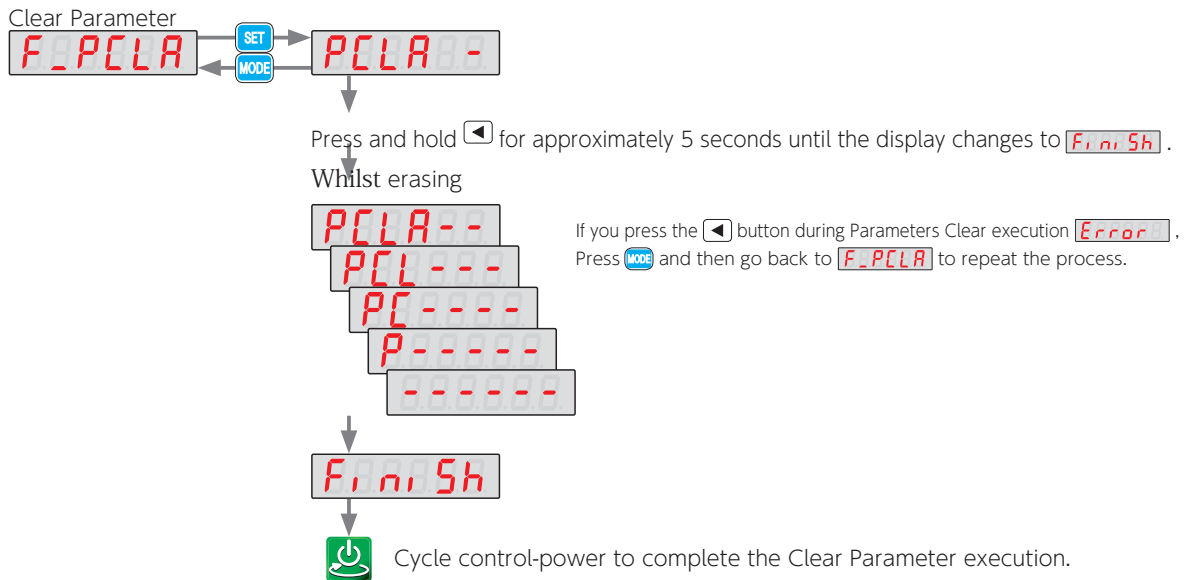

Use this in a Servo-OFF state.

If used in a Servo-ON state, an alarm will occur.

Clear Encoder (This feature is used in absolute systems)

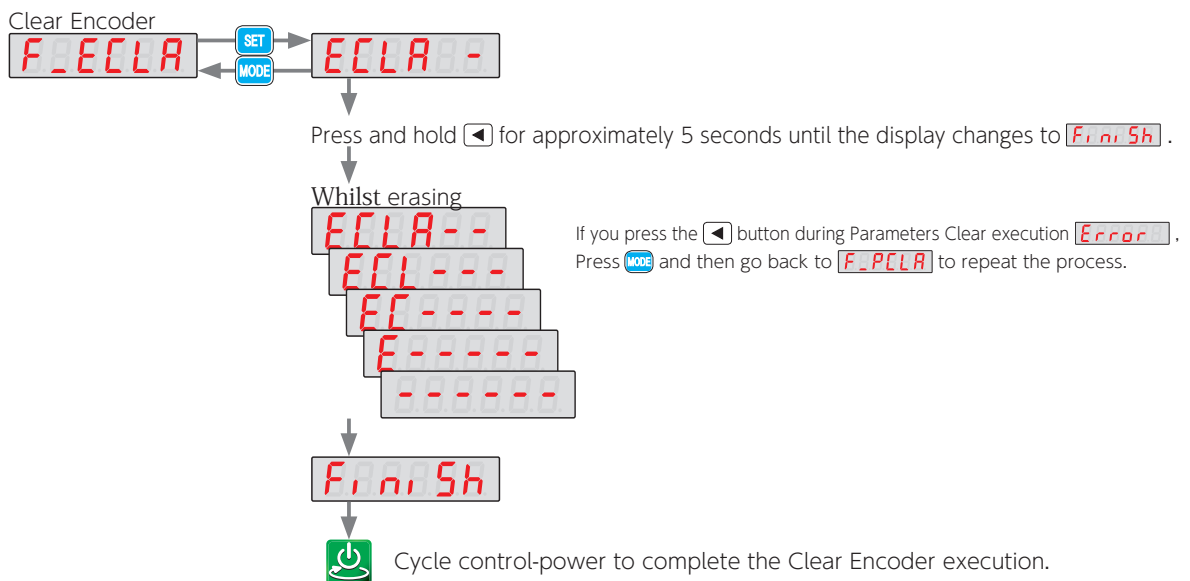

Use this in a Servo-OFF state.

If used in a Servo-ON state, an alarm will occur.

4. Overview of Digitax SF Connect (Setup Software)

Digitax SF Connect is a dedicated setup software to be installed on a user-supplied PC connecting to a **Digitax SF** servo drive with a USB cable. It enables you to perform the following operations easily.

Features:

- setting, saving, and writing drive parameters
- measuring, saving, and comparing data, by using a graphical waveform monitor
- monitoring the state of drive, alarm, and input/output
- gain tuning and setting filters
- point-table operation, test operation and homing

System Requirements for Digitax SF Connect

| Product | Specifications | |
|---------|-------------------------|--|
| PC | OS | Windows® XP SP3 (32-bit) Windows® 7 (32-bit, 64-bit) Windows® 8 (64-bit) |
| | Language | Japanese, Chinese (Simplified), Chinese (Traditional), Korean, and English |
| | Minimum CPU | Pentium® III 512 MHz |
| | Minimum Memory | 256 MB (512 MB recommended) |
| | Minimum Hard Disk Space | 512 MB free space |
| | Serial Communications | USB port |
| Cable | USB A – USB mini B | In noisy environments, a signal noise filter cable is recommended. |

Connecting Drive and PC

Install **Digitax SF Connect** on your PC.
Connect a USB cable to CN3 at the front of the drive.

 [Digitax SF Connect Instruction Manual](#)



5. Settings

5. Parameters

Remark

Some of the tuning parameters are dependent on the settings of other parameters, which makes the values of dependent parameters invalid even if they are within the specification range.

| Control Mode | Name | No. |
|-----------------------|------------------------|-------|
| Position Control Mode | Control gain 1 | 115.0 |
| | Control gain 2 | 116.0 |
| | Gain FF compensation 1 | 117.0 |
| | Gain FF compensation 2 | 118.0 |
| | Integral gain | 119.0 |
| Velocity Control Mode | Control gain 1 | 131.0 |
| | Gain FF Compensation 1 | 132.0 |
| | Integral gain | 133.0 |





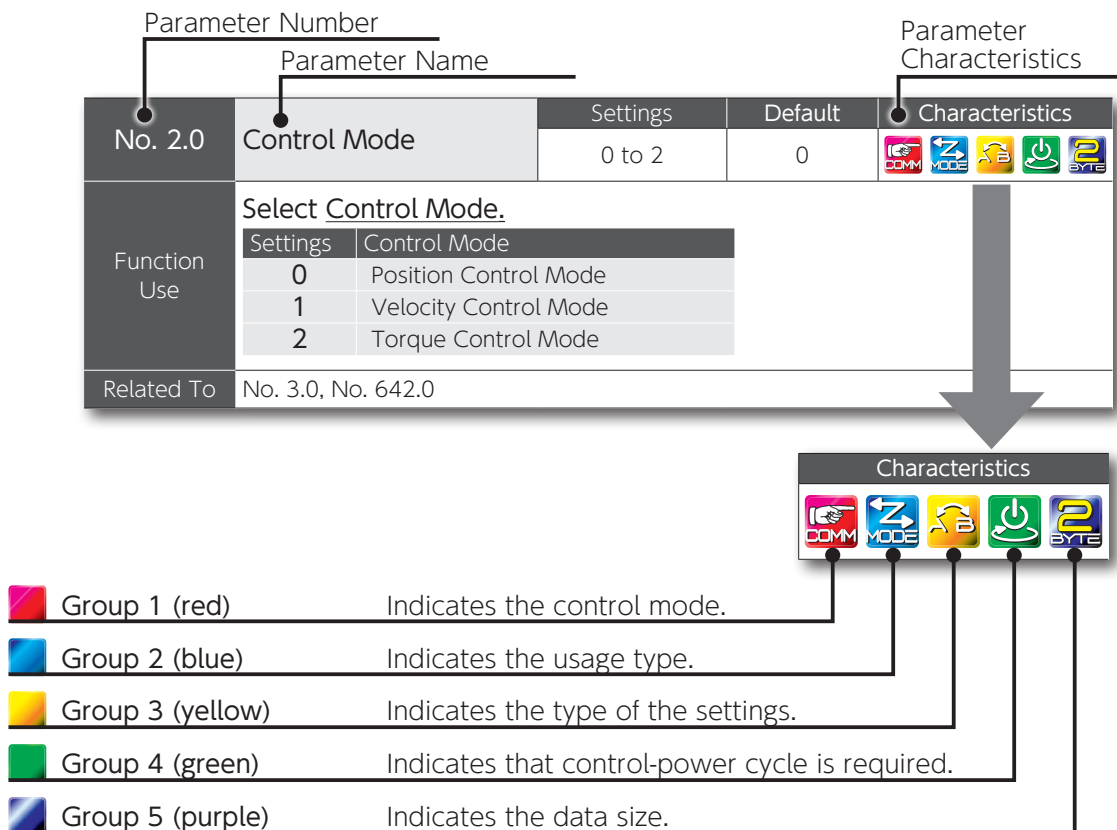

















Overview of the parameter list

(Two stacked parameters indicate a fraction.)



Characteristics of Parameters

The parameters are categorized into five groups according to their functions, uses, and features. The following icons are used to represent their characteristics.

| Group | Icon | Meaning |
|------------------|---|--|
| 1 (Red) |  | Common Used for all Control Modes |
| |  | Position Control Pulse Train Command Used for Pulse Train Command in Position Control Mode |
| |  | Position Control Internal Command Used for Internal Position Command in Position Control Mode |
| |  | Velocity Control Analog Command Used for Analog Command in Velocity Control Mode |
| |  | Velocity Control Internal Command Used for Internal Velocity Command in Velocity Control Mode |
| |  | Torque Control Analog Command Used for Analog Command in Torque Control Mode |
| 2 (Blue) |  | Communication Setup parameters for RS-485 Communication |
| |  | Operation Mode Used for selecting Control Mode, Command Mode, Operation Mode, Pulse Form and so forth. |
| |  | Operation Control Used to configure Pulse Ratio and Filters |
| |  | Alarm Detection Used for configuring Alarm Detection and Timing of Alarm Detection |
| |  | Tuning Gain parameters that require Tuning |
| |  | Homing Used for positioning operation in Position Control Mode |
| |  | Torque Limit Used for configuring Torque limit used in all Control Modes |
| |  | Deceleration Stop/ Emergency Stop/Quick Stop Used for configuring Stop processes in case of emergency or drive limit switch input active |
| |  | Vibration Control Parameters related to Vibration Control |
| 3 (Yellow) |  | Switch Parameters to enable or disable functions |
| |  | Selection Used for selecting conditions from multiple items based on your operational purposes |
| |  | Numeric Value Numeric values are set for these parameters, for example, pulse paired ratio or filter setup parameters. |
| 4 (Green) |  | Control Power Cycle Those parameters need power cycling for their setting changes to take effect. |
| 5 (Dark Blue) |  | 2-Byte Data 2-byte data  Communications Manual: RS-485 Communications |
| |  | 4-Byte Data 4-byte data  Communications Manual: RS-485 Communications |

1. Parameters

Common

Common

| Name | | No. | |
|---------------------------|----------------------|-----------|-------|
| Control mode | | 2.0 | 34 |
| Command mode | | 3.0 | 34 |
| Operation mode | | 9.0 | 35 |
| Warning latch time | | 12.0 | 36 |
| Alarm output timing | | 13.0 | 36 |
| Torque command limit | Switch | 144.0 | 62 |
| | Value 1 | 147.0 | 63 |
| | Value 2 | 148.0 | 63 |
| Torque limit output | | 144.1 | 63 |
| Servo OFF: Delay time | | 237.0 | 75 |
| Brake release: Delay time | | 238.0 | 75 |
| Absolute system | | 257.0 | 76 |
| Encoder pulse output | Rotational direction | 272.1 | 77 |
| | Command pulse ratio | Numerator | 276.0 |
| | Denominator | 278.0 | 78 |

JOG Operation

| Name | | No. | |
|-------------------|--|-------|----|
| Acceleration time | | 385.0 | 85 |
| Deceleration time | | 386.0 | 85 |
| Target speed | | 387.0 | 85 |

Warning/Error Detection

| Name | | No. | |
|---|-----------------------|-------|----|
| Position error Error detection | Switch | 65.0 | 41 |
| | Value | 87.0 | 51 |
| | Delay time | 89.0 | 51 |
| Position error Warning detection | Value | 363.0 | 85 |
| | Delay time | 365.0 | 85 |
| Speed error Error detection | Switch | 65.1 | 41 |
| | Value | 90.0 | 51 |
| | Delay time | 91.0 | 51 |
| Encoder pulse output Error detection | Frequency upper limit | 285.0 | 79 |
| | Delay time | 286.0 | 79 |
| Encoder Overheat detection | Switch | 259.0 | 76 |
| | Value | 267.0 | 77 |
| Encoder Battery Voltage drop detection | Switch | 259.1 | 76 |
| | Value | 268.0 | 77 |
| Voltage dip Detection | Delay time | 305.0 | 83 |

RS-485 Communications

| Name | | No. | |
|-----------------------|--|------|----|
| Switch | | 8.0 | 35 |
| Address | | 4.0 | 34 |
| Communication speed | | 6.0 | 34 |
| Stop bit | | 6.1 | 35 |
| Parity | | 6.2 | 35 |
| Minimum response time | | 11.0 | 35 |

Drive Limit Switch inputs

| Name | | No. | |
|----------------------------------|--|------|----|
| Setup | | 67.0 | 43 |
| Deceleration method | | 67.1 | 43 |
| Idling status | | 67.2 | 43 |
| Retaining position Error counter | | 67.3 | 43 |

Emergency Stop



| Name | | No. | |
|----------------|--------|-------|----|
| Warning output | Switch | 225.0 | 69 |
| | Timing | 225.1 | 69 |

Deceleration Stop



| Name | | No. | |
|------------------------------------|----------------------------|-------|----|
| Upon Servo Off | Method | 224.0 | 68 |
| | DBRK output after stopping | 224.3 | 69 |
| When alarm is on | Method | 233.0 | 73 |
| | DBRK output after stopping | 233.3 | 74 |
| Release conditions | | 224.1 | 68 |
| Operating time | | 226.0 | 70 |
| Cancellation speed | | 227.0 | 70 |
| Upon control power failure | Switch | 224.2 | 69 |
| | Operating time | 228.0 | 70 |
| Torque command limit | | 151.0 | 64 |
| Status during coast to stop | | 232.1 | 71 |
| Short brake operation after a stop | | 232.2 | 72 |
| Brake engagement | Timing | 232.3 | 72 |
| | Delay time | 234.0 | 74 |
| | Rotational speed | 235.0 | 74 |

Quick Stop



| Name | | No. | |
|-------------------|------------------------|-------|----|
| Smoothing filter | Switch | 225.2 | 69 |
| | Moving average counter | 229.0 | 71 |
| Extension Time | | 236.0 | 75 |
| Deceleration time | | 239.0 | 75 |

Position Command Filter



| Name | | No. | |
|----------|---------------------------------------|-------|----|
| Filter 1 | Selection | 66.0 | 42 |
| | Smoothing 1 Moving average counter | 80.0 | 48 |
| | Notch frequency | 74.0 | 46 |
| | Notch width | 75.0 | 46 |
| | High frequency gain | 76.0 | 46 |
| Filter 2 | Notch depth | 79.0 | 47 |
| | Selection | 82.0 | 49 |
| | Notch frequency | 83.0 | 49 |
| | Notch width | 84.0 | 50 |
| Filter 3 | High frequency gain | 85.0 | 50 |
| | Notch depth | 86.0 | 50 |
| | Selection | 82.1 | 49 |
| | Notch frequency | 357.0 | 84 |
| Filter 4 | Notch width | 358.0 | 84 |
| | High frequency gain | 359.0 | 84 |
| | Notch depth | 360.0 | 84 |
| Filter 4 | Selection | 66.1 | 42 |
| | Smoothing 2 Moving average counter | 81.0 | 48 |

Torque Command Filter



| Name | | No. | |
|-----------------|---------------|-------|----|
| Low-pass filter | Switch | 160.0 | 64 |
| | Auto setting | 160.2 | 65 |
| | Time constant | 162.0 | 65 |
| Notch filter | Switch | 160.1 | 64 |
| | Frequency | 168.0 | 66 |
| | Width | 169.0 | 66 |
| Notch filter 2 | Depth | 170.0 | 66 |
| | Switch | 160.3 | 65 |
| | Frequency | 171.0 | 67 |
| Notch filter 2 | Width | 172.0 | 67 |
| | Depth | 173.0 | 67 |

Position Control Mode

Pulse Train Command



| Name | No. | | |
|---------------------------------|---------------|------|----|
| Input pulse form | 32.0 | 36 | |
| Rotational direction | 32.1 | 37 | |
| Input logic | 32.3 | 37 | |
| Pulse ratio | Interpolation | 32.2 | 37 |
| | Numerator | 34.0 | 38 |
| | Denominator | 36.0 | 38 |
| Input filter | 33.0 | 37 | |
| Feed forward delay compensation | 66.3 | 42 | |

Positioning Complete



| Name | No. | | |
|----------------------|---------------|------|----|
| Determination method | 64.0 | 41 | |
| Detection criteria | Range | 68.0 | 44 |
| | Speed | 69.0 | 44 |
| | Command Input | 70.0 | 45 |
| Detection delay time | 71.0 | 45 | |

Internal Position



| Name | No. | | |
|---------------------------------|----------------------------|---------|----|
| Pulse ratio | Interpolation | 32.2 | 37 |
| | Numerator | 34.0 | 38 |
| | Denominator | 36.0 | 38 |
| Feed forward delay compensation | 66.3 | 42 | |
| Operation mode | 642.0 | 88 | |
| Overflow detection | 643.0 | 88 | |
| Point table | Point number Output method | 644.0 | 89 |
| | Motion of point No.0 | 646.3 | 92 |
| | Command method | 720.0 ~ | 96 |
| | Operation | 720.1 ~ | 96 |
| | Enable/Disable | 720.3 ~ | 96 |
| | Position | 722.0 ~ | 96 |
| | Rotational speed | 724.0 ~ | 97 |
| | Acceleration time | 726.0 ~ | 97 |
| | Deceleration time | 727.0 ~ | 97 |
| | Dwell time | 728.0 ~ | 97 |
| | Positioning completion | 729.0 ~ | 97 |

Homing



| Name | No. | | |
|--------------------------------------|--------|-------|----|
| Re-detection of home position sensor | 645.3 | 90 | |
| Direction | 646.0 | 91 | |
| Sensor polarity | 646.1 | 92 | |
| Timeout | Switch | 646.2 | 92 |
| | Time | 659.0 | 95 |
| Torque command limit | Switch | 647.0 | 93 |
| | Value | 656.0 | 95 |
| Time to detect press stopper | 655.0 | 95 | |
| Creep speed switch | 647.1 | 93 | |
| Rapid speed | 648.0 | 94 | |
| Creep speed | 649.0 | 94 | |
| Acceleration/Deceleration time | 650.0 | 94 | |
| Amount of home position shift | 651.0 | 94 | |
| Home position data | 653.0 | 95 | |
| Z-phase disabled distance | 657.0 | 95 | |
| Home reference signal selection | 645.0 | 89 | |
| Encoder Z-phase selection | 645.1 | 89 | |

Position Control Mode: Tuning



| Name | No. | | |
|---------------------------|------------------|-------|----|
| Inertia ratio | 102.0 | 52 | |
| Damping ratio | 103.0 | 52 | |
| Mode switch | 110.0 | 53 | |
| Tuning items | 110.1 | 53 | |
| Inertia ratio upper limit | 106.0 | 52 | |
| Control gain set | Automatic switch | 120.0 | 59 |
| | Upper Limit | 120.1 | 59 |
| | Tuning constant | 121.0 | 60 |
| Control gain set | 113.0 | 54 | |
| Inertia conditions | 113.1 | 55 | |
| Control level | 114.0 | 56 | |
| Control gain 1 | 115.0 | 57 | |
| Control gain 2 | 116.0 | 57 | |
| Gain FF compensation 1 | 117.0 | 58 | |
| Gain FF compensation 2 | 118.0 | 58 | |
| Integral gain | 119.0 | 59 | |
| Current control gain | 193.0 | 68 | |

Velocity Control Mode

Analog Velocity Command



| Name | | No. | | |
|----------------------|---------------------|-------------|------|----|
| Offset | Tuning method | 62.2 | 40 | |
| | value | 60.0 | 40 | |
| Rotational direction | | 62.0 | 40 | |
| Input filter | Switch | 62.1 | 40 | |
| | Numerator | 48.0 | 38 | |
| | Denominator | 49.0 | 38 | |
| Input gain | Numerator | 50.0 | 39 | |
| | Denominator | 51.0 | 39 | |
| Speed limit | CCW | Numerator | 52.0 | 39 |
| | | Denominator | 53.0 | 39 |
| | CW | Numerator | 54.0 | 39 |
| | | Denominator | 55.0 | 39 |
| Smoothing filter | Switch | 77.0 | 47 | |
| | Moving average time | 78.0 | 47 | |

Internal Velocity



| Name | | No. | |
|---------------------|---------------------|--------|----|
| Command method | | 388.0 | 86 |
| Acceleration time | | 390.0 | 86 |
| Deceleration time | | 391.0 | 86 |
| Target speed 1 to 8 | | 392.0~ | 87 |
| Smoothing filter | Switch | 77.0 | 47 |
| | Moving average time | 78.0 | 47 |

Velocity Control Mode: Tuning



| Name | | No. | |
|------------------------|-------------|-------|----|
| Inertia ratio | | 102.0 | 52 |
| Damping ratio | | 103.0 | 52 |
| Tuning | Mode switch | 110.0 | 53 |
| | Items | 110.1 | 53 |
| Control gain set | | 129.0 | 60 |
| Control level | | 130.0 | 61 |
| Control gain 1 | | 131.0 | 61 |
| Gain FF compensation 1 | | 132.0 | 62 |
| Integral gain | | 133.0 | 62 |
| Current control gain | | 193.0 | 68 |

Torque Control Mode

Analog Torque



| Name | | No. | | |
|-----------------------|---------------|-------------|-------|----|
| Offset | Tuning method | 302.2 | 83 | |
| | Value | 300.0 | 82 | |
| Direction of rotation | | 302.0 | 82 | |
| Input filter | Switch | 302.1 | 82 | |
| | Numerator | 288.0 | 80 | |
| | Denominator | 289.0 | 80 | |
| Input gain | Numerator | 290.0 | 80 | |
| | Denominator | 291.0 | 80 | |
| Torque limit | CCW | Numerator | 292.0 | 81 |
| | | Denominator | 293.0 | 81 |
| | CW | Numerator | 294.0 | 81 |
| | | Denominator | 295.0 | 81 |
| Speed Limit | | 152.0 | 64 | |





















Torque Control: Tuning



| Name | | No. | |
|------------------------|--|-------|----|
| Inertia ratio | | 102.0 | 52 |
| Damping ratio | | 103.0 | 52 |
| Control level | | 130.0 | 61 |
| Control gain 1 | | 131.0 | 61 |
| Gain FF compensation 1 | | 132.0 | 62 |
| Integral gain | | 133.0 | 62 |
| Current control gain | | 193.0 | 68 |













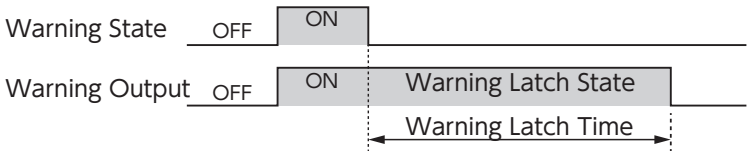

5. Parameters

2. Details of Parameters

| | | | | | |
|--------------|--|----------------------------|-------------|---|-----------|
| No. 2.0 | Control mode | Settings | Default | Characteristics | |
| | | 0 to 2 | 0 |      | |
| Function Use | <u>Select Control Mode</u> | | | | |
| | Settings | Control Mode | | | |
| | 0 | Position Control Mode | | | |
| | 1 | Velocity Control Mode | | | |
| | 2 | Torque Control Mode | | | |
| Related To | No. 3.0, No. 642.0 | | | | |
| No. 3.0 | Command mode | Settings | Default | Characteristics | |
| | | 0 to 3 | 1 |      | |
| Function Use | <u>Select Command Mode</u> | | | | |
| | Settings | Control Mode | 0: Position | 1: Velocity | 2: Torque |
| | 1: Pulse train command input | Yes | - | - | |
| | 2: Analog command | - | Yes | Yes | |
| | 3: Internal command | Yes | Yes | - | |
| Related To | No. 3.0, No. 642.0 | | | | |
| No. 4.0 | RS-485 communication: Address | Settings | Default | Characteristics | |
| | | 1 to 32 | 1 |      | |
| Function Use | Specify the address of the RS-485 communication. | | | | |
| Remark | Set this parameter to a unique address for each drive. | | | | |
| Related To | No. 6.0, No. 6.1, No. 6.2, No. 8.0, No. 11.0 | | | | |
| No. 6.0 | RS-485 communication: Communication speed | Settings | Default | Characteristics | |
| | | 0 to 5 | 5 |      | |
| Function Use | Specify the communications speed for the RS-485 communication. | | | | |
| | Settings | Communications Speed [bps] | | | |
| | 0 | 2,400 | | | |
| | 1 | 4,800 | | | |
| | 2 | 9,600 | | | |
| | 3 | 19,200 | | | |
| | 4 | 38,400 | | | |
| | 5 | 57,600 | | | |
| Related To | No. 4.0, No. 6.1, No. 6.2, No. 8.0, No. 11.0 | | | | |

| | | | | |
|--------------|--|-------------------------------------|---------------------------------------|---------------------|
| No. 6.1 | RS-485 communication: Stop bit | Settings 0, 1 | Default 0 | Characteristics |
| Function Use | Specify the stop bit of the RS-485 communication. | | | |
| | Settings | Stop bit | | |
| | 0 | 1-bit | | |
| | 1 | 2-bit | | |
| Related To | No. 4.0, No. 6.0, No. 6.2, No. 8.0, No. 11.0 | | | |
| No. 6.2 | RS-485 communication: Parity | Settings 0 to 2 | Default 0 | Characteristics |
| Function Use | Configure the parity of RS-485 communication. | | | |
| | Settings | Parity | | |
| | 0 | None | | |
| | 1 | Even | | |
| | 2 | Odd | | |
| Related To | No. 4.0, No. 6.0, No. 6.2, No. 8.0, No. 11.0 | | | |
| No. 8.0 | RS-485 communication: Enable Switch | Settings 0, 1 | Default 0 | Characteristics |
| Function Use | Enable/Disable RS-485 communication. | | | |
| | Settings | RS-485 communication | | |
| | 0 | Disable | | |
| | 1 | Enable | | |
| Remark | Select 0 if you are not using RS-485 communication. | | | |
| Related To | No. 4.0, No. 11.0 | | | |
| No. 9.0 | Operation mode | Settings 0, 1 | Default 0 | Characteristics |
| Function Use | Select I/O (CN1 connector) or Digitax SF Connect (communication) as I/O signal input source. Use this parameter to clear an alarm by using Digitax SF Connect | | | |
| | Settings | Input source I/O (CN1 Connector) | Digitax SF Connect (communication) | |
| | 0 | Enable | Disable | |
| | 1 | Disable | Enable | |
| Remark | This item will be back to the default when the control power turns off. You can set this item only with Digitax SF Connect, not with the Setup Panel. | | | |
| No. 11.0 | RS-485 communication: Minimum response time | Range 0 to 255 | Default 3 [ms] | Characteristics |
| Function Use | Use this item to adjust the response time from the drive to meet the communication specifications of the host control device. | | | |
| Related To | No. 4.0, No. 8.0 | | | |

5. Parameters















| No. 12.0 | Warning latch time | Range | Default | Characteristics | | | | | | | | |
|--|---|-------------|--------------|---|---|-------------------------------------|----------|--|---|--|--|--|
| | | 0 to 200 | 1 [50 ms] |    -  | | | | | | | | |
| Specify the length of latch time for warning output. | | | | | | | | | | | | |
| Function Use | <table border="1"> <thead> <tr> <th>Setting</th> <th>Description</th> </tr> </thead> <tbody> <tr> <td>0</td> <td>No limit</td> </tr> <tr> <td>1 to 200</td> <td>Latching Time = (Setting Value) × 50[ms]</td> </tr> </tbody> </table> | | Setting | Description | 0 | No limit | 1 to 200 | Latching Time = (Setting Value) × 50[ms] | | | | |
| | Setting | Description | | | | | | | | | | |
| 0 | No limit | | | | | | | | | | | |
| 1 to 200 | Latching Time = (Setting Value) × 50[ms] | | | | | | | | | | | |
| <p style="text-align: center;"><u>Warning Output time = Warning State time + Warning Latch time</u></p>  <p style="text-align: center;">Close RESET to release the alarm latch and turn the warning off.</p> | | | | | | | | | | | | |
| Related To | No. 225.0, No. 225.1 | | | | | | | | | | | |
| No. 13.0 | Alarm output timing | Settings | Default | Characteristics | | | | | | | | |
| | | 0, 1 | 0 |    -  | | | | | | | | |
| Specify when to output an alarm. | | | | | | | | | | | | |
| Function Use | <table border="1"> <thead> <tr> <th>Settings</th> <th>Output</th> </tr> </thead> <tbody> <tr> <td>0</td> <td>After the motor decelerates to stop</td> </tr> <tr> <td>1</td> <td>Immediately after an alarm occurs</td> </tr> </tbody> </table> | | Settings | Output | 0 | After the motor decelerates to stop | 1 | Immediately after an alarm occurs | | | | |
| | Settings | Output | | | | | | | | | | |
| 0 | After the motor decelerates to stop | | | | | | | | | | | |
| 1 | Immediately after an alarm occurs | | | | | | | | | | | |
| Remark | If Deceleration Stop: Method (when alarm is on) (No.233) = 0 (coast to stop), the alarm signal will be output regardless of this parameter setting. | | | | | | | | | | | |
| No. 32.0 | Pulse train command: Input pulse form | Settings | Default | Characteristics | | | | | | | | |
| | | 0 to 2 | 0 |      | | | | | | | | |
| Select the input signal form of Pulse Train Command. | | | | | | | | | | | | |
| Function Use | <table border="1"> <thead> <tr> <th>Settings</th> <th>Input Form</th> </tr> </thead> <tbody> <tr> <td>0</td> <td>Pulse and Direction</td> </tr> <tr> <td>1</td> <td>Quadrature phase difference pulse (A-Phase/ B-Phase)</td> </tr> <tr> <td>2</td> <td>Positive pulse and Negative pulse (CCW/CW)</td> </tr> </tbody> </table> | | Settings | Input Form | 0 | Pulse and Direction | 1 | Quadrature phase difference pulse (A-Phase/ B-Phase) | 2 | Positive pulse and Negative pulse (CCW/CW) | | |
| | Settings | Input Form | | | | | | | | | | |
| 0 | Pulse and Direction | | | | | | | | | | | |
| 1 | Quadrature phase difference pulse (A-Phase/ B-Phase) | | | | | | | | | | | |
| 2 | Positive pulse and Negative pulse (CCW/CW) | | | | | | | | | | | |
| Prerequisite | Position Control Mode | | | | | | | | | | | |
| Related To | No. 2.0, No. 3.0, No. 32.1, No. 32.3, No. 33.0, No. 642.0 | | | | | | | | | | | |

| | | | | |
|--------------|--|---|----------|-------------------------------|
| No. 32.1 | Pulse train command: Rotational direction | Settings | Default | Characteristics |
| | | 0, 1 | 1 | |
| Function Use | Specify the rotational direction of pulse train command. | | | |
| | Settings | Direction of Rotation | | |
| | 0 | CCW rotation if negative direction command | | |
| | 1 | CCW rotation if positive direction command | | |
| Related To | No. 2.0, No. 3.0, No. 32.1, No. 32.3, No. 33.0, No. 642.0 | | | |
| No. 32.2 | Pulse train command: Interpolation with pulse ratio | Settings | Default | Characteristics |
| | | 0, 1 | 1 | |
| Function Use | Enable/Disable the interpolation to smooth a command where Command Pulse Ratio is set. | | | |
| | Settings | Interpolation with pulse ratio | | |
| | 0 | Disable | | |
| | 1 | Enable | | |
| Related To | No. 32.0, No. 34.0, No. 36.0 | | | |
| No. 32.3 | Pulse train command: Input logic | Settings | Default | Characteristics |
| | | 0, 1 | 1 | |
| Function Use | Select a logic of how to input Pulse Train Command. | | | |
| | Settings | Input Logic | | |
| | 0 | Positive logic: Count at the time of rising edge (low to high) | | |
| | 1 | Negative logic: Count at the time of falling edge (high to low) | | |
| Remark | For pulse and direction, change the setting of this parameter will reverse the direction signal (DIR) logic. | | | |
| Related To | No. 32.0, No32.1 | | | |
| No. 33.0 | Pulse train command: Input filter | Settings | Default | Characteristics |
| | | 0 to 15 | 4 | |
| Function Use | It helps to reduce possibility of malfunctions caused by noise. This parameter has to be set when Pulse train command input is open collector. | | | |
| | Select a value according to pass-through pulse width (max frequency) of pulse train input. If a value selected did not eliminate the malfunction, select a higher value. | | | |
| | Settings | Pass-Through Pulse Width [ns] | Settings | Pass-Through Pulse Width [ns] |
| | 0 | No filter | 8 | 600 (500 kHz) |
| | 1 | 25 | 9 | 800 |
| | 2 | 50 (4 MHz) | 10 | 1,000 |
| | 3 | 100 | 11 | 1,200 |
| | 4 | 150 (2 MHz) | 12 | 1,600 (250 kHz) |
| | 5 | 200 | 13 | 2,000 |
| | 6 | 300 (1 MHz) | 14 | 2,300 |
| | 7 | 400 | 15 | 3,100 |
| Related To | No. 3.0, No. 32.0 | | | |

5. Parameters

| No. | Parameter Name | Range | Default | Characteristics | | | | | | | | | | | | | | |
|---------------------------------------|---|---------------|----------------------|-----------------|---|---|---------------|---------------------------------------|----------|----------|--------|---------------------------|-------|--------|-------|-------|-------|-------|
| No. 34.0 | Pulse train command: Ratio (numerator) | 1 to 65,535 | 1,000 [pulse/rev] | | | | | | | | | | | | | | | |
| No. 36.0 | Pulse train command: Ratio (denominator) | 1 to 65,535 | | | | | | | | | | | | | | | | |
| Function Use | <p>Use these two parameters to set the multiplier and divider for the position command pulse.</p> <p>When the pulse count per rotation of host command is not equal to its counterpart of motor, select one of the following for (numerator)/(denominator).</p> <p>(numerator) = (motor pulse count per rotation) /4=32,768 (denominator) = (host command pulse count per rotation) /4</p> $\frac{34.0}{36.0} = \frac{\text{motor pulse count per rotation}}{\text{host command pulse count per rotation}} = \frac{\text{motor pulse count per rotation} / 4}{\text{host command pulse count per rotation} / 4}$ | | | | | | | | | | | | | | | | | |
| | <p>Setting Example unit: [pulse/rev]</p> <table border="1"> <thead> <tr> <th>A</th> <th>B</th> <th>C (= A × 1/4)</th> </tr> <tr> <th>Host Command Pulse count per rotation</th> <th>No. 34.0</th> <th>No. 36.0</th> </tr> </thead> <tbody> <tr> <td>16,384</td> <td rowspan="4">32,768 (=131,072 (*) ÷ 4)</td> <td>4,096</td> </tr> <tr> <td>10,000</td> <td>2,500</td> </tr> <tr> <td>4,096</td> <td>1,024</td> </tr> <tr> <td>4,000</td> <td>1,000</td> </tr> </tbody> </table> <p>*) 131,072 is the pulse count per rotation of the motor. The default setting values are assumed 131072 pulses of the host command pulse number per a rotation.</p> | | | | A | B | C (= A × 1/4) | Host Command Pulse count per rotation | No. 34.0 | No. 36.0 | 16,384 | 32,768 (=131,072 (*) ÷ 4) | 4,096 | 10,000 | 2,500 | 4,096 | 1,024 | 4,000 |
| A | B | C (= A × 1/4) | | | | | | | | | | | | | | | | |
| Host Command Pulse count per rotation | No. 34.0 | No. 36.0 | | | | | | | | | | | | | | | | |
| 16,384 | 32,768 (=131,072 (*) ÷ 4) | 4,096 | | | | | | | | | | | | | | | | |
| 10,000 | | 2,500 | | | | | | | | | | | | | | | | |
| 4,096 | | 1,024 | | | | | | | | | | | | | | | | |
| 4,000 | | 1,000 | | | | | | | | | | | | | | | | |
| Remark | Range of Pulse Ratio (numerator/denominator) • Pulse train command: x0.001 to x1,000 • Internal Position Command: x1 to x1,000 | | | | | | | | | | | | | | | | | |
| Related To | No. 276.0, No. 278.0 | | | | | | | | | | | | | | | | | |





















| No. | Parameter Name | Range | Default | Characteristics | | | | | | | | | |
|--------------|---|------------------|---------|-----------------|---------|------------------|------------------|-------|--------|------|-------|------|------|
| No. 48.0 | Analog velocity: Input filter (numerator) | 0 to 65,535 | 16,000 | | | | | | | | | | |
| No. 49.0 | Analog velocity: Input filter (denominator) | 1 to 65,535 | 65,535 | | | | | | | | | | |
| Function Use | <p>These two parameters are used to configure a low-pass filter, which suppresses the noise component of analog velocity command input.</p> <table border="1"> <thead> <tr> <th>Setting</th> <th>Noise Resistance</th> <th>Command Response</th> </tr> </thead> <tbody> <tr> <td>small</td> <td>strong</td> <td>slow</td> </tr> <tr> <td>large</td> <td>weak</td> <td>fast</td> </tr> </tbody> </table> | | | | Setting | Noise Resistance | Command Response | small | strong | slow | large | weak | fast |
| Setting | Noise Resistance | Command Response | | | | | | | | | | | |
| small | strong | slow | | | | | | | | | | | |
| large | weak | fast | | | | | | | | | | | |
| Prerequisite | Analog Velocity: Input filter switch (No.62.1) = 1 (Enable) | | | | | | | | | | | | |
| Remark | The ratio of No.288.0 (numerator) to No.289.0 (denominator) must not be higher than 1. If the ratio = 1, filtering will not take effect. | | | | | | | | | | | | |
| Related To | No. 62.1 | | | | | | | | | | | | |

| No. | Parameter Name | Range | Default | Characteristics |
|---|---|-------------|--|---|
| No. 50.0 | Analog velocity: Input gain (numerator) | 0 to 65,535 | Maximum Rotational Speed of Motor |      |
| No. 51.0 | Analog velocity: Input gain (denominator) | 1 to 65,535 | | |
| Analog velocity command Input Gain. | | | | |
| Set the value of a rotational speed corresponding to input voltage. | | | | |
| When (numerator/denominator) = 1/2, a motor rotational speed is a half of maximum command input voltage (± 10 V). | | | | |
| The motor rotational speed is max (± 10 V) when (numerator/denominator) = 1. | | | | |
| By using this gain, you can adjust the position proportional gain of the host controller. | | | | |
| No. 52.0 | Analog velocity: CCW speed limit (numerator) | 0 to 65,535 | Maximum Rotational Speed of Motor |      |
| No. 53.0 | Analog velocity: CCW speed limit (denominator) | 1 to 65,535 | | |
| Analog velocity command: CCW speed limit. | | | | |
| $\text{CCW Speed Limit} = \text{Maximum rotational speed} \times \frac{\text{52.0}}{\text{53.0}}$ | | | | |
| No. 54.0 | Analog velocity: CW speed limit (numerator) | 0 to 65,535 | Maximum Rotational Speed of Motor |      |
| No. 55.0 | Analog velocity: CW speed limit (denominator) | 1 to 65,535 | | |
| Analog velocity command: CW speed limit. | | | | |
| $\text{CW Speed Limit} = \text{Maximum rotational speed} \times \frac{\text{54.0}}{\text{55.0}}$ | | | | |

Maximum Rotational Speed of Motor

| Motor Model | Maximum rotational speed [rpm] |
|---|-----------------------------------|
| MM500, MY500, MM101, MY101, MX201, MZ201, MX401, MZ401, MX751, MZ751, | 6,000 |
| MA201, MH201, MA401, MH401 | 5,000 |
| MA751, MH751 | 4,500 |
| MM102, MH102, MM152, MH152, MM202 | 3,000 |

5. Parameters

| | | | | |
|--------------|--|---|------------------------|---|
| No. 60.0 | Analog velocity: Offset value | Range | Default | Characteristics |
| | | - 32,768 to +32,767 | 0 |      |
| Function Use | Set the offset value when Analog velocity: offset tuning method (62.2) = 1 (manual). | | | |
| | <p>Connect power for the analog command, having the input voltage of 0 V, and adjust this parameter such that the rotational speed becomes 0 rpm.</p> <ol style="list-style-type: none"> For CCW rotations, set this parameter to a negative number, and for CW rotations, set to a positive number. If the actual rotational speed is beyond the ± 10 rpm range, set this parameter to ± 50 and check the motor motion. | | | |
| Prerequisite | Analog velocity: Offset tuning method (62.2) = 1 (manual) | | | |
| Related To | No. 62.2 | | | |
| No. 62.0 | Analog velocity: Rotational direction | Settings | Default | Characteristics |
| | | 0, 1 | 1 |      |
| Function Use | Select the rotational direction of analog speed pulse train input. | | | |
| | Settings | Negative Voltage Input | Positive Voltage Input | |
| | 0 | CCW Rotation | CW Rotation | |
| | 1 | CW Rotation | CCW Rotation | |
| No. 62.1 | Analog velocity: Input filter enable switch | Settings | Default | Characteristics |
| | | 0, 1 | 1 |      |
| Function Use | Enable/Disable Input filter for Analog Velocity Command. | | | |
| | This filter is a first-order IIR filter. Use it if there is too much noise in analog command. | | | |
| | Settings | Filter | | |
| | 0 | Disable | | |
| | 1 | Enable | | |
| No. 62.2 | Analog velocity: Offset tuning method | Settings | Default | Characteristics |
| | | 0, 1 | 1 |      |
| Function Use | Select either auto or manual method for offset tuning of Analog Velocity Command. | | | |
| | For manual adjustment, use the parameter Analog velocity: offset value (60.0) for tuning. | | | |
| | Settings | Offset tuning method | | |
| | 0 | Auto: Select this to automatically adjust the offset value, such that the speed command becomes 0 rpm with the input voltage at the time of servo on. | | |
| | 1 | Manual: Select this to manually adjust the offset value, such that the speed command becomes 0 rpm with 0V input voltage. | | |
| Related To | No. 60.0 | | | |

5. Parameters

| | | | | | | |
|--|---|--------------------------|-----------------------|--|--|--------------------|
| No. 64.0 | Positioning complete: Determination method | Settings | Default | Characteristics | | |
| | | 0, 1 | 0 | | | |
| Select one of two methods to output the Positioning Complete signal. | | | | | | |
| Function Use | | Signal Output Conditions | | | | |
| | | Settings | Position Error | Speed | Pulse Train command input | Parameter settings |
| | 0 | <input type="radio"/> | <input type="radio"/> | - | Detection criteria - Range (68.0) - Speed (69.0) | |
| 1 | <input type="radio"/> | <input type="radio"/> | <input type="radio"/> | Detection criteria - Range (68.0) - Speed (69.0) - command input (70.0) | | |
| Related To | No. 68.0, No. 69.0, No. 70.0, No. 71.0 | | | | | |

| | | | | | |
|--|--|----------|--------------------------|-----------------|--|
| No. 65.0 | Position error detection: Select switch | Settings | Default | Characteristics | |
| | | 0 to 3 | 1 | | |
| Specify what to output when excessive position error is detected. | | | | | |
| Function Use | | Settings | Output selection | | |
| | 0 | | No detect (No output) | | |
| | 1 | | Alarm output | | |
| | 2 | | Warning output | | |
| | 3 | | Alarm and Warning output | | |
| When using Torque command limit, select 0 (No output) so that an alarm will not occur in a torque limit state. | | | | | |
| Related To | No. 87.0, No. 89.0, No. 363.0, No. 365.0 | | | | |

| | | | | | |
|--|---|----------|-----------------------|-----------------|--|
| No. 65.1 | Speed error detection: Enable switch | Settings | Default | Characteristics | |
| | | 0, 1 | 1 | | |
| Enable/Disable Speed Error Detection. | | | | | |
| Function Use | | Settings | Speed error detection | | |
| | 0 | | Disable | | |
| | 1 | | Enable | | |
| When using Torque command limit, select "Disable" so that an alarm will not occur during limiting. | | | | | |
| Related To | No. 90.0, No. 91.0 | | | | |

5. Settings

5. Parameters

| | | | | |
|--------------|--|-------------|---------|-----------------|
| No. 66.0 | Position command filter 1: Select switch | Settings | Default | Characteristics |
| | | 0 to 3 | 0 | |
| Function Use | Select no filter or one of the three filters: | | | |
| | Settings | Filter Type | | |
| | 0 | None | | |
| | 1 | Smoothing 1 | | |
| | 2 | Notch | | |
| 3 | γ -Notch | | | |
| Remark | If you are to use Smoothing 1, try Filter 4 (Smoothing 2) first. | | | |
| Related To | No. 80.0, No. 74.0, No. 75.0, No. 76.0, No. 79.0 | | | |

7 Tuning

Up to four levels of Position command filter are available.

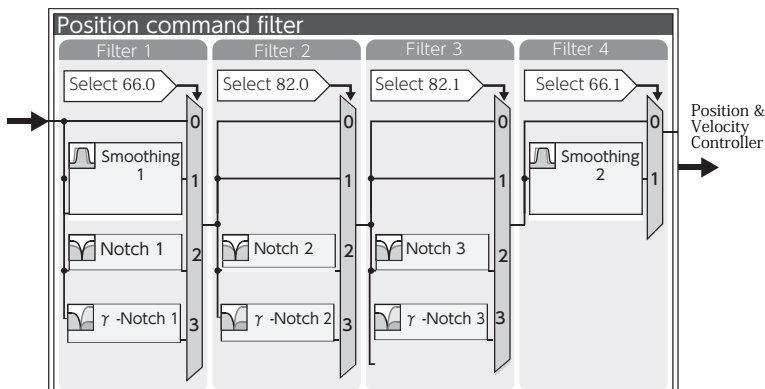





Block Diagram of Position Command Filter (Details)

| | | | | |
|--------------|--|----------|---------|-----------------|
| No. 66.1 | Position command filter 4: Enable Switch | Settings | Default | Characteristics |
| | | 0, 1 | 1 | |
| Function Use | Enable/Disable Position command Smoothing Filter 2 for Filter 4. | | | |
| | Settings | Filter | | |
| | 0 | Disable | | |
| 1 | Enable | | | |
| Remark | If you are to use Smoothing 1, try Filter 4 (Smoothing 2) first. | | | |
| Related To | No. 81.0 | | | |

7 Tuning

| | | | | |
|--------------|--|---------------------------------|---------|-----------------|
| No. 66.3 | Pulse train command: Feed forward delay compensation | Settings | Default | Characteristics |
| | | 0, 1 | 1 | |
| Function Use | Enable/Disable Feed Forward Delay Compensation in <u>Position Control Mode</u> . | | | |
| | Settings | Feed forward delay compensation | | |
| | 0 | Disable | | |
| 1 | Enable | | | |
| Remark | Usually, set 1 (enable) You can set this item only with Digitax SF Connect, not with the Setup Panel. | | | |

| | | | | |
|--------------|---|-----------------------------|------------------------------|--|
| No. 67.0 | Drive limit switch input: Setup | Settings 0 to 3 | Default 0 | Characteristics  |
| Function Use | By installing sensors at the ends of linear motion, you can restrict the drive within the motion range. | | | |
| | When "enable" is selected for this parameter, starting the motor will be blocked by I/O input ON. | | | |
| | Settings | CW Drive limit switch input | CCW Drive limit switch input | |
| | 0 | Disable | Disable | |
| | 1 | Enable | Disable | |
| | 2 | Disable | Enable | |
| | 3 | Enable | Enable | |
| Related To | No.67.1, No. 67.2, No. 67.3 | | | |
| No. 67.1 | Drive limit switch input: Deceleration method | Settings 0 to 2 | Default 1 | Characteristics  |
| No. 67.2 | Drive limit switch input: Idling status | Settings 0, 1 | Default 0 | Characteristics  |
| Function Use | Select the deceleration method upon drive limit switch input and specify the idling state after the motor stopped its motion. | | | |
| | Use one of the following four combinations. | | | |
| | Possible Combinations | Deceleration method (67.1) | Idling status (67.2) | |
| | 1 | 0: Coast to stop | 0: Coast to stop | |
| | 2 | 1: Short Brake | 1: Zero Clamp | |
| | 3 | 2: Quick Stop | 0: Coast to stop | |
| | 4 | | | |
| Prerequisite | Drive limit switch input: Setup (67.0) = 1, 2 or 3 (Enable) | | | |
| Related To | No.67.0, No. 67.3 | | | |
| No. 67.3 | Drive limit switch input: Retaining position error | Settings 0, 1 | Default 0 | Characteristics  |
| Function Use | counter Motor's stopping upon drive limit switch input results in position error from the input pulse. | | | |
| | Use this parameter to select either keep or clear that position error. | | | |
| | Settings | Position Error Counter | | |
| | 0 | Keep | | |
| | 1 | Clear | | |
| Related To | No.67.0, No.67.1, No. 67.2 | | | |

5. Parameters

| | | | | |
|----------|---|-------------|-----------------------|-----------------|
| No. 68.0 | Positioning complete: Detection criteria - Range | Range | Default | Characteristics |
| | | 0 to 32,767 | 40 [encoder pulse] | |

Function Use

Set the value for a pulse range (position error) to determine Positioning Complete.

When positioning is complete, the signal POSIN (positioning complete) will be output to the host controller.

Related To No. 64.0, No. 69.0, No. 70.0, No. 71.0

| | | | | |
|----------|---|-------------|-------------|-----------------|
| No. 69.0 | Positioning complete: Detection criteria - Speed | Range | Default | Characteristics |
| | | 0 to 32,767 | (See below) | |

Function Use

Set the upper limit for a speed to determine Positioning Complete.

| Motor Capacity | Default | Units | Conversion to Rotational Speed |
|----------------|---------|-------------------|--------------------------------|
| 50 W to 750 W | 2 | pulse/160 μ s | 5.72 [rpm] |
| 1 kW to 2 kW | 2 | pulse/200 μ s | 4.58 [rpm] |

When positioning is complete, the signal POSIN (positioning complete) will be output to the host controller.

Related To No. 64.0, No. 68.0, No. 70.0, No. 71.0

| No. 70.0 | Positioning complete: Detection criteria - Command Input | Range 0 to 32,767 | Default (See below) | Characteristics | | | | | | | | | | | |
|----------------|--|----------------------|--------------------------------|---------------------|----------------|---------|----------------------|--------------------------------|---------------|---|-------------------|---------|--------------|---|-------------------|
| | <p>Set the value for a pulse train command input (Speed) to determine Positioning Complete.</p> <table border="1"> <thead> <tr> <th>Motor Capacity</th> <th>Default</th> <th>units[encoder pulse]</th> <th>Conversion to Rotational Speed</th> </tr> </thead> <tbody> <tr> <td>50 W to 750 W</td> <td>0</td> <td>pulse/160 μs</td> <td>0 [rpm]</td> </tr> <tr> <td>1 kW to 2 kW</td> <td>0</td> <td>pulse/200 μs</td> <td>0 [rpm]</td> </tr> </tbody> </table> | | | | Motor Capacity | Default | units[encoder pulse] | Conversion to Rotational Speed | 50 W to 750 W | 0 | pulse/160 μ s | 0 [rpm] | 1 kW to 2 kW | 0 | pulse/200 μ s |
| Motor Capacity | Default | units[encoder pulse] | Conversion to Rotational Speed | | | | | | | | | | | | |
| 50 W to 750 W | 0 | pulse/160 μ s | 0 [rpm] | | | | | | | | | | | | |
| 1 kW to 2 kW | 0 | pulse/200 μ s | 0 [rpm] | | | | | | | | | | | | |
| Function Use | <p>When positioning is complete, the signal POSIN (positioning complete) will be output to the host controller.</p> | | | | | | | | | | | | | | |

| No. 71.0 | Positioning complete: Detection delay time | Range 0 to 65,000 | Default (See below) | Characteristics | | | | | | | | | | | |
|----------------|---|----------------------|------------------------|---------------------|----------------|---------|-------|--------------------|---------------|----|-------------|----------|--------------|----|-------------|
| | <p>Specify the delay time to output Positioning Complete signal (POSIN) to the host controller after Positioning Complete conditions are met.</p> <table border="1"> <thead> <tr> <th>Motor Capacity</th> <th>Default</th> <th>Units</th> <th>Conversion to Time</th> </tr> </thead> <tbody> <tr> <td>50 W to 750 W</td> <td>20</td> <td>160 μs</td> <td>3.2 [ms]</td> </tr> <tr> <td>1 kW to 2 kW</td> <td>16</td> <td>200 μs</td> <td>3.2 [ms]</td> </tr> </tbody> </table> | | | | Motor Capacity | Default | Units | Conversion to Time | 50 W to 750 W | 20 | 160 μ s | 3.2 [ms] | 1 kW to 2 kW | 16 | 200 μ s |
| Motor Capacity | Default | Units | Conversion to Time | | | | | | | | | | | | |
| 50 W to 750 W | 20 | 160 μ s | 3.2 [ms] | | | | | | | | | | | | |
| 1 kW to 2 kW | 16 | 200 μ s | 3.2 [ms] | | | | | | | | | | | | |
| Function Use | | | | | | | | | | | | | | | |
| Related To | No. 64.0, No. 68.0, No. 69.0, No. 70.0 | | | | | | | | | | | | | | |

5. Parameters

| | | | | |
|--------------|--|-------------|----------------|-----------------|
| No. 74.0 | Position command filter 1: Notch frequency | Range | Default | Characteristics |
| | | 10 to 2,000 | 10 [0.1 Hz] | |
| Function Use | Set the <u>notch frequency</u> for Position command filter 1. | | | |
| Prerequisite | Position command filter 1: Type (66.0) = 2 (Notch) or 3 (γ -Notch) | | | |
| Related To | No. 66.0, No. 75.0, No. 76.0, No. 79.0 | | | |

7 Tuning

| | | | | |
|--------------|---|--------------|---------|-----------------|
| No. 75.0 | Position command filter 1: Notch width | Range | Default | Characteristics |
| | | 128 to 2,048 | 512 | |
| Function Use | Set the <u>width of notch</u> of Position Command Filter 1. | | | |
| | Setting | Notch Width | | |
| | smaller | narrower | | |
| | larger | wider | | |
| Prerequisite | Position command filter 1: Type (66.0) = 2 (Notch) | | | |
| Related To | No. 66.0, No. 74.0, No. 79.0 | | | |

7 Tuning

| | | | | |
|--------------|--|-----------|---------|-----------------|
| No. 76.0 | Position command filter 1: High frequency gain | Range | Default | Characteristics |
| | | 50 to 200 | 100 | |
| Function Use | Set the <u>high frequency gain</u> of Position Command Filter1. | | | |
| | Setting | Effect | | |
| | 50 | x0.25 | | |
| | 100 | x1 | | |
| | 200 | x4 | | |
| | Smaller setting value gives better vibration suppression. Larger setting value gives faster motion. | | | |
| Prerequisite | Position command filter 1: Type (66.0) = 3 (γ -Notch). | | | |
| Related To | No. 66.0, No. 74.0, No. 79.0 | | | |

7 Tuning

| | | | | |
|--------------|---|---|----------|-----------------|
| No. 77.0 | Velocity command: Smoothing filter - Enable Switch | Settings | Default | Characteristics |
| | | 0, 1 | 512 | |
| Function Use | Enable/Disable Speed Command Smoothing Filter in <u>Velocity Control Mode</u> . | | | |
| | This function enables the user to smooth the motion during high deceleration/acceleration from Speed Command. In addition, this smoothing filter can be used as a countermeasure against noise in Analog Velocity Command Mode. | | | |
| | Settings | Filter | | |
| | 0 | Disable | | |
| | 1 | Enable | | |
| Related To | No. 78.0 | | | |
| No. 78.0 | Velocity command: Smoothing filter - Moving average time | Range | Default | Characteristics |
| | | 1 to 1,000 | 100 [ms] | |
| Function Use | Set the value for Speed Command Smoothing Filter-Moving Average Time in <u>Velocity Control Mode</u> . however, this will result in a delayed response. | | | |
| Prerequisite | Velocity command: Smoothing filter switch (77.0) = 1 (Enable) | | | |
| Related To | No. 77.0 | | | |
| No. 79.0 | Position command filter 1: Notch depth | Range | Default | Characteristics |
| | | 0 to 100 | 0 | |
| Function Use | Set the notch depth of Position command filter 1. | | | |
| | Setting | Notch Depth | | |
| | 0 | complete shutoff of notch frequency input | | |
| | 100 | 100 % pass-through | | |
| | Smaller setting value gives deeper filter. Larger setting value gives shallower filter. | | | |
| Prerequisite | Position command filter 1: Type (66.0) = 2 (Notch) or 3 (γ -Notch) | | | |
| Related To | No. 66.0, No. 74.0, No. 75.0, No. 76.0 | | | |

5. Parameters

| No. | Parameter Name | Range | Default | Characteristics | | | | | | | | | | | | | | | | | | | | | |
|----------------|---|---|-------------|---|----------------|--------------------------------|---------------|---------|--------------|--------|----------------|---|---------------|-------|--------------|-------|----------------|----------|----------|---------------|----|----|--------------|----|----|
| No. 80.0 | Position command filter 1: Smoothing 1 - Moving average counter | 1 to 6,250 | (See below) |  | | | | | | | | | | | | | | | | | | | | | |
| No. 81.0 | Position command filter 4: Smoothing 2 - Moving average counter | 1 to 1,250 | | | | | | | | | | | | | | | | | | | | | | | |
| Function Use | <p>These items are used to smooth the speed changes during high deceleration/acceleration, and can be used to suppress vibrations at settling time as well.</p> <p><u>Use Filter 4 (Smoothing 2) first.</u> To increase the smoothing effect further, use Filter 1 (Smoothing 1).</p> <p>A larger value makes acceleration and deceleration smoother, but the response will become slower. See the table below for the delay time calculation formula. Filter 4 (Smoothing 2) suppress the vibrations caused by the Gain FF compensation 2.</p> <table border="1"> <thead> <tr> <th>Motor Capacity</th> <th>Delay time Calculation Formula</th> </tr> </thead> <tbody> <tr> <td>50 W to 750 W</td> <td>0.16 ms</td> </tr> <tr> <td>1 kW to 2 kW</td> <td>0.2 ms</td> </tr> </tbody> </table> <p>■ Setup of Vibration Suppression Positioning will take longer as much as the delay time specified above. Set this item within the range acceptable to the equipment.</p> <ol style="list-style-type: none"> Check the vibration interval in waveforms of position error and torque command at settling time. Calculate the moving average count as described below. Using Filter 4 may reduce the resonant vibrations. If suppression of the vibrations is not effective enough, recalculate the moving average count based on the vibration interval, and set it to Filter 1. <table border="1"> <thead> <tr> <th>Motor Capacity</th> <th>Moving average count and Vibration interval to compress</th> </tr> </thead> <tbody> <tr> <td>50 W to 750 W</td> <td>6,250</td> </tr> <tr> <td>1 kW to 2 kW</td> <td>5,000</td> </tr> </tbody> </table> <p>$\times (\text{vibration interval [s]}) = \text{Moving average count}$</p> <p>Default</p> <table border="1"> <thead> <tr> <th>Motor Capacity</th> <th>Filter 1</th> <th>Filter 4</th> </tr> </thead> <tbody> <tr> <td>50 W to 750 W</td> <td>25</td> <td>10</td> </tr> <tr> <td>1 kW to 2 kW</td> <td>20</td> <td>10</td> </tr> </tbody> </table> <p>The default value of Position command filter 1: Type (66.0) is 0 (no filter).</p> | | | | Motor Capacity | Delay time Calculation Formula | 50 W to 750 W | 0.16 ms | 1 kW to 2 kW | 0.2 ms | Motor Capacity | Moving average count and Vibration interval to compress | 50 W to 750 W | 6,250 | 1 kW to 2 kW | 5,000 | Motor Capacity | Filter 1 | Filter 4 | 50 W to 750 W | 25 | 10 | 1 kW to 2 kW | 20 | 10 |
| | Motor Capacity | Delay time Calculation Formula | | | | | | | | | | | | | | | | | | | | | | | |
| | 50 W to 750 W | 0.16 ms | | | | | | | | | | | | | | | | | | | | | | | |
| | 1 kW to 2 kW | 0.2 ms | | | | | | | | | | | | | | | | | | | | | | | |
| | Motor Capacity | Moving average count and Vibration interval to compress | | | | | | | | | | | | | | | | | | | | | | | |
| | 50 W to 750 W | 6,250 | | | | | | | | | | | | | | | | | | | | | | | |
| 1 kW to 2 kW | 5,000 | | | | | | | | | | | | | | | | | | | | | | | | |
| Motor Capacity | Filter 1 | Filter 4 | | | | | | | | | | | | | | | | | | | | | | | |
| 50 W to 750 W | 25 | 10 | | | | | | | | | | | | | | | | | | | | | | | |
| 1 kW to 2 kW | 20 | 10 | | | | | | | | | | | | | | | | | | | | | | | |
| Prerequisite | Position command filter 1: Selection (66.0) = 1 (Smoothing 1) Position command filter 4: Selection (66.1) = 1 (Enable) | | | | | | | | | | | | | | | | | | | | | | | | |
| Remark | Before setting this parameter, wait at least 3 secs after the motor stops. In addition, configure it when the command pulse is not present. Setting this parameter during pulse input or presence of residual pulse could cause positioning failure. The larger the setting is, the longer the delay time from command input will be. | | | | | | | | | | | | | | | | | | | | | | | | |
| Related To | No. 66.0, No. 66.1 | | | | | | | | | | | | | | | | | | | | | | | | |

| | | | | |
|--------------|---|-----------------------|---------|-----------------|
| No. 82.0 | Position command filter 2: Selection | Settings | Default | Characteristics |
| | | 0 to 3 | 0 | |
| Function Use | Set the Position Command Filter 2. | | | |
| | Settings | Filter Type | | |
| | 0 | None | | |
| | 1 | Reserved (Do not use) | | |
| | 2 | Notch | | |
| | 3 | γ -Notch | | |
| Related To | No. 83.0, No. 84.0, No. 85.0, No. 86.0 | | | |

















| | | | | |
|--------------|--|-----------------------|---------|-----------------|
| No. 82.1 | Position command filter 3: Selection | Settings | Default | Characteristics |
| | | 0 to 3 | 0 | |
| Function Use | Set Position Command Filter 3. | | | |
| | Settings | Filter Type | | |
| | 0 | None | | |
| | 1 | Reserved (Do not use) | | |
| | 2 | Notch | | |
| | 3 | γ -Notch | | |
| Related To | No. 357.0, No. 358.0, No. 359.0, No. 360.0 | | | |



| | | | | |
|--------------|--|-------------|---------------|-----------------|
| No. 83.0 | Position command filter 2: Notch frequency | Range | Default | Characteristics |
| | | 10 to 2,000 | 10 [0.1Hz] | |
| Function Use | Set the <u>notch frequency</u> for Position command filter 2. | | | |
| Prerequisite | Position command filter 2: Select (82.0) = 2 (Notch) or 3 (γ -Notch) | | | |
| Related To | No. 82.0, No. 84.0, No. 85.0, No. 86.0 | | | |



5. Parameters

| | | | | |
|--------------|--|---|---------|---|
| No. 84.0 | Position command filter 2: Notch width | Range | Default | Characteristics |
| | | 128 to 2,048 | 512 |      |
| Function Use | Set the <u>notch width</u> of Position Command Filter 2. | | | |
| | Setting | Notch Width | | |
| | smaller | narrower | | |
| | larger | wider | | |
| Prerequisite | Position command filter 2: Select (82.0) = 2 (Notch) | | | |
| Related To | No. 82.0, No. 83.0, No. 85.0, No. 86.0 | | | |
| No. 85.0 | Position command filter 2: High frequency gain | Range | Default | Characteristics |
| | | 50 to 200 | 100 |      |
| Function Use | Set the <u>high frequency gain</u> for Position Command Filter 2. | | | |
| | Setting | Effect | | |
| | 50 | x0.25 | | |
| | 100 | x1 | | |
| | 200 | x4 | | |
| | Smaller setting value gives better vibration suppression. Larger setting value gives faster motion. | | | |
| Prerequisite | Position command filter 2: Type (82.0) = 3 (γ -Notch) | | | |
| Related To | No. 82.0, No. 83.0, No. 86.0 | | | |
| No. 86.0 | Position command filter 2: Notch depth | Range | Default | Characteristics |
| | | 0 to 100 | 0 |      |
| Function Use | Specify the <u>notch depth</u> of Position Command Filter2. | | | |
| | Setting | Effect | | |
| | 0 | complete shutoff of notch frequency input | | |
| | 100 | 100 % pass-through | | |
| | Smaller setting value gives deeper filter. Larger setting value gives shallower filter. | | | |
| Prerequisite | Position command filter 2: Select (82.0) = 2 (Notch) or 3 (γ -Notch) | | | |
| Related To | No. 82.0, No. 83.0, No. 84.0, No. 85.0 | | | |

| No. | Position error detection: Value | Range | Default | Characteristics | | | | | | | | |
|----------------|---|--------------------|----------------------------|-----------------|----------------|---------|-------------------|---------------|----------------------------|-------------|--------------|----------------------------|
| No. 87.0 | | 0 to 2,147,483,647 | 196,608 [encoder pulse] | | | | | | | | | |
| Function Use | <p>This parameter sets a threshold value for a position error detection.</p> <p>The higher the value, the less likely to detect position error. (The initial value of 196,608 is equivalent to pulse count of rotor 1.5 rotations.)</p> | | | | | | | | | | | |
| Prerequisite | Position error detection: Switch (65.0) = 1 (Enable) | | | | | | | | | | | |
| Related To | No. 65.0, No. 89.0 | | | | | | | | | | | |
| No. | Position error detection: Delay time | Range | Default | Characteristics | | | | | | | | |
| No. 89.0 | | 0 to 32,767 | (See below) | | | | | | | | | |
| Function Use | <p>This parameter sets a delay time for a position error (Alarm No.6) to be output after the position error exceeded the setting of [Position error detection value (87.0)]</p> <p>The higher the value, the longer it takes for the error to be output.</p> <table border="1"> <thead> <tr> <th>Motor Capacity</th> <th>Default</th> <th>Converted to Time</th> </tr> </thead> <tbody> <tr> <td>50 W to 750 W</td> <td>250 [160 μs]</td> <td rowspan="2">40 [ms]</td> </tr> <tr> <td>1 kW to 2 kW</td> <td>200 [200 μs]</td> </tr> </tbody> </table> | | | | Motor Capacity | Default | Converted to Time | 50 W to 750 W | 250 [160 μs] | 40 [ms] | 1 kW to 2 kW | 200 [200 μs] |
| Motor Capacity | Default | Converted to Time | | | | | | | | | | |
| 50 W to 750 W | 250 [160 μs] | 40 [ms] | | | | | | | | | | |
| 1 kW to 2 kW | 200 [200 μs] | | | | | | | | | | | |
| Prerequisite | Position error detection: Switch (65.0) = 1 (Enable) | | | | | | | | | | | |
| Related To | No. 65.0, No. 87.0 | | | | | | | | | | | |
| No. | Speed error detection: Value | Range | Default | Characteristics | | | | | | | | |
| No. 90.0 | | 0 to 32,767 | (See below) | | | | | | | | | |
| Function Use | <p>This parameter sets a threshold value for a speed error detection.</p> <p>The higher the value, the less likely to detect a speed error.</p> <table border="1"> <thead> <tr> <th>Motor Capacity</th> <th>Default</th> <th>Speed Conversion</th> </tr> </thead> <tbody> <tr> <td>50 W to 750 W</td> <td>524 [encoder pulse/160 μs]</td> <td rowspan="2">1,499 [rpm]</td> </tr> <tr> <td>1 kW to 2 kW</td> <td>655 [encoder pulse/200 μs]</td> </tr> </tbody> </table> | | | | Motor Capacity | Default | Speed Conversion | 50 W to 750 W | 524 [encoder pulse/160 μs] | 1,499 [rpm] | 1 kW to 2 kW | 655 [encoder pulse/200 μs] |
| Motor Capacity | Default | Speed Conversion | | | | | | | | | | |
| 50 W to 750 W | 524 [encoder pulse/160 μs] | 1,499 [rpm] | | | | | | | | | | |
| 1 kW to 2 kW | 655 [encoder pulse/200 μs] | | | | | | | | | | | |
| Prerequisite | Speed error detection - Switch (65.1) = 1 (Enable) | | | | | | | | | | | |
| Related To | No. 65.1, No. 91.0 | | | | | | | | | | | |
| No. | Speed error detection: Delay time | Range | Default | Characteristics | | | | | | | | |
| No. 91.0 | | 0 to 32,767 | (See below) | | | | | | | | | |
| Function Use | <p>This parameter sets a delay time for a speed error (Alarm No.5) to be detected after the speed error exceeded the setting of "Speed error - Detection value" (90.0).</p> <p>The higher the value, the longer the error detection time.</p> <table border="1"> <thead> <tr> <th>Motor Capacity</th> <th>Default</th> <th>Converted to Time</th> </tr> </thead> <tbody> <tr> <td>50 W to 750 W</td> <td>250 [160 μs]</td> <td rowspan="2">40 [ms]</td> </tr> <tr> <td>1 kW to 2 kW</td> <td>200 [200 μs]</td> </tr> </tbody> </table> | | | | Motor Capacity | Default | Converted to Time | 50 W to 750 W | 250 [160 μs] | 40 [ms] | 1 kW to 2 kW | 200 [200 μs] |
| Motor Capacity | Default | Converted to Time | | | | | | | | | | |
| 50 W to 750 W | 250 [160 μs] | 40 [ms] | | | | | | | | | | |
| 1 kW to 2 kW | 200 [200 μs] | | | | | | | | | | | |
| Prerequisite | Speed error detection - Switch (65.1) = 1 (Enable) | | | | | | | | | | | |
| Related To | No. 65.1, No. 90.0 | | | | | | | | | | | |

5. Parameters

| No. 102.0 | Tuning: Inertia ratio | Range | Default | Characteristics |
|--------------|---|---------------|---------|-----------------|
| | | 100 to 10,000 | 250 [%] | |
| Function Use | Specify the ratio of the device load inertia to motor rotor inertia (moment of inertia). | | | |
| | $\text{Inertia Ratio} = \frac{(\text{Load Inertia}) + (\text{Rotor Inertia})}{(\text{Rotor Inertia})} \times 100 \text{ [%]}$ | | | |
| | Inertia ratio is estimated by auto-tuning. When estimation is difficult (for example, too large an inertia ratio or too large a torque value), you can enter a calculated value of load inertia. If vibration occurs after deceleration or acceleration, increase the inertia ratio. | | | |
| Remark | The inertia ratio being too large or too small will cause noise. | | | |

7 Tuning

| No. 103.0 | Tuning: Damping ratio | Range | Default | Characteristics |
|--------------|---|--------------|---------|-----------------|
| | | 100 to 5,000 | 100 [%] | |
| Function Use | This parameter can be used for tuning to improve poor settling due to viscous friction, or too large an inertia ratio. | | | |
| | Increasing (or decreasing) this parameter value in event of overshoot (or undershoot respectively) may make the settling time shorter. The value of this parameter is estimated along with inertia ratio simultaneously if Tuning: Mode switching (110.1) = 2. | | | |
| Prerequisite | Position Control Mode, Velocity Control Mode | | | |
| Related To | No. 110.1 | | | |

| No. 106.0 | Tuning: Inertia ratio upper limit | Range | Default | Characteristics |
|--------------|--|---------------|-----------|-----------------|
| | | 100 to 10,000 | 3,000 [%] | |
| Function Use | Set the upper limit of the inertia ratio automatically adjusted in Quick Tuning. | | | |
| Prerequisite | Tuning: Control gain set - Automatic switch (120.0) : 1 (Enable) | | | |
| Related To | No. 110.1, No. 120.0 | | | |

| | | | | | |
|--|--|-------------|---|---------|-----------------|
| No. 110.0 | Tuning: Mode switch | | Settings | Default | Characteristics |
| | | | 1, 2 | 2 | |
| Function Use | Select a tuning condition depending on the direction of load or the presence of unbalanced load. | | | | |
| | Settings | Mode | Motion direction of the device connected to the motor | | |
| | 1 | Standard | Horizontal axis force | | |
| | 2 | Offset Load | Non-horizontal axis force | | |
| Use Offset Load Mode even for the case of axis force (horizontal motion) | | | | | |
| Prerequisite | Position Control Mode, Velocity Control Mode | | | | |

7 Tuning

| | | | | | |
|--------------|--|----------------|---------------|---------|-----------------|
| No. 110.1 | Tuning: Items | | Settings | Default | Characteristics |
| | | | 0 to 2 | 0 | |
| Function Use | Select Start or Stop for tuning depending on your choice of items to be estimated. | | | | |
| | Settings (Tuning) | Estimate items | | | |
| | | Inertia ratio | Damping ratio | | |
| | 0 (stop) | no estimate | no estimate | | |
| | 1 (start) | estimate | estimate | | |
| 2 (start) | estimate | | | | |
| Prerequisite | Position Control Mode, Velocity Control Mode | | | | |

7 Tuning

5. Parameters

| No. 113.0 | Tuning: Position control mode - Control gain set | Range 5 to 45 | Default 15 | Characteristics  | | | | | | | | | | | | | | | | | | | | | | | | | |
|--------------|--|------------------|---------------|--|---------|------------------|----------|---------------|----------------------|---|--------|-------|--------|-------|---|---|---|---|---|---|---|---|---|---|----|--------|--------|---------|--------|
| Function Use | <p>Select one control gain set for <u>Position Control Mode</u>.</p> <p>Control Gain 1 (115.0), Control Gain 2 (116.0), and Integral Gain (119.0) are set to the preset values of pairs.</p> <p><u>Noise Solutions</u></p> <ol style="list-style-type: none"> ① Use Torque command filter: Notch filter (such as 160.1). ② Decrease the value of Integral Gain (119.0). ③ Decrease the value of Control Gain 2 (116.0). <p>If the above does not work, lower the Control Gain Set.</p> <table border="1" data-bbox="387 786 1412 965"> <thead> <tr> <th>Setting</th> <th>Command Response</th> <th>Rigidity</th> <th>Settling Time</th> <th>Possibility of Noise</th> </tr> </thead> <tbody> <tr> <td>5</td> <td>slower</td> <td>lower</td> <td>longer</td> <td>lower</td> </tr> <tr> <td>↑</td> <td>↑</td> <td>↑</td> <td>↑</td> <td>↑</td> </tr> <tr> <td>↓</td> <td>↓</td> <td>↓</td> <td>↓</td> <td>↓</td> </tr> <tr> <td>45</td> <td>faster</td> <td>higher</td> <td>shorter</td> <td>higher</td> </tr> </tbody> </table> | | | | Setting | Command Response | Rigidity | Settling Time | Possibility of Noise | 5 | slower | lower | longer | lower | ↑ | ↑ | ↑ | ↑ | ↑ | ↓ | ↓ | ↓ | ↓ | ↓ | 45 | faster | higher | shorter | higher |
| Setting | Command Response | Rigidity | Settling Time | Possibility of Noise | | | | | | | | | | | | | | | | | | | | | | | | | |
| 5 | slower | lower | longer | lower | | | | | | | | | | | | | | | | | | | | | | | | | |
| ↑ | ↑ | ↑ | ↑ | ↑ | | | | | | | | | | | | | | | | | | | | | | | | | |
| ↓ | ↓ | ↓ | ↓ | ↓ | | | | | | | | | | | | | | | | | | | | | | | | | |
| 45 | faster | higher | shorter | higher | | | | | | | | | | | | | | | | | | | | | | | | | |
| Prerequisite | Position Control Mode | | | | | | | | | | | | | | | | | | | | | | | | | | | | |
| Remark | <ul style="list-style-type: none"> • Too large a value in this parameter may cause noise. • The default value varies depending on the setting of Position Control Mode - Inertia conditions (113.1). • If Torque command filter: Low-pass filter - Auto setting (160.2) = 1 (auto setting ON), then Torque command filter: Low-pass filter - Time constant (162.0) will be included in the gain set. | | | | | | | | | | | | | | | | | | | | | | | | | | | | |
| Related To | No. 113.1, No. 114.0, No. 115.0, No. 116.0, No. 117.0, No. 118.0, No. 119.0, No. 162.0 | | | | | | | | | | | | | | | | | | | | | | | | | | | | |



Tuning

| No. 113.1 | Tuning: Position control mode - Inertia conditions | Settings | Default | Characteristics |
|-----------------|---|--|---|---|
| | | 0 to 3 | 2 |  |
| Function Use | Set the inertia conditions for <u>Position Control Mode</u> . | | | |
| | This parameter is used to determine the ratio of Control Gain 1 (115.0) to Control Gain 2 (116.0), which would be appropriate to equipment characteristics. | | | |
| | | Settings | Description | |
| | | 1 | Heavy-load equipment or equipment with substantial load fluctuation Equipment with low rigidity, robot arms, and so on | |
| | 2 | (medium setting) For example, general transport machines | | |
| | 3 | Light-load equipment Equipment that demands high-speed operation or requires settling | | |
| Prerequisite | Position Control Mode | | | |
| Related To | No. 113.0, No. 115.0, No. 116.0 | | | |

 7 Tuning

5. Parameters

| No. 114.0 | Tuning: Position control mode - Control level | Range | Default | Characteristics | | | | | | | | | | | | | | | | | | | | | | | | | |
|--------------|--|------------------|----------|---|----------------------|------------------|----------|---------------|----------------------|---|--------|-------|--------|-------|---|---|---|---|---|---|---|---|---|---|----|--------|--------|---------|--------|
| | | 5 to 45 | 15 |  | | | | | | | | | | | | | | | | | | | | | | | | | |
| Function Use | <p>Set the Control Level of <u>Position Control Mode</u>.</p> <p>With this parameter, both Control Gain 1 (115.0) and Control Gain 2 (116.0) can be set to pairs of preset values. In Digitax SF Connect, set this parameter under the [Waveform Monitor] tab.</p> <p><u>Noise Solutions</u></p> <ol style="list-style-type: none"> ① Use Torque command filter: Notch filter (such as 160.1). ② Decrease Position control mode - Integral gain (119.0). ③ Decrease Position control mode - Control gain 2 (116.0). <p>If any of the above does not work, decrease the Control Gain Set value.</p> <table border="1"> <thead> <tr> <th>Setting</th> <th>Command Response</th> <th>Rigidity</th> <th>Settling Time</th> <th>Possibility of Noise</th> </tr> </thead> <tbody> <tr> <td>5</td> <td>slower</td> <td>lower</td> <td>longer</td> <td>lower</td> </tr> <tr> <td>↑</td> <td>↑</td> <td>↑</td> <td>↑</td> <td>↑</td> </tr> <tr> <td>↓</td> <td>↓</td> <td>↓</td> <td>↓</td> <td>↓</td> </tr> <tr> <td>45</td> <td>faster</td> <td>higher</td> <td>shorter</td> <td>higher</td> </tr> </tbody> </table> | | | | Setting | Command Response | Rigidity | Settling Time | Possibility of Noise | 5 | slower | lower | longer | lower | ↑ | ↑ | ↑ | ↑ | ↑ | ↓ | ↓ | ↓ | ↓ | ↓ | 45 | faster | higher | shorter | higher |
| | Setting | Command Response | Rigidity | Settling Time | Possibility of Noise | | | | | | | | | | | | | | | | | | | | | | | | |
| 5 | slower | lower | longer | lower | | | | | | | | | | | | | | | | | | | | | | | | | |
| ↑ | ↑ | ↑ | ↑ | ↑ | | | | | | | | | | | | | | | | | | | | | | | | | |
| ↓ | ↓ | ↓ | ↓ | ↓ | | | | | | | | | | | | | | | | | | | | | | | | | |
| 45 | faster | higher | shorter | higher | | | | | | | | | | | | | | | | | | | | | | | | | |
| Prerequisite | Position Control Mode | | | | | | | | | | | | | | | | | | | | | | | | | | | | |
| Remark | <ul style="list-style-type: none"> • Setting Control Level will invalidate the setting of Control gain set (113.0). • The specified values of Control Gain 1 (115.0) and Control Gain 2 (116.0) vary depending on Inertia conditions (113.1). | | | | | | | | | | | | | | | | | | | | | | | | | | | | |
| Related To | No. 113.0, No. 113.1, No. 115.0, No. 116.0 | | | | | | | | | | | | | | | | | | | | | | | | | | | | |



7 Tuning

| No. 115.0 | Tuning: Position control mode - Control gain 1 | Range | Default | Characteristics |
|--------------|--|------------|---------------|---|
| | | 5 to 1,000 | 50 [rad/s] |  |
| Function Use | <p>Set Control Gain 1 for <u>Position Control Mode</u>.</p> <p>Increasing this parameter value reduces position errors after the command becomes zero. Increase it when the position error convergence at the time of settling is not good. Set a value smaller than the value of Control Gain 2 (116.0).</p> | | | |
| Prerequisite | Position Control Mode | | | |
| Remark | <ul style="list-style-type: none"> • Making a change to any of the following will also change other tuning parameters (such as Control Gain 2) to the prearranged parameter set all at once. <ul style="list-style-type: none"> Control Gain Set (113.0) Inertia conditions (113.1) Control Level (114.0) • To reduce the position error of the command being input, raise Control Gain 2 (116.0). | | | |
| Related To | No. 113.0, No. 113.1, No. 114.0, No. 116.0, No. 117.0 | | | |

 7 Tuning

| No. 116.0 | Tuning: Position control mode - Control gain 2 | Range | Default | Characteristics |
|--------------|---|-------------|----------------|---|
| | | 80 to 5,000 | 200 [rad/s] |  |
| Function Use | <p>Set Control Gain 2 for <u>Position Control Mode</u>.</p> <p>Increasing this parameter value decreases the position error during command input. Increasing the parameter value provides faster command response; however, too large a value may result in noise. Set a value larger than the value of Control Gain 1 (115.0).</p> <p><u>Noise Solutions</u></p> <ol style="list-style-type: none"> ① Use Torque command filter: Notch filter (such as 160.1) ② Lower Integral Gain (119.0) <p>If the above does not work, decrease the Control Gain 2.</p> | | | |
| Prerequisite | Position Control Mode | | | |
| Remark | <ul style="list-style-type: none"> • Making a change to any of the following will also change other tuning parameters (such as Control Gain 1) to the prearranged parameter set all at once. <ul style="list-style-type: none"> Control Gain Set (113.0) Inertia conditions (113.1) Control Level (114.0) • To reduce position errors after the command becomes zero, increase the value of Control Gain 1(115.0). | | | |
| Related To | No. 113.0, No. 113.1, No. 114.0, No. 115.0, No. 118.0 | | | |

 7 Tuning

5. Parameters

| No. 117.0 | Tuning: Position control mode - Gain FF compensation 1 | Range | Default | Characteristics |
|--------------|---|-------------|--------------------|-----------------|
| | | 0 to 15,000 | 10,000 [0.01 %] | |
| Function Use | <p>Set the Feed Forward Compensation Rate (speed) with respect to [Control Gain 1 (115.0)] for Position Control Mode. Using this parameter is effective to shorten the settling time.</p> <p>Adjust this value after setting the following: Inertia ratio (102.0), Control gain set (113.0), Control level (114.0), Control gain 1 (115.0), Control gain 2 (116.0) Too high a value of this parameter will result in overshooting, and too low in undershooting. Set a relatively moderate value.</p> | | | |
| Prerequisite | Position Control Mode | | | |
| Related To | No. 113.0, No. 115.0, No. 118.0 | | | |





| No. 118.0 | Tuning: Position control mode - Gain FF compensation 2 | Range | Default | Characteristics |
|--------------|--|-------------|---------------|-----------------|
| | | 0 to 15,000 | 0 [0.01 %] | |
| Function Use | <p>Set Feed Forward Compensation Rate (Torque) with respect to [Control Gain 2 (No.116.0)] for Position Control Mode.</p> <p>Using this value will reduce position errors during operation. Setting this item to around 10,000 will make the position errors during operation almost zero. Raise the value of this item only after reducing the position error, by using Gain FF Compensation 1 (117.0) at settling.</p> <p><u>Noise Solutions</u> Adjusting Filter 4: Smoothing 2- Moving average counter (81.0) may reduce the noise.</p> | | | |
| Prerequisite | Position Control Mode | | | |
| Related To | No. 113.0, No. 116.0, No. 117.0 | | | |



| | | | | |
|--------------|---|-------------|----------------|---|
| No. 119.0 | Tuning: Position control mode - Integral gain | Range | Default | Characteristics |
| | | 45 to 5,000 | 160 [rad/s] |  |
| Function Use | Set the Integral Gain for <u>Position Control mode</u> . | | | |
| | Increasing the value of Integral Gain will improve the convergence (limited by friction or load fluctuation) at the time of settling, and reduce position errors. This will result in rigid and sensitive motion. | | | |
| Prerequisite | Position Control Mode | | | |
| | Remark: This parameter will reset to the default if Inertia conditions (113.1) or Control Gain Set (113.0) is changed. | | | |
| Related To | No. 113.0 | | | |

 7 Tuning

| | | | | |
|--------------|---|-----------|---------|--|
| No. 120.0 | Tuning: Control gain set – Automatic Enable switch | Settings | Default | Characteristics |
| | | 0, 1 | 0 |  |
| Function Use | Enable/Disable Auto Tuning for Control Gain Set | | | |
| | Settings | Selection | | |
| | 0 | Disable | | |
| 1 | Enable | | | |
| Prerequisite | Position Control Mode | | | |
| Remark | Only Quick Tuning Mode with the Setup Panel. This parameter is not displayed in Digitax SF Connect. | | | |
| Related To | No. 106.0, No. 120.1 | | | |

| | | | | |
|--------------|---|---------|---------|---|
| No. 120.1 | Tuning: Control gain set - Upper limit | Range | Default | Characteristics |
| | | 5 to 45 | 15 |  |
| Function Use | Set the upper limit of Control Gain Set in Auto Tuning of Control Gain Set. | | | |
| Prerequisite | Position Control Mode | | | |
| Related To | No. 106.0, No. 120.0 | | | |

5. Parameters

| | | | | |
|--------------|---|----------|---------|---|
| No. 121.0 | Tuning: Control gain set - Tuning constant | Range | Default | Characteristics |
| | | 1 to 200 | 24 |  |
| Function Use | <p><u>This parameter is used for Quick Tuning.</u> Usually the default value is used.</p> <p>It is a constant of proportionality to calculate (Control Gain 1 + Control Gain 2) based on the Inertia ratio setting value in their inverse proportionality. Set it to a small value only if Quick Tuning has caused vibration in an extremely poor rigidity equipment.</p> | | | |
| Prerequisite | Position Control Mode Tuning: Control gain set - Automatic switch (120.0) : 1 (Enable) | | | |
| Remark | This parameter is not displayed on the Setup Panel. | | | |
| Related To | No. 120.0 | | | |

| No. 129.0 | Tuning: Velocity control mode - Control gain set | Range | Default | Characteristics | | | | | | | | | | | | | | | | | | | | | | | | | |
|--------------|---|----------|---------------|---|---------|------------------|----------|---------------|----------------------|---|--------|-------|--------|-------|---|---|---|---|---|---|---|---|---|---|----|--------|--------|---------|--------|
| | | 1 to 46 | 15 |  | | | | | | | | | | | | | | | | | | | | | | | | | |
| Function Use | <p>Set the Control Gain Set for <u>Velocity Control Mode</u>. With this, Control gain 1 (131.0) and Integral gain (133.0) will be set to the default together.</p> <p><u>Noise Solutions</u></p> <ul style="list-style-type: none"> ① Use Torque command filter: Notch filter (such as 160.1) ② Decrease Integral gain (133.0) <p>If the above does not work, lower the Control Gain Set.</p> <table border="1" data-bbox="386 1249 1412 1429"> <thead> <tr> <th>Setting</th> <th>Command Response</th> <th>Rigidity</th> <th>Settling Time</th> <th>Possibility of Noise</th> </tr> </thead> <tbody> <tr> <td>1</td> <td>slower</td> <td>lower</td> <td>longer</td> <td>lower</td> </tr> <tr> <td>↑</td> <td>↑</td> <td>↑</td> <td>↑</td> <td>↑</td> </tr> <tr> <td>↓</td> <td>↓</td> <td>↓</td> <td>↓</td> <td>↓</td> </tr> <tr> <td>46</td> <td>faster</td> <td>higher</td> <td>shorter</td> <td>higher</td> </tr> </tbody> </table> | | | | Setting | Command Response | Rigidity | Settling Time | Possibility of Noise | 1 | slower | lower | longer | lower | ↑ | ↑ | ↑ | ↑ | ↑ | ↓ | ↓ | ↓ | ↓ | ↓ | 46 | faster | higher | shorter | higher |
| Setting | Command Response | Rigidity | Settling Time | Possibility of Noise | | | | | | | | | | | | | | | | | | | | | | | | | |
| 1 | slower | lower | longer | lower | | | | | | | | | | | | | | | | | | | | | | | | | |
| ↑ | ↑ | ↑ | ↑ | ↑ | | | | | | | | | | | | | | | | | | | | | | | | | |
| ↓ | ↓ | ↓ | ↓ | ↓ | | | | | | | | | | | | | | | | | | | | | | | | | |
| 46 | faster | higher | shorter | higher | | | | | | | | | | | | | | | | | | | | | | | | | |
| Prerequisite | Velocity Control Mode | | | | | | | | | | | | | | | | | | | | | | | | | | | | |
| Remark | <ul style="list-style-type: none"> • Too large a value may result in noise. • If Torque command filter: Low-pass filter constant (162.0) is set to 1 (auto setting ON), Torque command filter: Low-pass filter auto setting (160.2) will be included in the gain set. | | | | | | | | | | | | | | | | | | | | | | | | | | | | |
| Related To | No. 131.0, No. 132.0, No. 133.0, No. 162.0 | | | | | | | | | | | | | | | | | | | | | | | | | | | | |

 7 Tuning

| | | | | |
|--------------|---|------------------|----------|-----------------|
| No. 130.0 | Tuning: Velocity control mode - Control level | Range | Default | Characteristics |
| | | 1 to 46 | 15 | |
| Function Use | Specify the Control Level for <u>Velocity Control Mode</u> . | | | |
| | Sets Control Gain 1 (131.0) to the preset value which was prepared for each required control level. | | | |
| | <u>Noise Solutions</u> ① Use Torque command filter: Notch filter (such as 160.1). ② Decrease Integral Gain (133.0). If any of the above does not work, then lower the Control Level . | | | |
| | Setting | Command Response | Rigidity | Settling Time |
| 1 | slower | lower | longer | lower |
| ↑ | ↑ | ↑ | ↑ | ↑ |
| ↓ | ↓ | ↓ | ↓ | ↓ |
| 46 | faster | higher | shorter | higher |
| Prerequisite | Velocity Control Mode | | | |
| Remark | Setting Control Level will invalidate the setting of Control gain set (129.0). | | | |
| Related To | No. 129.0, No. 131.0, No. 133.0, No. 162.0 | | | |

7 Tuning

| | | | | |
|--------------|---|--------------|-------------|-----------------|
| No. 131.0 | Tuning: Velocity control mode - Control gain 1 | Range | Default | Characteristics |
| | | 100 to 6,000 | 399 [rad/s] | |
| Function Use | Set Control Gain 1 for <u>Velocity Control Mode</u> . | | | |
| | The larger this parameter is, the smaller the speed error relative to the command the command being input will become. | | | |
| | Increasing this parameter value provides faster command response; however, too large a value may result in noise. | | | |
| | <u>Noise Solutions</u> ① Use Torque command filter: Notch filter (such as 160.1). ② Decrease Integral Gain (133.0). If any of the above does not work, lower the Control Gain 1 . | | | |
| Prerequisite | Velocity Control Mode | | | |
| Remark | Making a change to any of the following will also change other tuning parameters (such as Gain FF Compensation 1) to the prearranged parameter set all at once. <ul style="list-style-type: none"> • Control gain set (129.0) • Control level (130.0) | | | |
| Related To | No. 129.0, No. 130.0, No. 132.0 | | | |

7 Tuning

5. Parameters

| | | | | |
|--------------|---|-------------|--------------|-----------------|
| No. 132.0 | Tuning: Velocity control mode - Gain FF compensation 1 | Range | Default | Characteristics |
| | | 0 to 15,000 | 0 [rad/s] | |
| Function Use | <p>Set Feed Forward Compensation Rate with respect to Control Gain 1 for Velocity Control Mode.</p> <p>Increase the value of this parameter to provide faster command response. In the event of noise, decrease the setting by a small amount.</p> | | | |
| Prerequisite | Velocity Control Mode | | | |
| Related To | No. 129.0, No. 130.0, No. 131.0, No. 133.0, No. 162.0 | | | |









7 Tuning

| | | | | |
|--------------|---|-------------|----------------|-----------------|
| No. 133.0 | Tuning: Velocity control mode - Integral gain | Range | Default | Characteristics |
| | | 45 to 5,000 | 300 [rad/s] | |
| Function Use | <p>Set the Integral Gain for Velocity Control Mode.</p> <p>Increase the value of Integral Gain to improve the convergence (interfered by friction or load fluctuation) at the time of settling, and reduce position errors. This will result in rigid and sensitive motion.</p> <p><u>Noise Solutions</u></p> <ol style="list-style-type: none"> ① Use Torque command filter: Notch filter (such as 160.1). ② Decrease the value of Integral Gain. | | | |
| Prerequisite | Velocity Control Mode | | | |
| Remark | This parameter will reset to the prearranged value if Inertia conditions or Control Gain Set is changed. | | | |
| Related To | No. 129.0, No. 130.0, No. 131.0, No. 132.0, No. 162.0 | | | |

7 Tuning

| | | | | | |
|--------------|---|---------------------------|------------------------------|------------------------------------|--|
| No. 144.0 | Torque command limit: Switch | Settings | Default | Characteristics | |
| | | 0, 1 | 0 | | |
| Function Use | Enable/Disable Torque Command Limit | | | | |
| | Settings | Selection | Error Detection | | |
| | | | Position error: 65.0 | Error Detection Value : 87.0, 90.0 | |
| | | | Speed error : 65.1 | Delay time : 89.0, 91.0 | |
| | 0 | Disable | - | - | |
| 1 | Enable | 0 (Disable) 1 (Enable) | - | | |
| | | | Select an appropriate value. | | |
| | If you are to select 1 for this parameter, configure the above settings so that Position error (Alarm No.6) and Speed error (Alarm No.5) will be avoided. | | | | |
| Related To | No. 65.0, No. 65.1, No. 87.0, No. 89.0, No. 90.0, No. 91.0 | | | | |

5. Parameters

| | | | | | | |
|---------------|--|---|---|---|--|-----------------------------|
| No. 144.1 | Torque command limit: Torque limit output | Settings | Default | Characteristics | | |
| | | 0 to 2 | 0 |    -  | | |
| Function Use | Select one of the condition sets to indicate that the motor is in a “torque limiting state” . | | | | | |
| | T-LIMIT (Pin No.17) of I/O connector will indicate the torque limiting state, when, in each row in the table below, 1) any of the parameters marked ○ is set with a valid value, or 2) the one marked with △ is not configured. | | | | | |
| | Settings | Torque command limit: Value 1 No. 147.0 | Torque command limit: Value 2 No. 148.0 | Motor Max output Torque value | Homing Torque command limit value No. 656.0 | Speed Limit No. 152.0 |
| | 0 | ○ | ○ | ○ | ○ | △ |
| | 1 | ○ | ○ | - | - | - |
| 2 | - | ○ | - | - | - | |
| Prerequisite | Torque command limit switch (144.0) = 1 (Enable) | | | | | |
| Related To | No. 144.0, No. 147.0, No. 148.0, No. 152.0, No. 656.0 | | | | | |
| No. 147.0 | Torque command limit: Value 1 | Range | Default | Characteristics | | |
| | | 0 to 65,535 | (See below) |    -  | | |
| No. 148.0 | Torque command limit: Value 2 | 0 to 65,535 | 2,000 [0.1 %] | | | |
| Function Use | Set a torque command limit value as % of the rated torque (100 %). | | | | | |
| | Two torque command limits can be set with Value 1 and 2. | | | | | |
| | <ul style="list-style-type: none"> When TLSEL1 (Pin No.11) of the I/O connector is open, Value 1 (147.0) is applied. When closed, Value 2 (148.0) will be applied. The setting of 3,000 or above indicates 300 % of the max rated torque. If the parameter is set to above 1,000, an overload error will occur in the specified time, depending on the overload characteristic. Under some operating conditions, overcurrent error may occur. If this happens, set the upper limit to 2,400. | | | | | |
| | Motor Capacity | No. 147.0 Default | | | | |
| 50 W, 100 W | 3,500 [0.1%] | | | | | |
| 200 W to 2 kW | 3,000 [0.1%] | | | | | |
| Prerequisite | Torque command limit switch (144.0) = 1 (Enable) | | | | | |
| Related To | No. 144.0, No. 144.1 | | | | | |

5. Parameters

| | | | | |
|--------------|--|-------------|------------------|-----------------|
| No. 151.0 | Deceleration stop: Torque command limit | Range | Default | Characteristics |
| | | 0 to 65,535 | 2,400 [0.1 %] | |
| Function Use | <p>If [Deceleration stop: Method (when the servo is off) (No.224.0)] = 2 (quick stop), set the value of torque command limit at the time of a quick stop as a ratio to the rated torque (100 %).</p> <ul style="list-style-type: none"> • The setting of 3,000 or above results in 300 % of the max torque of each motor. • If the parameter is set to above 1,000, an overload error will occur in the given time, depending on the overload characteristic. • Under some operating conditions, overcurrent error may occur. If this happens, set the upper limit to the range with 2,400. | | | |
| Prerequisite | Deceleration stop: Method (upon servo is off) (224.0) = 2 (Quick stop) | | | |
| Related To | No. 224.0 | | | |

| No. 152.0 | Analog torque: Speed Limit | Range | Default | Characteristics | | | | | | | | | | |
|---|---|-------------|-------------|-----------------|-------------|---------------|---|-------|-------------------------------|-------|--------------|-------|---|-------|
| | | 0 to 10,000 | (See below) | | | | | | | | | | | |
| Function Use | <p>Set the speed limit for <u>Analog Torque Mode</u>.</p> <p>The default value of this parameter equals to the value of max rotation speed in the table below.</p> <table border="1"> <thead> <tr> <th>Motor Model</th> <th>Default [rpm]</th> </tr> </thead> <tbody> <tr> <td>MM500, MY500, MM101, MY101, MX201, MZ201, MX401, MZ401, MX751, MZ751,</td> <td>6,000</td> </tr> <tr> <td>MA201, MH201, MA401, MH401</td> <td>5,000</td> </tr> <tr> <td>MA751, MH751</td> <td>4,500</td> </tr> <tr> <td>MM102, MH102, MM152, MH152, MM202</td> <td>3,000</td> </tr> </tbody> </table> | | | | Motor Model | Default [rpm] | MM500, MY500, MM101, MY101, MX201, MZ201, MX401, MZ401, MX751, MZ751, | 6,000 | MA201, MH201, MA401, MH401 | 5,000 | MA751, MH751 | 4,500 | MM102, MH102, MM152, MH152, MM202 | 3,000 |
| Motor Model | Default [rpm] | | | | | | | | | | | | | |
| MM500, MY500, MM101, MY101, MX201, MZ201, MX401, MZ401, MX751, MZ751, | 6,000 | | | | | | | | | | | | | |
| MA201, MH201, MA401, MH401 | 5,000 | | | | | | | | | | | | | |
| MA751, MH751 | 4,500 | | | | | | | | | | | | | |
| MM102, MH102, MM152, MH152, MM202 | 3,000 | | | | | | | | | | | | | |
| Prerequisite | Torque Control Mode | | | | | | | | | | | | | |

| No. 160.0 | Torque command filter: Low-pass filter - Enable Switch | Settings | Default | Characteristics | | | | | | |
|--------------|---|----------|---------|-----------------|----------|-----------|---|---------|---|--------|
| | | 0, 1 | 1 | | | | | | | |
| Function Use | <p>Enable/Disable Low-pass filter.</p> <p>This filter is a first-order IIR filter.</p> <table border="1"> <thead> <tr> <th>Settings</th> <th>Selection</th> </tr> </thead> <tbody> <tr> <td>0</td> <td>Disable</td> </tr> <tr> <td>1</td> <td>Enable</td> </tr> </tbody> </table> | | | | Settings | Selection | 0 | Disable | 1 | Enable |
| Settings | Selection | | | | | | | | | |
| 0 | Disable | | | | | | | | | |
| 1 | Enable | | | | | | | | | |
| Related To | No. 113.0, No. 160.2, No. 162.0 | | | | | | | | | |

7 Tuning

| No. 160.1 | Torque command filter: Notch filter - Enable Switch | Settings | Default | Characteristics | | | | | | |
|--------------|--|----------|---------|-----------------|----------|-----------|---|---------|---|--------|
| | | 0, 1 | 0 | | | | | | | |
| Function Use | <p>Enable/Disable Notch filter.</p> <table border="1"> <thead> <tr> <th>Settings</th> <th>Selection</th> </tr> </thead> <tbody> <tr> <td>0</td> <td>Disable</td> </tr> <tr> <td>1</td> <td>Enable</td> </tr> </tbody> </table> | | | | Settings | Selection | 0 | Disable | 1 | Enable |
| Settings | Selection | | | | | | | | | |
| 0 | Disable | | | | | | | | | |
| 1 | Enable | | | | | | | | | |
| Related To | No. 168.0, No. 169.0, No. 170.0 | | | | | | | | | |

7 Tuning

| | | | | |
|--------------|---|------------------|---------|-----------------|
| No. 160.2 | Torque command filter: Low-pass filter - Auto setting | Settings | Default | Characteristics |
| | | 0, 1 | 0 | |
| Function Use | Enable/Disable the automatic configuration of [Torque command filter: Low-pass filter time constant (162.0)] according to the settings of the control gain sets; Position Control Mode (113.0) and Velocity Control Mode (129.0). | | | |
| | Settings | Auto setting | | |
| | 0 | Auto setting OFF | | |
| | 1 | Auto setting ON | | |
| Prerequisite | Torque command filter: Low-pass filter switch (160.0) = 1 (Enable) | | | |
| Related To | No. 113.0, No.129.0, No. 160.0, No. 162.0 | | | |

7 Tuning





| | | | | |
|--------------|--|--------------------------------|---------|-----------------|
| No. 160.3 | Torque command filter: Notch filter 2 - Enable Switch | Settings | Default | Characteristics |
| | | 0, 1 | 0 | |
| Function Use | Enable/Disable Torque command Notch filter 2 | | | |
| | Settings | Torque command- Notch filter 2 | | |
| | 0 | Disable | | |
| | 1 | Enable | | |
| Related To | No. 171.0, No. 172.0, No. 173.0 | | | |

7 Tuning





| | | | | |
|---------------|--|-----------------------|-------------|-----------------|
| No. 162.0 | Torque command filter: Low-pass filter - Time constant | Range | Default | Characteristics |
| | | 0 to 65,535 | (See below) | |
| Function Use | Set the primary IIR filter time constant of [Torque command filter: Low-pass filter switch (160.0)] = 1 (Enable) | | | |
| | Condition for Time Constant: | | | |
| | $\frac{(0.1 \text{ to } 0.2)}{\max(\omega_1 + \omega_2, \omega_q)} \text{ [s] or below}$ | | | |
| | Motor Capacity | Default [0.01 ms/rad] | | |
| 50 W, 100 W | 0 | | | |
| 200 W to 2 kW | 10 | | | |
| Prerequisite | Torque command filter: Low-pass filter switch (160.0) = 1 (Enable) | | | |
| Remark | Example: Calculating in time unit and converting to frequency 20 [0.01 ms/rad] → 5,000 [rad/s] (equivalent to 796 [Hz]) | | | |
| Related To | No.113.0, No.160.0, No.160.2 | | | |

7 Tuning





5. Parameters

| | | | | |
|--------------|---|------------|------------|---|
| No. 168.0 | Torque command filter: Notch filter - Frequency | Range | Default | Characteristics |
| | | 0 to 2,500 | 2,500 [Hz] |    -  |
| Function Use | Set the notch frequency for the Torque command filter - notch filter. | | | |
| Prerequisite | Torque command filter: Notch filter switch (160.1) = 1 (Enable) | | | |
| Related To | No. 160.1, No. 169.0, No. 170.0 | | | |





 7 Tuning

| | | | | |
|--------------|---|---------|-------------|---|
| No. 169.0 | Torque command filter: Notch filter - Width | Range | Default | Characteristics |
| | | 1 to 16 | 8 |    -  |
| Function Use | Set the notch width of torque command notch filter. | | | |
| | In the default setting of this parameter, notch width=notch frequency (a factor of x1). The larger this item is, the larger the notch width is. In the case of multiple notch frequencies, this item increases the notch width. | | | |
| | Setting | Factor | Notch Width | |
| | 16 | x2 | large | |
| | 12 | x1.5 | ↑ | |
| 8 | x1 | ↓ | | |
| 4 | x0.5 | small | | |
| Prerequisite | Torque command filter: Notch filter switch (160.1) = 1 (Enable) | | | |
| Related To | No. 160.1, No. 168.0, No. 170.0 | | | |





 7 Tuning

| | | | | |
|--|--|---|---------|---|
| No. 170.0 | Torque command filter: Notch filter - Depth | Range | Default | Characteristics |
| | | 0 to 256 | 0 |    -  |
| Function Use | Set the depth at the notch frequency of Torque command Notch filter. | | | |
| | Setting | Notch Depth | | |
| | 0 | complete shutoff of notch frequency input | | |
| | ↑ | ↑ | | |
| | ↓ | ↓ | | |
| 256 | 100 % pass-through | | | |
| <ul style="list-style-type: none"> • The larger this item is, the shallower the notch depth is. • If the noise cannot be eliminated by setting a notch filter, increase the setting gradually (e.g., 50, 100, 150 and so on), which decreases the notch depth. | | | | |
| Prerequisite | Torque command filter: Notch filter switch (160.1) = 1 (Enable) | | | |
| Related To | No. 160.1, No. 168.0, No. 169.0 | | | |





 7 Tuning

| | | | | |
|--------------|---|------------|------------|---|
| No. 171.0 | Torque command filter: Notch filter 2 - Frequency | Range | Default | Characteristics |
| | | 0 to 2,500 | 2,500 [Hz] |    -  |
| Function Use | Set the notch frequency of torque command notch filter 2. | | | |
| Prerequisite | Torque command filter: Notch filter 2 switch (160.3) = 1 (Enable) | | | |
| Related To | No. 160.3, No. 172.0, No. 173.0 | | | |

 7 Tuning





| No. 172.0 | Torque command filter: Notch filter 2 - Width | Range | Default | Characteristics | | | | | | | | | | | | | | | |
|--------------|--|-------------|---------|---|---------|--------|-------------|----|----|-------|----|------|---|---|----|---|---|------|-------|
| | | 1 to 16 | 8 |    -  | | | | | | | | | | | | | | | |
| Function Use | <p>Set the notch width of torque command notch filter 2.</p> <p>In the default setting of this parameter, notch width=notch frequency (a factor of x1). The larger this item is, the larger the notch width is. In the case of multiple notch frequencies, this item increases the notch width.</p> <table border="1"> <thead> <tr> <th>Setting</th> <th>Factor</th> <th>Notch Width</th> </tr> </thead> <tbody> <tr> <td>16</td> <td>x2</td> <td>large</td> </tr> <tr> <td>12</td> <td>x1.5</td> <td>↑</td> </tr> <tr> <td>8</td> <td>x1</td> <td>↓</td> </tr> <tr> <td>4</td> <td>x0.5</td> <td>small</td> </tr> </tbody> </table> | | | | Setting | Factor | Notch Width | 16 | x2 | large | 12 | x1.5 | ↑ | 8 | x1 | ↓ | 4 | x0.5 | small |
| Setting | Factor | Notch Width | | | | | | | | | | | | | | | | | |
| 16 | x2 | large | | | | | | | | | | | | | | | | | |
| 12 | x1.5 | ↑ | | | | | | | | | | | | | | | | | |
| 8 | x1 | ↓ | | | | | | | | | | | | | | | | | |
| 4 | x0.5 | small | | | | | | | | | | | | | | | | | |
| Prerequisite | Torque command filter: Notch filter 2 switch (160.3) = 1 (Enable) | | | | | | | | | | | | | | | | | | |
| Related To | No. 160.3, No. 171.0, No. 173.0 | | | | | | | | | | | | | | | | | | |









 7 Tuning





| No. 173.0 | Torque command filter: Notch filter 2 - Depth | Range | Default | Characteristics | | | | | | | | | | |
|--------------|---|----------|---------|---|---------|-------------|---|------------------|---|---|---|---|-----|--------------------|
| | | 0 to 256 | 0 |    -  | | | | | | | | | | |
| Function Use | <p>Set the depth at the notch frequency of Torque command Notch filter 2.</p> <table border="1"> <thead> <tr> <th>Setting</th> <th>Notch Depth</th> </tr> </thead> <tbody> <tr> <td>0</td> <td>0 % pass-through</td> </tr> <tr> <td>↑</td> <td>↑</td> </tr> <tr> <td>↓</td> <td>↓</td> </tr> <tr> <td>256</td> <td>100 % pass-through</td> </tr> </tbody> </table> <ul style="list-style-type: none"> • The larger this item is, the shallower the notch depth is. • If the noise cannot be eliminated by setting a notch filter, increase the setting gradually (e.g., 50, 100, 150 and so on), which decreases the notch depth. | | | | Setting | Notch Depth | 0 | 0 % pass-through | ↑ | ↑ | ↓ | ↓ | 256 | 100 % pass-through |
| Setting | Notch Depth | | | | | | | | | | | | | |
| 0 | 0 % pass-through | | | | | | | | | | | | | |
| ↑ | ↑ | | | | | | | | | | | | | |
| ↓ | ↓ | | | | | | | | | | | | | |
| 256 | 100 % pass-through | | | | | | | | | | | | | |
| Prerequisite | Torque command filter: Notch filter switch (160.1) = 1 (Enable) | | | | | | | | | | | | | |
| Related To | No. 160.3, No. 171.0, No. 172.0 | | | | | | | | | | | | | |

 7 Tuning

5. Parameters













| | | | | |
|--------------|--|----------|---------|---|
| No. 193.0 | Tuning: Current control gain switch | Settings | Default | Characteristics |
| | | 0, 1 | 0 |      |
| Function Use | This parameter is used to adjust the gain level of the current control component. | | | |
| | Select 1 to reduce noise generated at the time of servo-on stop. | | | |
| | Settings | Level | Noise | Response |
| 0 | standard | more | faster | |
| 1 | low | less | slower | |
| Remark | <ul style="list-style-type: none"> • If you changed the setting, perform tuning again. • Selecting 1 reduces the response; Adjust within the acceptable range. | | | |

| | | | | |
|--------------|---|---|---------------|---|
| No. 224.0 | Deceleration stop: Method (upon Servo Off) | Settings | Default | Characteristics |
| | | 0 to 3 | 1 |     |
| Function Use | Specify the deceleration stop method in case of servo off while motor is rotating. | | | |
| | Settings | Description | | |
| | 0 |  | Coast to stop | |
| | 1 |  | Short brake | |
| | 2 |  | Quick stop | |
| 3 |  | Emergency stop brake | | |
| Related To | No. 151.0, No. 224.1, No. 224.3, No. 225.2, No. 226.0, No. 227.0, No. 229.0, No. 232.1, No. 232.2, No. 236.0, No. 239.0 | | | |

| | | | | |
|--------------|---|--|--|---|
| No. 224.1 | Deceleration stop: Release conditions | Settings | Default | Characteristics |
| | | 0, 1 | 1 |     |
| Function Use | This parameter indicates conditions to cancel a deceleration stop, if an alarm occurs or the Servo ON signal turns OFF. | | | |
| | It is used for a motor which is slowing down as specified with Deceleration stop: Method (upon Servo Off) (224.0). | | | |
| | Settings | Deceleration stop Operating time (No. 226.0) | Deceleration stop Rotational speed to cancel (No. 227.0) | |
| 0 | ○ | - | | |
| 1 | ○ | ○ | | |
| Prerequisite | Deceleration stop Method (upon servo off)(224.0) = 1 (Short brake) or 2 (Quick stop) | | | |
| Related To | No. 224.0, No. 226.0, No. 227.0 | | | |

| | | | | |
|--------------|---|---|---------|-----------------|
| No. 224.2 | Deceleration stop: Enable Switch (upon AC Supply loss) | Settings | Default | Characteristics |
| | | 0, 1 | 1 | |
| Function Use | Enable/Disable deceleration stop when an AC supply loss condition occurs. | | | |
| | Settings | Selection | | |
| | 0 | Disable | | |
| | 1 | Enable | | |
| Related To | No. 228.0 | | | |
| No. 224.3 | Deceleration stop: DBRK output after stopping (upon Servo Off) | Settings | Default | Characteristics |
| | | 0, 1 | 1 | |
| Function Use | Select Stop State when the servo is off | | | |
| | Settings | Description | | |
| | 0 | Coast to stop | | |
| | 1 | Emergency stop brake | | |
| Prerequisite | No. 224.0, No.232.1 | | | |
| No. 225.0 | Emergency stop: Warning output enable switch | Settings | Default | Characteristics |
| | | 0, 1 | 0 | |
| Function Use | Set whether a warning is to be output or not in case of E-stop input. | | | |
| | Settings | Warning output | | |
| | 0 | Disable | | |
| | 1 | Enable | | |
| No. 225.1 | Emergency stop: Warning output timing | Settings | Default | Characteristics |
| | | 0, 1 | 0 | |
| Function Use | Specify when to output a warning in case of E-stop input. | | | |
| | Settings | Warning output timing | | |
| | 0 | After the motor makes a deceleration stop | | |
| | 1 | Immediately after the warning occurs | | |
| Prerequisite | Emergency stop: Warning output switch (225.0) = 1 (Output warning) | | | |
| No. 225.2 | Quick stop: Smoothing filter - Enable Switch | Settings | Default | Characteristics |
| | | 0, 1 | 0 | |
| Function Use | Enable/Disable the Velocity Command smoothing filter at the time of a quick stop. | | | |
| | This filter suppresses vibration caused by drastic velocity change. | | | |
| | Settings | Velocity Command smoothing filter | | |
| | 0 | Disable | | |
| | 1 | Enable | | |
| Prerequisite | No. 229.0 | | | |

5. Parameters

| | | | | |
|--------------|---|--------------|-----------------------|---|
| No. 226.0 | Deceleration stop: Operating time | Range | Default | Characteristics |
| | | 0 to 16,383 | (See below) |    -  |
| Function Use | This parameter defines the deceleration stop operation time when an alarm occurs or the Servo ON signal turns OFF. It is used for a motor which is slowing down as specified with the deceleration stop method (224.0). | | | |
| | Motor Capacity | Default | Units | Converted to Time |
| | 50 W to 750 W | 313 | 160 μs | 50 [ms] |
| | 1 kW to 2 kW | 250 | 200 μs | |
| Prerequisite | Deceleration stop Method (upon servo off)(224.0) = 1 (Short brake) or 2 (Quick stop)) | | | |
| Related To | No. 224.0, No. 224.1, No. 227.0 | | | |
| No. 227.0 | Deceleration stop: Cancellation speed | Range | Default | Characteristics |
| | | 0 to 32,767 | (See below) |    -  |
| Function Use | This parameter defines the rotational speed to cancel deceleration-stop in case an alarm occurs or the Servo ON signal turns OFF. | | | |
| | It is used for a motor which is slowing down as specified with the deceleration stop method (224.0). | | | |
| | Motor Capacity | Default | Units [encoder pulse] | Conversion to Rotational Speed |
| | 50 W to 750 W | 17 | pulse/160 μs | 50 [rpm] |
| 1 kW to 2 kW | 22 | pulse/200 μs | | |
| Prerequisite | Deceleration stop: Method (224.0) = 1 (Short brake) or 2 (Quick stop) & Deceleration stop: Release conditions (224.1) = 1 | | | |
| Related To | No. 224.0, No. 224.1, No. 226.0 | | | |
| No. 228.0 | Deceleration stop: Operating time (upon control power error) | Range | Default | Characteristics |
| | | 0 to 16,383 | (See below) |    -  |
| Function Use | Set Deceleration stop time in the event an alarm condition due to a AC Supply loss. | | | |
| | Motor Capacity | Default | Units | Converted to Time |
| | 50 W to 750 W | 62 | 160 μs | 10 [ms] |
| | 1 kW to 2kW | 52 | 200 μs | |
| Prerequisite | Deceleration stop: Switch (upon AC Supply loss) (224.2) = 1 (Enable) | | | |
| Related To | No. 224.2 | | | |

| | | | | |
|--|--|---------------------------------------|---------|-----------------|
| No. 229.0 | Quick stop: Smoothing filter - Moving average counter | Range | Default | Characteristics |
| | | 1 to 1,000 | 25 | |
| Function Use | This item defines the moving average count of the speed command smoothing filter while the motor is making a quick stop. | | | |
| | The larger the parameter value, the smoother acceleration/deceleration is and the slower the response. | | | |
| | Motor Capacity | Delay Time Calculation Formula | | |
| 50 W to 750 W | 0.16 [ms] | × (moving average count) = delay time | | |
| 1 kW to 2 kW | 0.2 [ms] | | | |
| The positioning will take as long as the delay time specified above, set this item within the range acceptable to the equipment. | | | | |
| Prerequisite | Quick stop: Smoothing filter switch (225.2) = 1 (Enable) | | | |
| Related To | No. 225.2, No. 239.0 | | | |

Waveforms for each combination of enable/disable Deceleration Stop and Smoothing Filter.

| | | | |
|-------------------|---------|---------|--------|
| Deceleration Stop | Disable | Enable | Enable |
| Smoothing Filter | Disable | Disable | Enable |
| Command waveform | | | |

| | | | | |
|--------------|---|--|---------|-----------------|
| No. 232.1 | Deceleration stop: Status during coast to stop | Settings | Default | Characteristics |
| | | 0, 1 | 0 | |
| Function Use | Select on or off for deceleration stop status during coast to stop. | | | |
| | Settings | Deceleration stop status | | |
| | 0 | <p>OFF (not consider as deceleration stop)</p> <p>As soon as the servo status becomes OFF, the motor brake release (MBRK) becomes open and the motor brake becomes engaged.</p> <p>With the configuration of No.224.3 (upon servo off) and No.233.3 (upon alarm on), the emergency stop brake release signal (DBRK) immediately turns off and the emergency stop brake becomes engaged.</p> | | |
| 1 | <p>ON (consider as deceleration stop)</p> <p>When the servo state becomes OFF, the deceleration stop status becomes ON. MBRK remains closed and the motor brake remains disengaged until the deceleration stop status becomes OFF.</p> <p>With the configuration of No.224.3 (upon servo off) and No.233.3 (upon alarm on), the emergency stop brake release (DBRK) will remain ON and the emergency stop brake will remain disengaged until the deceleration stop status becomes OFF.</p> | | | |

5. Parameters

| | | | | |
|--------------|---|--|---------|-----------------|
| No. 232.2 | Quick stop: Short brake operation after a stop | Settings | Default | Characteristics |
| | | 0, 1 | 0 | |
| Function Use | Enable/Disable short braking after a quick stop. | | | |
| | Settings | Short braking | | |
| | 0 | Enable | | |
| | 1 | Disable | | |
| Prerequisite | Deceleration stop: Method (when servo off) (224.0) = 2 (Quick stop) | | | |
| No. 232.3 | Deceleration stop: Brake engagement - Timing | Settings | Default | Characteristics |
| | | 0, 1 | 0 | |
| Function Use | Set the timing for the brake to be engaged in a brake-equipped motor. | | | |
| | (That is, set the timing to open MBRK (Motor Brake Release)) | | | |
| | Settings | Timing | | |
| | 0 | When the deceleration stop status is off, or the motor rotation speed becomes lower than the setting of Deceleration stop: Cancellation speed (227.0) | | |
| | 1 | When the deceleration stop status is off, or the motor rotation speed becomes lower than the setting of Deceleration stop: Brake engagement - Rotation speed (235.0), or the braking time reaches the value of Deceleration stop: Brake engagement - Delay time (234.0). | | |
| Related To | No. 234.0, No. 235.0 | | | |

3 Preparation Timing Diagrams

| | | | | |
|--------------|--|-------------|--------------------|-----------------|
| No. 233.0 | Deceleration Stop: Method (when alarm is on) | Settings | Default | Characteristics |
| | | 0 to 7 | 2 | |
| Function Use | Select a deceleration stop method in case of alarm while motor is in motion. | | | |
| | Each alarm group uses a different stop method. (*1) | | | |
| | Settings | Stop method | | |
| | | Group ① | Group ② (*2), ③, ④ | Group ⑤ |
| | 0 | | | |
| | 1 | | | |
| | 2 | | | |
| | 3 | | | |
| | 4 | | | |
| | 5 | | | |
| 6 | | | | |
| 7 | | | | |

*1) Alarms are categorized into five groups.















*2) When Deceleration stop: Method (224.0) = 0 (Disable), the motor will be stopped by the group ① method.

After the amount of time specified by Deceleration stop: Operating time (228.0) elapses, the motor will be stopped by the group ① method.













Coast to stop
 Quick stop
 Short brake
 Emergency stop brake













| Alarm No. | Alarm Name and Group | Alarm No. | Alarm Name and Group |
|-----------|---|-----------|-----------------------------------|
| 0 | System ④ | 16 | Encoder (response data) ③ |
| 1 | EEPROM data ④ | 17 | Encoder (no response) ③ |
| 2 | Product code ④ | 18 | Encoder (circuitry) ③ |
| 4 | Overspeed ⑤ | 19 | Encoder (communication) ③ |
| 5 | Speed ⑤ | 20 | Encoder (multi-turn data) ③ |
| 6 | Position ⑤ | 21 | Encoder (voltage drop) ③ |
| 7 | Overload ④ | 22 | Voltage (control power) ② |
| 8 | Command overspeed ⑤ | 23 | Switch circuitry ① |
| 9 | Encoder pulse output frequency ④ | 24 | Overcurrent ① |
| 10 | Positioning command overflow / Homing failure ⑤ | 25 | Inverter 1 ① |
| 11 | Encoder (multi-turn counter overflow) ⑤ | 26 | Inverter 2 ① |
| 12 | Overheat ⑤ | 27 | Current sensor ① |
| 14 | Overvoltage ① | 28 | Encoder overheat) ⑤ |
| 15 | Power supply (AC Supply) ⑤ | 29 | Voltage drop (inside the drive) ① |

5. Parameters

| | | | | | | |
|---|--|---|-------------|-------------------------------|-------------|---|
| No. 233.3 | Deceleration Stop: DBRK output after stopping (when alarm is on) | | | Settings | Default | Characteristics |
| | | | | 0, 1 | 0 |    -  |
| Function Use | Select the type of idling in case of alarm. | | | | | |
| | Settings | Idle State | | | | |
| | 0 |  Coast to stop | | | | |
| 1 |  Emergency stop brake | | | | | |
| No. 234.0 | Deceleration Stop: Brake engagement - Delay time | | | Range | Default | Characteristics |
| | | | | 0 to 16,383 | 0 |    -  |
| Function Use | Set the delay time between two events: 1) SVON (servo-on) opens while the motor is in motion or an alarm occurs, and 2) the brake becomes engaged. | | | | | |
| | Motor Capacity | Default | Units | Converted to Time | | |
| | 50 W to 750 W | 0 | 160 μ s | 0 [ms] | | |
| | 1 kW to 2 kW | 0 | 200 μ s | | | |
| Prerequisite Timing of brake engagement (232.3) = 1 | | | | | | |
| No. 235.0 | Deceleration Stop: Brake engagement - Rotational speed | | | Range | Default | Characteristics |
| | | | | 0 to 32,767 | (See below) |    -  |
| Function Use | Set the motor rotational speed to engage the brake when 1) SVON (servo-on) opens while the motor is in motion or 2) an alarm occurs. | | | | | |
| | Motor Capacity | Default | Units | Converted to rotational speed | | |
| | 50 W to 750 W | 17 | 160 μ s | 50 [rpm] | | |
| | 1 kW to 2 kW | 22 | 200 μ s | | | |
| Prerequisite Timing of brake engagement (232.3) = 1 | | | | | | |

| No. 236.0 | Quick stop: Extention Time | Range 0 to 3,125 | Default (See below) | Characteristics | | | | | | | | | | | |
|----------------|---|---------------------|------------------------|---------------------|----------------|---------|-------|--------------------|---------------|----|--------|--------|--------------|----|--------|
| Function Use | <p>This item indicates how long the quick stop to be kept active after the deceleration stop complete conditions were met.</p> <p>It is used to compensate the motor brake response time.</p> | | | | | | | | | | | | | | |
| | <table border="1"> <thead> <tr> <th>Motor Capacity</th> <th>Default</th> <th>Units</th> <th>Converting to Time</th> </tr> </thead> <tbody> <tr> <td>50 W to 750 W</td> <td>0</td> <td>160 µs</td> <td rowspan="2">0 [ms]</td> </tr> <tr> <td>1 kW to 2 kW</td> <td>0</td> <td>200 µs</td> </tr> </tbody> </table> | | | | Motor Capacity | Default | Units | Converting to Time | 50 W to 750 W | 0 | 160 µs | 0 [ms] | 1 kW to 2 kW | 0 | 200 µs |
| Motor Capacity | Default | Units | Converting to Time | | | | | | | | | | | | |
| 50 W to 750 W | 0 | 160 µs | 0 [ms] | | | | | | | | | | | | |
| 1 kW to 2 kW | 0 | 200 µs | | | | | | | | | | | | | |
| | <p>This parameter is valid only when the Deceleration Stop Method is "quick stop" . This parameter is invalid if the servo turns off while the motor idling. Use Servo OFF: Delay time (237.0) to compensate the motor brake response time when the servo turns off during motor idling.</p> | | | | | | | | | | | | | | |
| Prerequisite | Deceleration stop: Method (224.0) = 2 (Quick stop) | | | | | | | | | | | | | | |
| Related To | No. 224,0, No. 233.0, No. 237.0 | | | | | | | | | | | | | | |
| No. 237.0 | Servo OFF: Delay time | Range 0 to 3,125 | Default (See below) | Characteristics | | | | | | | | | | | |
| Function Use | <p>This parameter indicates the delay time the motor excitation off after the servo-on signal (SVON) turns off.</p> <p>By adjusting the timing to end motor excitation after the motor brake is engaged, brake-equipped axes such as vertical axis can be prevented from roll back.</p> | | | | | | | | | | | | | | |
| | <table border="1"> <thead> <tr> <th>Motor Capacity</th> <th>Default</th> <th>Units</th> <th>Converting to Time</th> </tr> </thead> <tbody> <tr> <td>50 W to 750 W</td> <td>0</td> <td>160 µs</td> <td rowspan="2">0 [ms]</td> </tr> <tr> <td>1 kW to 2 kW</td> <td>0</td> <td>200 µs</td> </tr> </tbody> </table> | | | | Motor Capacity | Default | Units | Converting to Time | 50 W to 750 W | 0 | 160 µs | 0 [ms] | 1 kW to 2 kW | 0 | 200 µs |
| Motor Capacity | Default | Units | Converting to Time | | | | | | | | | | | | |
| 50 W to 750 W | 0 | 160 µs | 0 [ms] | | | | | | | | | | | | |
| 1 kW to 2 kW | 0 | 200 µs | | | | | | | | | | | | | |
| Related To | No. 238.0 | | | | | | | | | | | | | | |
| No. 238.0 | Brake release: Delay time | Range 0 to 3,125 | Default (See below) | Characteristics | | | | | | | | | | | |
| Function Use | <p>This item indicates the delay time of the motor brake release signal (MBRK) ON after the motor excitation starts.</p> <p>By adjusting the timing to release the brake after the motor excitation starts, brake-equipped axes such as vertical axis can be prevented from roll back.</p> | | | | | | | | | | | | | | |
| | <table border="1"> <thead> <tr> <th>Motor Capacity</th> <th>Default</th> <th>Units</th> <th>Converting to Time</th> </tr> </thead> <tbody> <tr> <td>50 W to 750 W</td> <td>25</td> <td>160 µs</td> <td rowspan="2">4 [ms]</td> </tr> <tr> <td>1 kW to 2 kW</td> <td>20</td> <td>200 µs</td> </tr> </tbody> </table> | | | | Motor Capacity | Default | Units | Converting to Time | 50 W to 750 W | 25 | 160 µs | 4 [ms] | 1 kW to 2 kW | 20 | 200 µs |
| Motor Capacity | Default | Units | Converting to Time | | | | | | | | | | | | |
| 50 W to 750 W | 25 | 160 µs | 4 [ms] | | | | | | | | | | | | |
| 1 kW to 2 kW | 20 | 200 µs | | | | | | | | | | | | | |
| Related To | No. 237.0 | | | | | | | | | | | | | | |
| No. 239.0 | Quick stop: Deceleration time | Range 0 to 100 | Default 0 [ms] | Characteristics | | | | | | | | | | | |
| Function Use | <p>This item indicates decelerating time after a quick stop.</p> <p>Set the time-length for speed command to change from 1,000 [rpm] to 0 [rpm].</p> | | | | | | | | | | | | | | |
| Related To | No. 224.0, No. 232.2, No. 236.0 | | | | | | | | | | | | | | |

| | | | | |
|--|---|----------------|---|---|
| No. 257.0 | Absolute system Select | Settings | Default | Characteristics |
| | | 0 to 2 | 0 |      |
| Function Use | Select either Absolute system or Incremental system. | | | |
| | Settings | System | Multi-rotation counter Overflow detection | |
| | 0 | Incremental | - | |
| | 1 | Absolute | disable | |
| | 2 | Absolute | enable | |
| <p><u>Using this parameter in absolute systems</u></p> <ul style="list-style-type: none"> • Setting " 2" (this is the usual setting) Exceeding the encoder absolute value range of -4,294,967,296 to 4,294,967,295 (± 32,767 multi-turn data) will result in Alarm No.11 (encoder multi-turn counter overflow). If this happens, correct the command such that motion will be kept within the absolute value range. • Setting "1" Use this setting when absolute value of single-turn is needed for continuous turns only in one direction. Exceeding the encoder absolute value range will result in a position that is significantly off from the position specified by next command. Set Pulse Paired Ratio, so that the single-turn angle can be accurately detected with sufficient resolution even outside of the range. | | | | |
| No. 259.0 | Encoder: Overheat detection switch | Settings | Default | Characteristics |
| | | 0 to 2 | 0 |    -  |
| Function Use | Select operation when overheat of the encoder is detected. | | | |
| | Settings | Output | | |
| | 0 | No output | | |
| | 1 | Warning output | | |
| 2 | Alarm output | | | |
| No. 259.1 | Encoder: Battery voltage drop detection switch | Settings | Default | Characteristics |
| | | 0, 1 | 0 |    -  |
| Function Use | Select operation when encoder battery voltage drop is detected. | | | |
| | Settings | Output | | |
| | 0 | No output | | |
| | 1 | Warning output | | |

| | | | | |
|--------------|---|-----------------|---------------|---|
| No. 267.0 | Encoder: | Range | Default | Characteristics |
| | Overheat detection - Value | 0 to 127 | 85 [°C] |    -  |
| Function Use | Set the value to detect overheat of the encoder. (for reference only) | | | |
| Related To | No. 259.0 | | | |
| No. 268.0 | Encoder: | Range | Default | Characteristics |
| | Battery voltage drop detection - Value | 0 to 100 | 24 [0.1 V] |    -  |
| Function Use | Set the value to detect voltage drop of the encoder. | | | |
| Related To | No. 259.0 | | | |
| No. 272.1 | Encoder pulse output: | Settings | Default | Characteristics |
| | Rotational direction | 0, 1 | 0 |      |
| Function Use | Set the rotational direction of encoder pulse output. | | | |
| | This indicates the direction of counting pulses in ccw rotations. | | | |
| | Settings | In CCW rotation | | |
| | 0 | count down | | |
| 1 | count up | | | |
| Related To | No. 276.0, No. 278.0 | | | |

5. Parameters

| No. | Encoder pulse output: | Range | Default | Characteristics |
|-----------|---------------------------|-------------|----------------------|-----------------|
| No. 276.0 | Pulse ratio (numerator) | 1 to 65,535 | 1,000 [pulse/rev] | |
| No. 278.0 | Pulse ratio (denominator) | 1 to 65,535 | 8,000 [pulse/rev] | |

Set the encoder pulse output ratio with these two parameters.

Where the pulse count per rotation of host command and the pulse count per rotation of the motor do not agree,

$$\begin{aligned} \text{(numerator)} &= \text{(single-turn pulse count of host command)} / 4 \\ \text{(denominator)} &= \text{(single-turn pulse count of the motor)} / 4 = 32,768 \end{aligned}$$

$$\frac{\boxed{276.0}}{\boxed{278.0}} = \frac{\text{host command pulse count per rotation}}{\text{motor pulse count per rotation}} = \frac{\text{host command pulse count per rotation} / 4}{\text{motor pulse count per rotation} / 4}$$

Example Settings

Units: [pulse/rev]

Function Use

| A Host Command Pulse count per rotation | B Numerator No. 276.0 | C (①× 1/4) Denominator No. 278.0 |
|---|-----------------------------|--|
| 16,384 | 4,096 | 32,768 (=131,072 (*) / 4) |
| 10,000 | 2,500 | |
| 4,096 | 1,024 | |
| 4,000 | 1,000 | |









*) 131,072 is the pulse count per rotation of the motor.
The setting range of the ratio derived from these two parameters is 1/32,768 to 1.

The default setting values are assumed 16,384 pulses of the host command pulse number per a rotation.

If the Z-phase pulse width is too narrow to be measured accurately by the host controller, decrease this encoder pulse ratio or decrease the number of rotations to increase the pulse width. PLC normally requires approximately 1 ms pulse width.

$$\text{pulse width[ms]} = 2 \times \frac{60 \times 1,000}{\text{number of rotations [rpm]}} \times \frac{1}{\text{the paired-pulse ratio} \times 2^{17}}$$

| | |
|------------|---|
| Remark | <ul style="list-style-type: none"> Use these parameters within the max output frequency of 4 Mpps. Note that [Encoder output resolution] × [(Numerator)/(Denominator)] has to be a multiple of 4. |
| Related To | No. 34.0, No. 36.0, No. 272.1, No. 276.0, No. 278.0 |

| No. 285.0 | Encoder pulse output: Error detection - Frequency upper limit | Range | Default | Characteristics |
|--------------|---|-------------|----------------|---|
| | | 25 to 1,125 | 1,125 [kHz] |    -  |
| Function Use | Set the upper limit of the encoder pulse output frequency. Select an appropriate value according to the signal input specification from the host controller. | | | |
| Related To | No. 286.0 | | | |
| No. 286.0 | Encoder pulse output: Error detection - Delay time | Range | Default | Characteristics |
| | | 0 to 2,000 | 0 [ms] |    -  |
| Function Use | Set the detection delay time of encoder pulse output error. | | | |
| Related To | No. 285.0 | | | |

5. Parameters

| No. 288.0 | Analog torque: Input filter (numerator) | Range 0 to 65,535 | Default 16,000 | Characteristics | | | | | | | | | |
|--------------|---|----------------------|-------------------|-----------------|---------|------------------|------------------|---------|----------|--------|--------|--------|--------|
| No. 289.0 | Analog torque: Input filter (denominator) | 1 to 65,535 | 65,535 | | | | | | | | | | |
| Function Use | <p>Select values such that the <u>low-pass filter constant</u> will suppress the noise component of the Analog Torque Command input.</p> $\text{low-pass filter constant} = \frac{288.0}{289.0}$ <table border="1"> <thead> <tr> <th>Setting</th> <th>Noise Resistance</th> <th>Command Response</th> </tr> </thead> <tbody> <tr> <td>Smaller</td> <td>Stronger</td> <td>Slower</td> </tr> <tr> <td>Larger</td> <td>Weaker</td> <td>Faster</td> </tr> </tbody> </table> | | | | Setting | Noise Resistance | Command Response | Smaller | Stronger | Slower | Larger | Weaker | Faster |
| Setting | Noise Resistance | Command Response | | | | | | | | | | | |
| Smaller | Stronger | Slower | | | | | | | | | | | |
| Larger | Weaker | Faster | | | | | | | | | | | |
| Prerequisite | Analog torque: Input filter switch (302.1) = 1 (Enable) | | | | | | | | | | | | |
| Remark | The ratio of No.288.0 (numerator) to No.289.0 (denominator) must be below 1. Filtering will not take effect if the ratio is 1. | | | | | | | | | | | | |
| Related To | No. 302.1 | | | | | | | | | | | | |

| | | | | |
|-----------|--|----------------------|-----------------------------------|-----------------|
| No. 290.0 | Analog torque: Input gain (numerator) | Range 0 to 65,535 | Default (See below) [0.1 %] | Characteristics |
| No. 291.0 | Analog torque: Input gain (denominator) | 1 to 65,535 | | |



Set the gain of analog torque command input.

With these two parameters, you can adjust the gain of the host controller. The motor torque is max when (numerator)/(denominator)=1 and analog command voltage (± 10 V) input.

$$\text{command Input Gain} = \frac{290.0}{291.0}$$

The figures in the table below are applicable for both numerator and denominator.

| Function Use | MA, MM, and MH Series | | MX, MY, and MZ Series | |
|--------------|-----------------------|----------------------------------|-----------------------|----------------------------------|
| | Motor Capacity | No. 290.0, and No. 291.0 Default | Motor Capacity | No. 290.0, and No. 291.0 Default |
| | 50 W | 3,500 | 50 W | 3,500 |
| | 100 W | 3,500 | 100 W | 3,400 |
| | 200 W | 3,100 | 200 W | 3,100 |
| | 400 W | 3,000 | 400 W | 3,100 |
| | 750 W | 3,000 | 750 W | 2,900 |
| | 1 kW | 3,300 | 1 kW | 3,000 |
| | 1.5 kW | 3,200 | | |
| | 2 kW | 3,100 | | |













| No. | Parameter Name | Range | Default | Characteristics |
|--------------|---|-------------|------------------------|---|
| No. 292.0 | Analog torque: CCW torque limit (numerator) | 0 to 65,535 | (See below) [0.1 %] |  |
| No. 293.0 | Analog torque: CCW torque limit (denominator) | 1 to 65,535 | | |
| Function Use | Set the CCW torque limit of analog torque command. CCW torque limit = Instantaneous maximum torque $\frac{\boxed{292.0}}{\boxed{293.0}}$ | | | |
| Related To | No. 294.0, No. 295.0 | | | |
| No. | Parameter Name | Range | Default | Characteristics |
| No. 294.0 | Analog torque: CW torque limit (numerator) | 0 to 65,535 | (See below) [0.1 %] |  |
| No. 295.0 | Analog torque: CW torque limit (denominator) | 1 to 65,535 | | |
| Function Use | Set the CW torque limit of analog torque command. CW torque limit = Instantaneous maximum torque $\frac{\boxed{294.0}}{\boxed{295.0}}$ | | | |
| Related To | No. 292.0, No. 293.0 | | | |



Default values of parameters No.292.0, 293.0, 294.0. and 295.0

The figures in the table below are applicable for both numerator and denominator.

| MA, MM, and MH Series Motor Capacity | | Default | MX, MY, and MZ Series Motor Capacity | | Default |
|---|-------|---------|---|-------|---------|
| 50 W | 3,500 | | 50 W | 3,500 | |
| 100 W | 3,500 | | 100 W | 3,400 | |
| 200 W | 3,100 | | 200 W | 3,100 | |
| 400 W | 3,000 | | 400 W | 3,100 | |
| 750 W | 3,000 | | 750W | 2,900 | |
| 1 kW | 3,300 | | 1 kW | 3,000 | |
| 1.5 kW | 3,200 | | | | |
| 2 kW | 3,100 | | | | |

5. Parameters

| No. 300.0 | Analog torque: Offset value | Range | Default | Characteristics | | | | | | | | | |
|--------------|--|------------------------|---------|---|----------|------------------------|------------------------|---------|--------------|-------------|---|-------------|--------------|
| | | - 32,768 to +32,767 | 0 |    -  | | | | | | | | | |
| Function Use | <p>Adjust this parameter such that analog command value = 0 % when the drive is configured for analog command and input voltage is 0 V.</p> <p><u>Setup Procedure</u></p> <ol style="list-style-type: none"> ① Use Analog torque speed limit (152.0) to set the value of a speed limit to a reasonable rotational speed such as 1,000 rpm. ② Set the analog voltage of the host controller to 0 V. ③ Turn the servo ON. (If the offset is misaligned, the motor will rotate.) ④ Select a value for the offset observing the torque command value. | | | | | | | | | | | | |
| Prerequisite | Analog speed command: Offset tuning method (302.2) = 1 (Manual tuning) | | | | | | | | | | | | |
| Remark | Adjust this parameter with the motor alone. Never adjust it while the motor is installed in any equipment. | | | | | | | | | | | | |
| Related To | No. 302.2 | | | | | | | | | | | | |
| No. 302.0 | Analog torque: Direction of rotation | Settings | Default | Characteristics | | | | | | | | | |
| | | 0, 1 | 1 |    -  | | | | | | | | | |
| Function Use | <p>Specify the rotational direction of analog torque command input.</p> <table border="1"> <thead> <tr> <th>Settings</th> <th>Negative Voltage Input</th> <th>Positive Voltage Input</th> </tr> </thead> <tbody> <tr> <td>0</td> <td>CCW Rotation</td> <td>CW Rotation</td> </tr> <tr> <td>1</td> <td>CW Rotation</td> <td>CCW Rotation</td> </tr> </tbody> </table> | | | | Settings | Negative Voltage Input | Positive Voltage Input | 0 | CCW Rotation | CW Rotation | 1 | CW Rotation | CCW Rotation |
| Settings | Negative Voltage Input | Positive Voltage Input | | | | | | | | | | | |
| 0 | CCW Rotation | CW Rotation | | | | | | | | | | | |
| 1 | CW Rotation | CCW Rotation | | | | | | | | | | | |
| No. 302.1 | Analog torque: Input filter enable switch | Settings | Default | Characteristics | | | | | | | | | |
| | | 0, 1 | 1 |    -  | | | | | | | | | |
| Function Use | <p>Enable/Disable Analog torque command input filter.</p> <p>Enable if noise is significant in the analog command.</p> <table border="1"> <thead> <tr> <th>Settings</th> <th>Input filter switch</th> </tr> </thead> <tbody> <tr> <td>0</td> <td>Disable</td> </tr> <tr> <td>1</td> <td>Enable</td> </tr> </tbody> </table> | | | | Settings | Input filter switch | 0 | Disable | 1 | Enable | | | |
| Settings | Input filter switch | | | | | | | | | | | | |
| 0 | Disable | | | | | | | | | | | | |
| 1 | Enable | | | | | | | | | | | | |

| | | | | |
|--------------|---|---|--|---|
| No. 302.2 | Analog torque: Offset tuning method | Settings | Default | Characteristics |
| | | 0, 1 | 1 |  |
| Function Use | Specify the offset tuning method for Analog Velocity command. | | | |
| | Settings | Tuning Method | Description | |
| | 0 | Auto Tuning | Automatically adjust the offset value such that torque command=0 % at the input voltage at the time of servo on. | |
| 1 | Manual Tuning | Manually adjust the offset value such that torque command=0 % at 0 V input voltage. | | |
| No. 305.0 | Voltage dip Detection: Delay time | Range | Default | Characteristics |
| | | 20 to 50,000 | 80 [ms] |  |
| Function Use | Set the delay time to the required voltage dip detection time of the AC supply. | | | |
| Remark | Detection of a voltage dip will result in Alarm No.15. Set this parameter suitable to your operating conditions. | | | |

5. Parameters

| | | | | |
|--------------|--|-------------|----------------|-----------------|
| No. 357.0 | Position command filter 3: Notch frequency | Range | Default | Characteristics |
| | | 10 to 2,000 | 10 [0.1 Hz] | |
| Function Use | Set the <u>notch frequency</u> for Position Command Filter 3. | | | |
| Prerequisite | Position command filter 3: Type (82.1) = 2 (Notch) or 3 (γ -Notch) | | | |
| Related To | No. 82.1, No. 358.0, No. 359.0, No. 360.0 | | | |

7 Tuning

| | | | | |
|--------------|---|--------------|---------|-----------------|
| No. 358.0 | Position command filter 3: Notch width | Range | Default | Characteristics |
| | | 128 to 2,048 | 512 | |
| Function Use | Set the <u>width of notch</u> of Position Command Filter 3. | | | |
| Function Use | Setting | Notch Width | | |
| | smaller | narrower | | |
| | larger | wider | | |
| Prerequisite | Position command filter 3: Type (82.1) = 2 (Notch) | | | |
| Related To | No. 82.1, No. 357.0, No. 360.0 | | | |

7 Tuning

| | | | | |
|--|---|-----------|---------|-----------------|
| No. 359.0 | Position command filter 3: High frequency gain | Range | Default | Characteristics |
| | | 50 to 200 | 100 | |
| Function Use | Set the <u>high frequency gain</u> for Position Command Filter 3. | | | |
| Function Use | Setting | Effect | | |
| | 50 | x0.25 | | |
| | 100 | x1 | | |
| | 200 | x4 | | |
| Smaller setting value gives better vibration suppression. Larger setting value gives faster motion. | | | | |
| Prerequisite | Position command filter 3: Type (82.1) = 3 (γ -Notch) | | | |
| Related To | No. 82.1, No. 357.0, No. 360.0 | | | |













7 Tuning

| | | | | |
|--|--|---|---------|-----------------|
| No. 360.0 | Position command filter 3: Notch depth | Range | Default | Characteristics |
| | | 0 to 100 | 0 | |
| Function Use | Set the <u>depth</u> for Position Command Filter 3. | | | |
| Function Use | Setting | Notch Depth | | |
| | 0 | complete shutoff of notch frequency input | | |
| | 100 | 100 % pass-through | | |
| Smaller setting value gives deeper filter. Larger setting value gives shallower filter. | | | | |
| Prerequisite | Position command filter 3: Type (82.1) = 2 (Notch) or 3 (γ -Notch) | | | |
| Related To | No. 82.1, No. 357.0, No. 358.0, No. 359.0 | | | |

7 Tuning

| No. 363.0 | Position error warning detection: Value | Range | Default | Characteristics | | | | | | | | | | | |
|--|--|---|--------------------------------|---|-------------------|----------------------------|-------|--------------|---------|-----------------------------------|-------|-------------|--|--|--|
| | | 0 to 2,147,483,647 | 100 [pulse] |    -  | | | | | | | | | | | |
| Function Use | Set the value to determine the position error warning level. The position error warning will be detected when the position error exceeds this parameter value. | | | | | | | | | | | | | | |
| Prerequisite | Position error detection: Switch (65.0) = 2 (Warning output), or 3 (Alarm and Warning output) | | | | | | | | | | | | | | |
| Related To | No. 65.0, No. 365.0 | | | | | | | | | | | | | | |
| No. 365.0 | Position error warning detection: Delay time | Range | Default | Characteristics | | | | | | | | | | | |
| | | 0 to 65,535 | (See below) |    -  | | | | | | | | | | | |
| Function Use | Set the delay time to determine the position error warning detection time. | | | | | | | | | | | | | | |
| | <table border="1"> <thead> <tr> <th>Motor Capacity</th> <th>Default</th> <th>Units</th> <th>Converted to Time</th> </tr> </thead> <tbody> <tr> <td>50 W to 750 W</td> <td>250</td> <td>160 μs</td> <td rowspan="2">40 [ms]</td> </tr> <tr> <td>1 kW to 2 kW</td> <td>200</td> <td>200 μs</td> </tr> </tbody> </table> | Motor Capacity | Default | Units | Converted to Time | 50 W to 750 W | 250 | 160 μ s | 40 [ms] | 1 kW to 2 kW | 200 | 200 μ s | | | |
| Motor Capacity | Default | Units | Converted to Time | | | | | | | | | | | | |
| 50 W to 750 W | 250 | 160 μ s | 40 [ms] | | | | | | | | | | | | |
| 1 kW to 2 kW | 200 | 200 μ s | | | | | | | | | | | | | |
| Prerequisite | Position error detection: Switch (65.0) = 2 (Warning output), or 3 (Alarm and Warning output) | | | | | | | | | | | | | | |
| Related To | No. 65.0, No. 363.0 | | | | | | | | | | | | | | |
| No. 385.0 | JOG operation: Acceleration time | Range | Default | Characteristics | | | | | | | | | | | |
| | | 0 to 60,000 | 1,000 [ms] |    -  | | | | | | | | | | | |
| Function Use | Set the acceleration time for JOG operation. This item indicates the amount of time for a speed command to change from 0 rpm to 1,000 rpm. With the default setting, it takes the rotational speed 3,000 ms to reach 3,000 rpm. | | | | | | | | | | | | | | |
| Related To | JOG operation requires control power supply and the Servo ON signal input from the I/O connector. | | | | | | | | | | | | | | |
| No. 386.0 | JOG operation: Deceleration time | Range | Default | Characteristics | | | | | | | | | | | |
| | | 0 to 60,000 | 1,000 [ms] |    -  | | | | | | | | | | | |
| Function Use | Set the deceleration time for JOG operation. This item indicates the amount of time for a speed command to change from 1,000 rpm to 0 rpm. With the default setting, when the motor is rotating at 3,000 [rpm], it takes 3,000 [ms] to stop. | | | | | | | | | | | | | | |
| Remark | JOG operation requires control power supply and the Servo ON signal input from the I/O connector. | | | | | | | | | | | | | | |
| No. 387.0 | JOG operation: Target speed | Range | Default | Characteristics | | | | | | | | | | | |
| | | 0 to Maximum Rotational Speed of Motor | 300 [rpm] |    -  | | | | | | | | | | | |
| Function Use | Set the target speed for JOG operation. | | | | | | | | | | | | | | |
| | <table border="1"> <thead> <tr> <th>Motor Model</th> <th>Maximum rotational speed [rpm]</th> </tr> </thead> <tbody> <tr> <td>MM500, MY500, MM101, MY101, MX201, MZ201, MX401, MZ401, MX751, MZ751</td> <td>6,000</td> </tr> <tr> <td>MA201, MH201, MA401, MH401</td> <td>5,000</td> </tr> <tr> <td>MA751, MH751</td> <td>4,500</td> </tr> <tr> <td>MM102, MH102, MM152, MH152, MM202</td> <td>3,000</td> </tr> </tbody> </table> | Motor Model | Maximum rotational speed [rpm] | MM500, MY500, MM101, MY101, MX201, MZ201, MX401, MZ401, MX751, MZ751 | 6,000 | MA201, MH201, MA401, MH401 | 5,000 | MA751, MH751 | 4,500 | MM102, MH102, MM152, MH152, MM202 | 3,000 | | | | |
| Motor Model | Maximum rotational speed [rpm] | | | | | | | | | | | | | | |
| MM500, MY500, MM101, MY101, MX201, MZ201, MX401, MZ401, MX751, MZ751 | 6,000 | | | | | | | | | | | | | | |
| MA201, MH201, MA401, MH401 | 5,000 | | | | | | | | | | | | | | |
| MA751, MH751 | 4,500 | | | | | | | | | | | | | | |
| MM102, MH102, MM152, MH152, MM202 | 3,000 | | | | | | | | | | | | | | |
| Remark | JOG operation requires control power supply and the Servo ON signal input from the I/O connector. | | | | | | | | | | | | | | |

5. Parameters



| | | | | |
|--------------|--|-----------------------------------|------------|---|
| No. 388.0 | Internal velocity: Command method | Settings | Default | Characteristics |
| | | 0, 1 | 0 |    -  |
| Function Use | Select the type of Internal Velocity Command. | | | |
| | Settings | Method | | |
| | 0 | Zero command | | |
| | 1 | Preset speed command (8 settings) | | |
| Prerequisite | The following two settings are necessary. <ul style="list-style-type: none"> Control Mode (2.0) = 1 (Velocity control mode) Command Mode (3.0) = 3 (Internal command mode) | | | |
| Related To | No. 2.0, No. 3.0, No. 390.0, No. 391.0, No. 392.0 to 399.0 | | | |
| No. 390.0 | Internal velocity: Acceleration time | Range | Default | Characteristics |
| | | 0 to 60,000 | 1,000 [ms] |    -  |
| Function Use | Set the acceleration time for internal velocity command to change the speed. | | | |
| | This item indicates the amount of time for a speed command to change from 0 rpm to 1,000 rpm. With the default setting, it takes the rotational speed 3,000 [ms] to reach 3,000 [rpm]. | | | |
| Prerequisite | The following three settings are necessary. <ul style="list-style-type: none"> Control Mode (2.0) = 1 (Velocity control mode) Command Mode (3.0) = 3 (Internal command mode) Internal Velocity: Command Method (388.0) = 1 (Preset speed command) | | | |
| Related To | No. 388.0, No. 391.0, No. 392.0 to 399.0 | | | |
| No. 391.0 | Internal velocity: Deceleration time | Range | Default | Characteristics |
| | | 0 to 60,000 | 1,000 [ms] |    -  |
| Function Use | Set the deceleration time for internal velocity command to change the speed. | | | |
| | This item indicates the amount of time for a speed command to change from 0 rpm to 1,000 rpm. With the default setting, it takes the rotational speed 3,000 [ms] to reach 3,000 [rpm]. | | | |
| Prerequisite | The following three settings are necessary. <ul style="list-style-type: none"> Control Mode (2.0) = 1 (Velocity control mode) Command Mode (3.0) = 3 (Internal command mode) Internal Velocity: Command Method (388.0) = 1 (Preset speed command) | | | |
| Related To | No. 388.0, No. 391.0, No. 392.0 to 399.0 | | | |

| No. 392.0 to No. 399.0 | Internal velocity: | Range | Default | Characteristics | | | | | | | | | | | | | | | | | | | | | | | | | | | | | | | | | | | | | | | | | | | | | | | | | | | | | | | | | | | | | | | | | | | | | | | | | |
|------------------------------|--|--|--|-----------------|---------------|--------------|----------------|--|-------------|--------------|-------|---|-----|--|-------|---|-------|--|-------|---|-------|--|-------|---|-------|--|-------|---|-------|--|-------|---|-------|--|-------|---|-------|-------|-------|---|--------------------------------|--|--------------|--------------------|--------------------|---------------------|---|-------------------------------------|-------------------------------------|-------------------------------------|---|--|-------------------------------------|-------------------------------------|---|-------------------------------------|--|-------------------------------------|---|--|--|-------------------------------------|---|-------------------------------------|-------------------------------------|--|---|--|-------------------------------------|--|---|-------------------------------------|--|--|---|--|--|
| | Preset speed 1 to 8 | 0 to Motor max rotational speed | (See below) [rpm] | | | | | | | | | | | | | | | | | | | | | | | | | | | | | | | | | | | | | | | | | | | | | | | | | | | | | | | | | | | | | | | | | | | | | | | | | | |
| Function Use | Select one of 8 levels for target speed of Internal velocity command input. | | | | | | | | | | | | | | | | | | | | | | | | | | | | | | | | | | | | | | | | | | | | | | | | | | | | | | | | | | | | | | | | | | | | | | | | | | | | |
| | <p>Default Units: [rpm]</p> <table border="1"> <thead> <tr> <th rowspan="2">Parameter No.</th> <th rowspan="2">Target Speed</th> <th colspan="2">Motor Capacity</th> </tr> <tr> <th>50 W- 750 W</th> <th>1 kW to 2 kW</th> </tr> </thead> <tbody> <tr><td>392.0</td><td>1</td><td colspan="2">500</td></tr> <tr><td>393.0</td><td>2</td><td colspan="2">1,000</td></tr> <tr><td>394.0</td><td>3</td><td colspan="2">1,500</td></tr> <tr><td>395.0</td><td>4</td><td colspan="2">2,000</td></tr> <tr><td>396.0</td><td>5</td><td colspan="2">2,500</td></tr> <tr><td>397.0</td><td>6</td><td colspan="2">3,000</td></tr> <tr><td>398.0</td><td>7</td><td>4,000</td><td>3,000</td></tr> <tr><td>399.0</td><td>8</td><td colspan="2">Motor Max Rotational Speed (*)</td></tr> </tbody> </table> <p>Combination of Pin No.8, 9, and 10 of I/O connector (CN1)</p> <table border="1"> <thead> <tr> <th>Target Speed</th> <th>Pin No. 8 (VCSEL1)</th> <th>Pin No. 9 (VCSEL2)</th> <th>Pin No. 10 (VCSEL3)</th> </tr> </thead> <tbody> <tr><td>1</td><td><input type="button" value="Open"/></td><td><input type="button" value="Open"/></td><td><input type="button" value="Open"/></td></tr> <tr><td>2</td><td><input checked="" type="button" value="Closed"/></td><td><input type="button" value="Open"/></td><td><input type="button" value="Open"/></td></tr> <tr><td>3</td><td><input type="button" value="Open"/></td><td><input checked="" type="button" value="Closed"/></td><td><input type="button" value="Open"/></td></tr> <tr><td>4</td><td><input checked="" type="button" value="Closed"/></td><td><input checked="" type="button" value="Closed"/></td><td><input type="button" value="Open"/></td></tr> <tr><td>5</td><td><input type="button" value="Open"/></td><td><input type="button" value="Open"/></td><td><input checked="" type="button" value="Closed"/></td></tr> <tr><td>6</td><td><input checked="" type="button" value="Closed"/></td><td><input type="button" value="Open"/></td><td><input checked="" type="button" value="Closed"/></td></tr> <tr><td>7</td><td><input type="button" value="Open"/></td><td><input checked="" type="button" value="Closed"/></td><td><input checked="" type="button" value="Closed"/></td></tr> <tr><td>8</td><td><input checked="" type="button" value="Closed"/></td><td><input checked="" type="button" value="Closed"/></td><td><input checked="" type="button" value="Closed"/></td></tr> </tbody> </table> <p><input checked="" type="button" value="Closed"/> : Contact with COM- <input type="button" value="Open"/> : No contact with COM-</p> <p>The direction of rotation (CCW/CW) controls with No.6 pins (VCRUN1) and No.7 pins (VCRUN2) of I/O.</p> | | | | Parameter No. | Target Speed | Motor Capacity | | 50 W- 750 W | 1 kW to 2 kW | 392.0 | 1 | 500 | | 393.0 | 2 | 1,000 | | 394.0 | 3 | 1,500 | | 395.0 | 4 | 2,000 | | 396.0 | 5 | 2,500 | | 397.0 | 6 | 3,000 | | 398.0 | 7 | 4,000 | 3,000 | 399.0 | 8 | Motor Max Rotational Speed (*) | | Target Speed | Pin No. 8 (VCSEL1) | Pin No. 9 (VCSEL2) | Pin No. 10 (VCSEL3) | 1 | <input type="button" value="Open"/> | <input type="button" value="Open"/> | <input type="button" value="Open"/> | 2 | <input checked="" type="button" value="Closed"/> | <input type="button" value="Open"/> | <input type="button" value="Open"/> | 3 | <input type="button" value="Open"/> | <input checked="" type="button" value="Closed"/> | <input type="button" value="Open"/> | 4 | <input checked="" type="button" value="Closed"/> | <input checked="" type="button" value="Closed"/> | <input type="button" value="Open"/> | 5 | <input type="button" value="Open"/> | <input type="button" value="Open"/> | <input checked="" type="button" value="Closed"/> | 6 | <input checked="" type="button" value="Closed"/> | <input type="button" value="Open"/> | <input checked="" type="button" value="Closed"/> | 7 | <input type="button" value="Open"/> | <input checked="" type="button" value="Closed"/> | <input checked="" type="button" value="Closed"/> | 8 | <input checked="" type="button" value="Closed"/> | <input checked="" type="button" value="Closed"/> |
| Parameter No. | Target Speed | Motor Capacity | | | | | | | | | | | | | | | | | | | | | | | | | | | | | | | | | | | | | | | | | | | | | | | | | | | | | | | | | | | | | | | | | | | | | | | | | | | |
| | | 50 W- 750 W | 1 kW to 2 kW | | | | | | | | | | | | | | | | | | | | | | | | | | | | | | | | | | | | | | | | | | | | | | | | | | | | | | | | | | | | | | | | | | | | | | | | | | |
| 392.0 | 1 | 500 | | | | | | | | | | | | | | | | | | | | | | | | | | | | | | | | | | | | | | | | | | | | | | | | | | | | | | | | | | | | | | | | | | | | | | | | | | | |
| 393.0 | 2 | 1,000 | | | | | | | | | | | | | | | | | | | | | | | | | | | | | | | | | | | | | | | | | | | | | | | | | | | | | | | | | | | | | | | | | | | | | | | | | | | |
| 394.0 | 3 | 1,500 | | | | | | | | | | | | | | | | | | | | | | | | | | | | | | | | | | | | | | | | | | | | | | | | | | | | | | | | | | | | | | | | | | | | | | | | | | | |
| 395.0 | 4 | 2,000 | | | | | | | | | | | | | | | | | | | | | | | | | | | | | | | | | | | | | | | | | | | | | | | | | | | | | | | | | | | | | | | | | | | | | | | | | | | |
| 396.0 | 5 | 2,500 | | | | | | | | | | | | | | | | | | | | | | | | | | | | | | | | | | | | | | | | | | | | | | | | | | | | | | | | | | | | | | | | | | | | | | | | | | | |
| 397.0 | 6 | 3,000 | | | | | | | | | | | | | | | | | | | | | | | | | | | | | | | | | | | | | | | | | | | | | | | | | | | | | | | | | | | | | | | | | | | | | | | | | | | |
| 398.0 | 7 | 4,000 | 3,000 | | | | | | | | | | | | | | | | | | | | | | | | | | | | | | | | | | | | | | | | | | | | | | | | | | | | | | | | | | | | | | | | | | | | | | | | | | |
| 399.0 | 8 | Motor Max Rotational Speed (*) | | | | | | | | | | | | | | | | | | | | | | | | | | | | | | | | | | | | | | | | | | | | | | | | | | | | | | | | | | | | | | | | | | | | | | | | | | | |
| Target Speed | Pin No. 8 (VCSEL1) | Pin No. 9 (VCSEL2) | Pin No. 10 (VCSEL3) | | | | | | | | | | | | | | | | | | | | | | | | | | | | | | | | | | | | | | | | | | | | | | | | | | | | | | | | | | | | | | | | | | | | | | | | | | |
| 1 | <input type="button" value="Open"/> | <input type="button" value="Open"/> | <input type="button" value="Open"/> | | | | | | | | | | | | | | | | | | | | | | | | | | | | | | | | | | | | | | | | | | | | | | | | | | | | | | | | | | | | | | | | | | | | | | | | | | |
| 2 | <input checked="" type="button" value="Closed"/> | <input type="button" value="Open"/> | <input type="button" value="Open"/> | | | | | | | | | | | | | | | | | | | | | | | | | | | | | | | | | | | | | | | | | | | | | | | | | | | | | | | | | | | | | | | | | | | | | | | | | | |
| 3 | <input type="button" value="Open"/> | <input checked="" type="button" value="Closed"/> | <input type="button" value="Open"/> | | | | | | | | | | | | | | | | | | | | | | | | | | | | | | | | | | | | | | | | | | | | | | | | | | | | | | | | | | | | | | | | | | | | | | | | | | |
| 4 | <input checked="" type="button" value="Closed"/> | <input checked="" type="button" value="Closed"/> | <input type="button" value="Open"/> | | | | | | | | | | | | | | | | | | | | | | | | | | | | | | | | | | | | | | | | | | | | | | | | | | | | | | | | | | | | | | | | | | | | | | | | | | |
| 5 | <input type="button" value="Open"/> | <input type="button" value="Open"/> | <input checked="" type="button" value="Closed"/> | | | | | | | | | | | | | | | | | | | | | | | | | | | | | | | | | | | | | | | | | | | | | | | | | | | | | | | | | | | | | | | | | | | | | | | | | | |
| 6 | <input checked="" type="button" value="Closed"/> | <input type="button" value="Open"/> | <input checked="" type="button" value="Closed"/> | | | | | | | | | | | | | | | | | | | | | | | | | | | | | | | | | | | | | | | | | | | | | | | | | | | | | | | | | | | | | | | | | | | | | | | | | | |
| 7 | <input type="button" value="Open"/> | <input checked="" type="button" value="Closed"/> | <input checked="" type="button" value="Closed"/> | | | | | | | | | | | | | | | | | | | | | | | | | | | | | | | | | | | | | | | | | | | | | | | | | | | | | | | | | | | | | | | | | | | | | | | | | | |
| 8 | <input checked="" type="button" value="Closed"/> | <input checked="" type="button" value="Closed"/> | <input checked="" type="button" value="Closed"/> | | | | | | | | | | | | | | | | | | | | | | | | | | | | | | | | | | | | | | | | | | | | | | | | | | | | | | | | | | | | | | | | | | | | | | | | | | |
| Prerequisite | The following three settings are necessary. <ul style="list-style-type: none"> • Control Mode (2.0) = 1 (Velocity control mode) • Command Mode (3.0) = 3 (Internal command mode) • Internal Velocity: Command Method (388.0) = 1 (Preset speed command) | | | | | | | | | | | | | | | | | | | | | | | | | | | | | | | | | | | | | | | | | | | | | | | | | | | | | | | | | | | | | | | | | | | | | | | | | | | | |
| Related To | No. 388.0, No. 390.0, No. 391.0 | | | | | | | | | | | | | | | | | | | | | | | | | | | | | | | | | | | | | | | | | | | | | | | | | | | | | | | | | | | | | | | | | | | | | | | | | | | | |

*) Maximum rotational speed of motor

| Motor Model | Maximum rotational speed [rpm] |
|---|--------------------------------|
| MM500, MY500, MM101, MY101, MX201, MZ201, MX401, MZ401, MX751, MZ751, | 6,000 |
| MA201, MH201, MA401, MH401 | 5,000 |
| MA751, MH751 | 4,500 |
| MM102, MH102, MM152, MH152, MM202 | 3,000 |

5. Parameters

| | | | | |
|--------------|---|--------------------------------|---------|---|
| No. 642.0 | Internal position: Operation mode | Settings | Default | Characteristics |
| | | 0, 1 | 0 |  |
| Function Use | Set the operation mode for <u>Position Control Mode (internal command)</u> . | | | |
| | Settings | Operation Mode | | |
| | 0 | Point Table | | |
| | 1 | Testing (Communication motion) | | |
| Prerequisite | The following two settings are necessary. <ul style="list-style-type: none"> Control Mode (2.0) = 0 (Position Control Mode) Command Mode (3.0) = 3 (Internal command mode) | | | |
| Related To | No. 2.0, No. 3.0 | | | |
| No. 643.0 | Internal position: Overflow detection | Settings | Default | Characteristics |
| | | 0, 1 | 0 |  |
| Function Use | Enable/Disable the multiturn encoder counter overflow detection function for <u>Positioner Drive using ABS value</u> . This function is a protective measure against absolute position loss of the encoder. | | | |
| | If Internal Position Command exceeds the absolute value range ($\pm 1,073,741,823$), or shift amount per one command exceeds the range ($\pm 2,147,487,647$), overflow will be detected, resulting in Alarm No.10. | | | |
| | Settings | Overflow Detection | | |
| | 0 | Disable (*1) | | |
| | 1 | Enable (*2) | | |
| | <p>*1) For repeating rotations only in one direction, when you need absolute value of single-turn angle, set Absolute system (257.0) = 1 (Multi-turn counter overflow detection disabled)</p> <p>*2) When you set Absolute system (257.0) = 2 (Multi-rotation counter overflow detection enabled), Alarm No.11 occurs if multi-turn data exceeds the rated range ($\pm 32,767$). Select a value for internal position command not larger than the rated value.</p> | | | |
| | “Absolute Value” Operation using Positioner, and Testing | | | |
| | Set this parameter to 0 and the command method for point table to “relative value” . Setting “absolute value” will result in Alarm No.10. When the setting was changed from 0 to 1, perform homing. | | | |
| Related To | No. 257.0 | | | |

| | | | | |
|--------------|---|---|---------|-----------------|
| No. 644.0 | Internal position: Point table - Point number output method | Settings | Default | Characteristics |
| | | 0 to 2 | 1 | |
| Function Use | Select the output timing for a point number (PM1...3) when using I/O assignment Option1 for Positioner Drive. | | | |
| | Settings | Output timing for Motion Start Point Number | | |
| | 0 | Upon motion start | | |
| | 1 | Upon motion complete | | |
| | 2 | Upon motion start of each point | | |
| Prerequisite | The following two settings are necessary. <ul style="list-style-type: none"> Control Mode (2.0) = 0 (Position Control Mode) Command Mode (3.0) = 3 (Internal command mode/Option I/O Setting) | | | |



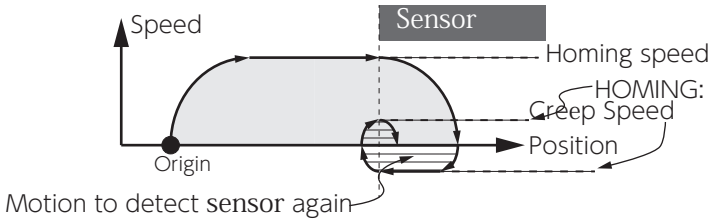

| | | | | |
|--------------|--|-----------------------------|---------|-----------------|
| No. 645.0 | Homing: Home reference signal selection | Settings | Default | Characteristics |
| | | 0 to 2 | 2 | |
| Function Use | Select the signal that the home position will be referenced to. | | | |
| | Settings | Reference Signal 1 | | |
| | 0 | Any user specified position | | |
| | 1 | Stopper | | |
| | 2 | Home-sensor-front-end (*) | | |
| | *) Starting point is located on the sensor Regardless of the Re-detection of Home position sensor (645.3) setting, this setting indicates a motion of at first moving backward to a position where homing can be performed. | | | |
| | | | | |

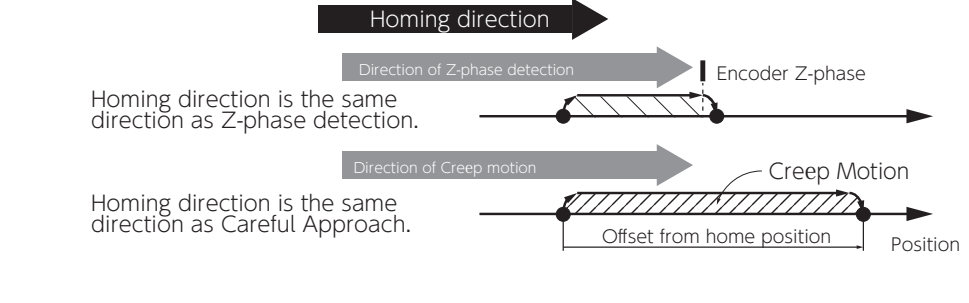
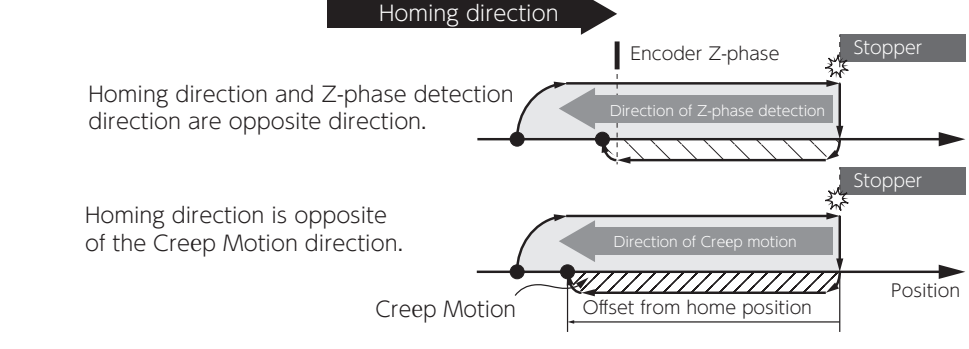
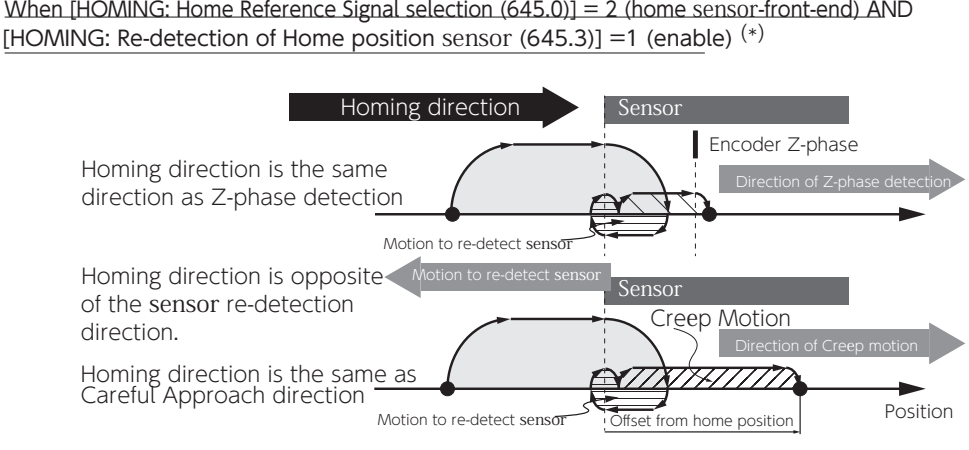
| | | | | |
|--------------|--|-----------------|---------|-----------------|
| No. 645.1 | Homing: Encoder Z-phase selection | Settings | Default | Characteristics |
| | | 0, 1 | 1 | |
| Function Use | To add encoder Z-phase as the reference position after the Home Reference Signal is detected, set this parameter to 1. | | | |
| | Settings | Encoder Z-phase | | |
| | 0 | Disable | | |
| | 1 | Enable | | |

| | | | | |
|--|--|---------------------|---------|---|
| No. 645.3 | Homing: | Settings | Default | Characteristics |
| | Re-detection of home position sensor | 0, 1 | 0 |  |
| Function Use | <p>Use this parameter, after detecting sensor-front-end, to re-detect the sensor-front-end at a speed specified with the homing creep speed parameter.</p> | | | |
| | Settings | Re-detecting motion | | |
| | 0 | Disable | | |
| 1 | Enable | | | |
|  | | | | |
| Prerequisite | Homing: Home reference signal selection (645.0) : 2 (home sensor-front-end) | | | |

| No. 646.0 | Homing: Direction | Settings 0, 1 | Default 0 | Characteristics  | | | | | | |
|--|--|------------------|--------------|--|----------|-----------------------|---|-----|---|----|
| Specify the homing direction. | | | | | | | | | | |
| <table border="1"> <thead> <tr> <th>Settings</th> <th>Direction of rotation</th> </tr> </thead> <tbody> <tr> <td>0</td> <td>CCW</td> </tr> <tr> <td>1</td> <td>CW</td> </tr> </tbody> </table> | | | | | Settings | Direction of rotation | 0 | CCW | 1 | CW |
| Settings | Direction of rotation | | | | | | | | | |
| 0 | CCW | | | | | | | | | |
| 1 | CW | | | | | | | | | |
| When [HOMING: Home Reference Signal selection (645.0)] = 0 (Any user specified position) | | | | | | | | | | |
|  | | | | | | | | | | |
| When [HOMING: Home Reference Signal selection (645.0)] = 1 (Stopper) | | | | | | | | | | |
|  | | | | | | | | | | |
| Function Use | When [HOMING: Home Reference Signal selection (645.0)] = 2 (home sensor-front-end) AND [HOMING: Re-detection of Home position sensor (645.3)] = 1 (enable) (*) | | | | | | | | | |
| |  | | | | | | | | | |
| | *) If the starting point is on the sensor, the motion is automatically in the reverse direction of homing, and then the sensor-front-end is detected upon machine's leaving the sensor | | | | | | | | | |
| Related To | No. 645.0, No. 645.1, No. 645.3 | | | | | | | | | |

5. Parameters

| No. 646.1 | Homing: Sensor polarity | Settings 0, 1 | Default 0 | Characteristics  | | | | | | |
|--------------|--|------------------|--------------|--|----------|----------------------|---|----------------------|---|------------------------|
| Function Use | <p>Select the polarity for the home sensor signal input ORG (Pin No.11) of CN1 to detect the sensor-front-end.</p> <table border="1" data-bbox="387 510 1297 618"> <thead> <tr> <th>Settings</th> <th>Detection Polarity</th> </tr> </thead> <tbody> <tr> <td>0</td> <td>Detect where ORG=OFF</td> </tr> <tr> <td>1</td> <td>Detect where ORG=ON</td> </tr> </tbody> </table> <p>■ 0 (Detect where ORG=OFF)</p>  <p>■ 1 (Detect where ORG=ON)</p>  | | | | Settings | Detection Polarity | 0 | Detect where ORG=OFF | 1 | Detect where ORG=ON |
| Settings | Detection Polarity | | | | | | | | | |
| 0 | Detect where ORG=OFF | | | | | | | | | |
| 1 | Detect where ORG=ON | | | | | | | | | |
| No. 646.2 | Homing: Timeout enable switch | Settings 0, 1 | Default 0 | Characteristics  | | | | | | |
| Function Use | <p>Enable/Disable Homing Timeout. This item is a safety measure against collisions.</p> <table border="1" data-bbox="387 1227 1297 1335"> <thead> <tr> <th>Settings</th> <th>Timeout</th> </tr> </thead> <tbody> <tr> <td>0</td> <td>Disable</td> </tr> <tr> <td>1</td> <td>Enable</td> </tr> </tbody> </table> <p>When the time since homing started exceeds the setting of Timeout Time (659.0), Alarm No.10 (internal position command overflow fault / homing failure) is output leading to servo off.</p> | | | | Settings | Timeout | 0 | Disable | 1 | Enable |
| Settings | Timeout | | | | | | | | | |
| 0 | Disable | | | | | | | | | |
| 1 | Enable | | | | | | | | | |
| No. 646.3 | Homing: Point table - Motion of point No.0 | Settings 0, 1 | Default 0 | Characteristics  | | | | | | |
| Function Use | <p>Specify the motion upon PCSTART1 input by selecting Point No.0 with User I/O.</p> <table border="1" data-bbox="387 1664 1297 1771"> <thead> <tr> <th>Settings</th> <th>Motion of Point No.0</th> </tr> </thead> <tbody> <tr> <td>0</td> <td>Homing</td> </tr> <tr> <td>1</td> <td>Motion per Point Table</td> </tr> </tbody> </table> <p>Use this parameter for homing when the I/O assignments don't include homing input HOME.</p> | | | | Settings | Motion of Point No.0 | 0 | Homing | 1 | Motion per Point Table |
| Settings | Motion of Point No.0 | | | | | | | | | |
| 0 | Homing | | | | | | | | | |
| 1 | Motion per Point Table | | | | | | | | | |

| | | | | |
|--------------|--|----------------------|---------|-----------------|
| No. 647.0 | Homing: Torque command limit enable switch | Settings | Default | Characteristics |
| | | 0, 1 | 0 | |
| Function Use | Enable/Disable torque command limit during Homing. This item is a safety measure against collisions during Homing. | | | |
| | Settings | Torque Command Limit | | |
| | 0 | Disable | | |
| | 1 | Enable | | |
| | Use this parameter for homing when the I/O assignments don't include homing input HOME. | | | |
| Remark | For Homing by using stopper, this parameter setting does not matter. The torque limit used for press detection will be always the setting of Homing torque command limit value (656.0) regardless of this parameter setting. | | | |
| Related To | No. 656.0 | | | |

| | | | | |
|--------------|--|-------------------|---------|-----------------|
| No. 647.1 | Homing: Creep speed enable switch | Settings | Default | Characteristics |
| | | 0, 1 | 0 | |
| Function Use | Enable/Disable homing motion after home reference signal detection. | | | |
| | Set to 0 to only detect the home reference signal. Set to 1 if any motion is intended after the reference signal detection. | | | |
| | Settings | Motion afterwards | | |
| | 0 | None | | |
| | 1 | Move | | |
| | <p>■ 0 (None)</p> <p>After home reference signal is detected, the motor decelerates to stop and homing completes.</p> | | | |
| | <p>■ 1 (Move)</p> <p>After home reference signal is detected and then the motor decelerates to stop, motion to carefully approach to the home position follows according to the parameter setting.</p> | | | |

5. Parameters

| | | | | |
|-----------|------------------------|---------------------------------|-----------|-----------------|
| No. 648.0 | Homing: Rapid speed | Range | Default | Characteristics |
| | | 1 to Motor max rotational speed | 500 [rpm] | |

Specify the speed value for rough approach motion before the home reference signal is detected.

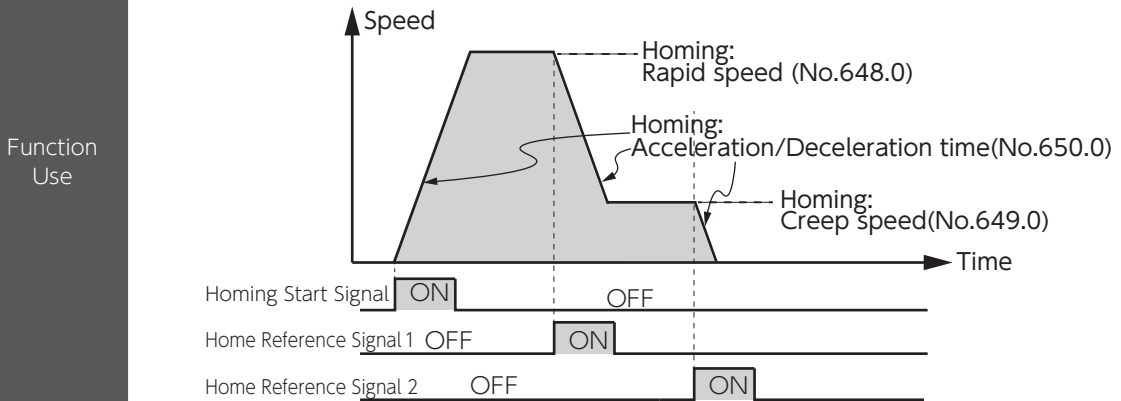

| | | | | |
|-----------|------------------------|---------------------------------|----------|-----------------|
| No. 649.0 | Homing: Creep speed | Range | Default | Characteristics |
| | | 1 to Motor max rotational speed | 10 [rpm] | |

Specify the speed for careful approach after the home signal is detected.
To improve accuracy to detect the home reference signal, select a lower speed.

| | |
|--------------|---|
| Prerequisite | Homing: Creep speed switch (647.1) : 1 (Move) |
| Related To | No. 645.0, No. 647.1, No. 648.0 |

| | | | | |
|-----------|---|------------|---------|-----------------|
| No. 650.0 | Homing: Acceleration/Deceleration time | Range | Default | Characteristics |
| | | 0 to 5,000 | 30 [ms] | |

Function Use: Set Acceleration/Deceleration Time for homing.
This item indicates time amount for a speed to change 1,000 rpm.
Applies to Rapid Speed (648.0) and Creep Speed (649.0)

Remark: If the load is more than 10 times of inertia ratio, set this parameter to a value larger than the default. Otherwise, vibration may occur.

| | | | | |
|-----------|--|--------------------|-------------------|-----------------|
| No. 651.0 | Homing: Amount of home position shift | Range | Default | Characteristics |
| | | 0 to 1,000,000,000 | 0 [command pulse] | |

Function Use: Use this parameter to set shift amount from home signal or encoder Z-phase to home.

| | |
|------------|-----------|
| Related To | No. 646.0 |
|------------|-----------|

| No. | Parameter Name | Range | Default | Characteristics |
|--------------|---|-------------------------------------|----------------------|-----------------|
| No. 653.0 | Homing: Home position data | -1,000,000,000 to +1,000,000,000 | 0 [command pulse] | |
| Function Use | This parameter value overwrites the home coordinate (ABS position feedback value) upon Homing complete. | | | |
| No. 655.0 | Homing: Time to detect press stopper | 5 to 1,000 | 100 [ms] | |
| Function Use | This parameter defines the torque command limiting time, which is a time amount for home to be detected after the stopper was pressed. | | | |
| Related To | No. 645.0, No. 647.0 | | | |
| No. 656.0 | Homing: Torque command limit value | 10 to 3,000 | 500 [0.1 %] | |
| Function Use | This parameter defines the ratio of torque command limit value (during homing) to the rated torque. The parameter is used as a safety measure against collisions during Homing. It is a torque command limit value in Homing by using stopper. | | | |
| Prerequisite | Homing: Home Reference Signal selection (645.0) = 1 (Stopper) or Torque command limit switch (647.0) = 1 (Enable) | | | |
| Related To | No. 645.0, No. 647.0 | | | |
| No. 657.0 | Homing: Z-phase disabled distance | 0 to 1,000,000,000 | 0 [command pulse] | |
| Function Use | Set the shift amount between a detection position of home signal and a starting position of z-phase detection. | | | |
| No. 659.0 | Homing: Timeout time | 0 to 60,000 | 60,000 [10 ms] | |
| Function Use | Set the timeout time for homing. This is a safety measure in case of fault during homing. | | | |
| Prerequisite | Timeout Switch (646.2) = 1 (Disable) | | | |
| Related To | No. 646.2 | | | |

5. Parameters

| | | | | |
|--|---|--|---|-----------------|
| No. 720.0 No. 740.0 to No. 1020.0 | Internal Position: Point table Command method (*) | Settings | Default | Characteristics |
| | | 0, 1 | 0 | |
| Function Use | Select the <u>command method</u> for point table. | | | |
| | Settings | Command Method | Position to be set | |
| | 0 | Absolute value | Target position | |
| | 1 | Relative value | Shift amount from the current position to the target position | |
| No. 720.1 No. 740.1 to No. 1020.1 | Internal Position: Point table Operation (*) | Settings | Default | Characteristics |
| | | 0, 1 | 0 | |
| Function Use | Select the <u>Running Motion</u> of Point Table | | | |
| | Settings | Running Motion | | |
| | 0 | Single | | |
| | 1 | Continuous | | |
| No. 720.3 No. 740.3 to No. 1020.3 | Internal Position: Point table Enable/Disable (*) | Settings | Default | Characteristics |
| | | 0, 1 | 0 | |
| Function Use | Enable/Disable Point Table. | | | |
| | Settings | Enable/Disable | | |
| | 0 | Disable The point number assigned “disable” is not executed and any subsequent point numbers assigned “enable” are executed. | | |
| | 1 | Enable The point number assigned “enable” is executed | | |
| No. 722.0 No. 742.0 to No. 1022.0 | Internal Position: Point table Position (*) | Range | Default | Characteristics |
| | | - 1,073,741,823 to +1,073,741,823 | 0 [command pulse] | |
| Function Use | Set the <u>target position</u> in Point Table. | | | |

*) See the Point Table Parameter List to look up a point number and its corresponding parameter numbers.

| | | | | |
|--|---|---|-----------------------|---|
| No. 724.0 No. 744.0 to No. 1024.0 | Internal Position: Point table Rotational speed (*) | Range | Default | Characteristics |
| | | 0 to Maximum Rotational Speed of Motor | 0 [rpm] |  |
| Function Use | Set the <u>motor rotational speed</u> for the Point Table. | | | |
| No. 726.0 No. 746.0 to No. 1026.0 | Internal Position: Point table Acceleration time (*) | Range | Default | Characteristics |
| | | 0 to 5,000 | 30 [ms] |  |
| Function Use | Set the <u>acceleration time</u> for the Point table. This item indicates the amount of time for a speed command to change from 0 [rpm] to 1,000 [rpm]. In the default setting, it takes 90 [ms] for the rotational speed to change from 0 [rpm] to 3,000 [rpm]. | | | |
| No. 727.0 No. 747.0 to No. 1027.0 | Internal Position: Point table Deceleration time (*) | Range | Default | Characteristics |
| | | 0 to 5,000 | 30 [ms] |  |
| Function Use | Set the <u>deceleration time</u> for the Point Table. This item indicates the amount of time for a speed command to change from 0 [rpm] to 1,000 [rpm]. In the default setting, it takes 90 [ms] for the rotational speed to change from 3,000 [rpm] to 0 [rpm]. | | | |
| No. 728.0 No. 748.0 to No. 1028.0 | Internal Position: Point table Dwell time (*) | Range | Default | Characteristics |
| | | 0 to 20,000 | 1 [ms] |  |
| Function Use | Set the <u>dwell time</u> for the Point Table. Dwell time is the wait time for the next Point-Table motion to be executed after a Point-Table motion is complete. | | | |
| No. 729.0 No. 749.0 to No. 1029.0 | Internal Position: Point table Positioning completion (*) | Range | Default | Characteristics |
| | | 0 to 32,767 | 20 [encoder pulse] |  |
| Function Use | Set the <u>range for positioning complete</u> by the Point table. | | | |

*) See the Point Table Parameter List to look up a point number and its corresponding parameter numbers.

5. Parameters

3. Point Table Parameter List

To configure point table data by using RS-485 Communications, refer to the cross table of point table items and their corresponding parameter numbers.

| Point No. | Position [command pulse] | Rotational speed [rpm] | Acceleration time [ms] | Deceleration time [ms] | Command method [-] | Dwell time [ms] | Operation [-] | Positioning completion [encoder pulse] | Enable /Disable [-] |
|-----------|--------------------------|------------------------|------------------------|------------------------|--------------------|-----------------|---------------|--|---------------------|
| 0 | No. 722.0 | No. 724.0 | No. 726.0 | No. 727.0 | No. 720.0 | No. 728.0 | No. 720.1 | No. 729.0 | No. 720.3 |
| 1 | No. 742.0 | No. 744.0 | No. 746.0 | No. 747.0 | No. 740.0 | No. 748.0 | No. 740.1 | No. 749.0 | No. 740.3 |
| 2 | No. 762.0 | No. 764.0 | No. 766.0 | No. 767.0 | No. 760.0 | No. 768.0 | No. 760.1 | No. 769.0 | No. 760.3 |
| 3 | No. 782.0 | No. 784.0 | No. 786.0 | No. 787.0 | No. 780.0 | No. 788.0 | No. 780.1 | No. 789.0 | No. 780.3 |
| 4 | No. 802.0 | No. 804.0 | No. 806.0 | No. 807.0 | No. 800.0 | No. 808.0 | No. 800.1 | No. 809.0 | No. 800.3 |
| 5 | No. 822.0 | No. 824.0 | No. 826.0 | No. 827.0 | No. 820.0 | No. 828.0 | No. 820.1 | No. 829.0 | No. 820.3 |
| 6 | No. 842.0 | No. 844.0 | No. 846.0 | No. 847.0 | No. 840.0 | No. 848.0 | No. 840.1 | No. 849.0 | No. 840.3 |
| 7 | No. 862.0 | No. 864.0 | No. 866.0 | No. 867.0 | No. 860.0 | No. 868.0 | No. 860.1 | No. 869.0 | No. 860.3 |
| 8 | No. 882.0 | No. 884.0 | No. 886.0 | No. 887.0 | No. 880.0 | No. 888.0 | No. 880.1 | No. 889.0 | No. 880.3 |
| 9 | No. 902.0 | No. 904.0 | No. 906.0 | No. 907.0 | No. 900.0 | No. 908.0 | No. 900.1 | No. 909.0 | No. 900.3 |
| 10 | No. 922.0 | No. 924.0 | No. 926.0 | No. 927.0 | No. 920.0 | No. 928.0 | No. 920.1 | No. 929.0 | No. 920.3 |
| 11 | No. 942.0 | No. 944.0 | No. 946.0 | No. 947.0 | No. 940.0 | No. 948.0 | No. 940.1 | No. 949.0 | No. 940.3 |
| 12 | No. 962.0 | No. 964.0 | No. 966.0 | No. 967.0 | No. 960.0 | No. 968.0 | No. 960.1 | No. 969.0 | No. 960.3 |
| 13 | No. 982.0 | No. 984.0 | No. 986.0 | No. 987.0 | No. 980.0 | No. 988.0 | No. 980.1 | No. 989.0 | No. 980.3 |
| 14 | No. 1002.0 | No. 1004.0 | No. 1006.0 | No. 1007.0 | No. 1000.0 | No. 1008.0 | No. 1000.1 | No. 1009.0 | No. 1000.3 |
| 15 | No. 1022.0 | No. 1024.0 | No. 1026.0 | No. 1027.0 | No. 1020.0 | No. 1028.0 | No. 1020.1 | No. 1029.0 | No. 1020.3 |

66





Operation

| | |
|--|-----------|
| 1. Configuring Operating Mode | 2 |
| 1. Related to Parameters | 3 |
| 2. Configuring Parameters | 4 |
| 2. Position Control Mode | 6 |
| 1. Pulse Train Command | 6 |
| 3. Velocity Control Mode | 10 |
| 1. Analog Velocity Command | 10 |
| 2. Internal Velocity Command | 13 |
| 4. Torque Control Mode | 15 |
| 1. Analog Torque Command | 15 |
| 5. Position Control Mode | 18 |
| 1. Internal Position Command (Point Table) | 18 |
| Operation by User I/O | 26 |
| 2. Homing | 35 |
| Types of Homing Motion | 39 |

1. Configuring Operating Mode

The drive is operated with any of the seven operating modes which are combinations of Control Mode and Command Mode. Configure parameters No.2.0 and No.3.0.

() The numeric values in the parentheses represent parameter settings.

| Control Mode (No.2.0) | Command Mode (No.3.0) | Command Input Signal Format |
|--------------------------------|--|---|
| Position Control (0 : Default) | Pulse Train Command (1 : Default) In this operating mode, position commands are issued from the host controller with pulse input.  Page 6- | <ul style="list-style-type: none"> • Differential • 24 V open collector • 5 V open collector |
| | Internal Speed Command (3) An operating mode used in the Positioner Drive function that enables you to execute positioning command preset in the drive with I/O operation from the host controller. Point table operation  Page 18- | <ul style="list-style-type: none"> • I/O operation |
| Velocity Control (1) | Analog Velocity Command (2) In this operating mode, speed commands are issued from the host controller with analog voltage input.  Page 10- | <ul style="list-style-type: none"> • Analog voltage |
| | Internal Speed Command (3) This type of operating mode moves the machine according to the speed preset in the drive with I/O input from the host controller.  Page 13- | <ul style="list-style-type: none"> • I/O operation |
| Torque Control (2) | Analog Torque Command (2) In this operating mode, torque commands are issued from the host controller with analog voltage input.  Page 15- | <ul style="list-style-type: none"> • Analog voltage |



CAUTION



Before performing wiring to each drive or motor, verify that all power sources are shut off.

All wiring work must be performed by certified electricians.

Before applying power to each drive or motor, be sure that wiring has been performed correctly.



1. Configuring Operating Mode

1. Related to Parameter

The following are the parameters that must be configured for all operating modes.

Common



| Name | No. | P. |
|---------------------------|-------------------------------|------------|
| Control mode | 2.0 | 5-34 |
| Command mode | 3.0 | 5-34 |
| Operation mode | 9.0 | 5-35 |
| Warning latch time | 12.0 | 5-36 |
| Alarm output timing | 13.0 | 5-36 |
| Torque command limit | Switch | 144.0 5-62 |
| | Value 1 | 147.0 5-63 |
| | Value 2 | 148.0 5-63 |
| Torque limit output | 144.1 | 5-63 |
| Servo OFF: Delay time | 237.0 | 5-75 |
| Brake release: Delay time | 238.0 | 5-75 |
| Absolute system | 257.0 | 5-76 |
| Encoder pulse output | Rotational direction | 272.1 5-77 |
| | Command pulse ratio Numerator | 276.0 5-78 |
| | Denominator | 278.0 5-78 |

Warning/Error Detection



| Name | No. | P. |
|--|--------------------------------------|-----------------------|
| Position error Error detection | Switch | 65.0 5-41 |
| | Value | 87.0 5-51 |
| | Delay time | 89.0 5-51 |
| Position error Warning detection | Value | 363.0 5-85 |
| | Delay time | 365.0 5-85 |
| | Switch | 65.1 5-41 |
| Speed error Error detection | Value | 90.0 5-51 |
| | Delay time | 91.0 5-51 |
| | Encoder pulse output Error detection | Frequency upper limit |
| | Delay time | 286.0 5-79 |
| Encoder Overheat detection | Switch | 259.0 5-76 |
| | Value | 267.0 5-77 |
| Encoder Battery Voltage drop detection | Switch | 259.1 5-76 |
| | Value | 268.0 5-77 |
| Voltage Dip Detection | Delay time | 305.0 5-83 |

RS-485 Communications



| Name | No. | P. |
|-----------------------|------|------|
| Switch | 8.0 | 5-35 |
| Address | 4.0 | 5-34 |
| Communication speed | 6.0 | 5-34 |
| Stop bit | 6.1 | 5-35 |
| Parity | 6.2 | 5-35 |
| Minimum response time | 11.0 | 5-35 |

Deceleration Stop



| Name | No. | P. |
|------------------------------------|----------------------------|------------|
| Upon Servo Off | Method | 224.0 5-68 |
| | DBRK output after stopping | 224.3 5-69 |
| When alarm is on | Method | 233.0 5-73 |
| | DBRK output after stopping | 233.1 5-74 |
| Release conditions | 224.1 | 5-68 |
| Operating time | 226.0 | 5-70 |
| Cancellation speed | 227.0 | 5-70 |
| Upon AC Supply loss | Switch | 224.2 5-69 |
| | Operating time | 228.0 5-70 |
| Torque command limit | 151.0 | 5-64 |
| Status during coast to stop | 232.1 | 5-71 |
| Short brake operation after a stop | 232.2 | 5-72 |
| Motor Brake engagement | Timing | 232.3 5-72 |
| | Delay time | 234.0 5-74 |
| | Rotational speed | 235.0 5-74 |

Drive Limit Switch Input



| Name | No. | P. |
|----------------------------------|------|------|
| Setup | 67.0 | 5-43 |
| Deceleration method | 67.1 | 5-43 |
| Idling status | 67.2 | 5-43 |
| Retaining position error counter | 67.3 | 5-43 |

For each operating mode, its supporting parameters must be configured. For details, refer to the subsequent sections describing each operation mode.

Parameter Tuning Methods



Use the Setup Panel at the front of the drive for tuning.

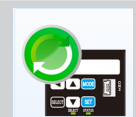

Use the setup software Digitax SF Connect for tuning. Install it on the user-supplied computer.

1. Configuring Operating Mode

2. Configuring Parameters

Using the Setup Panel

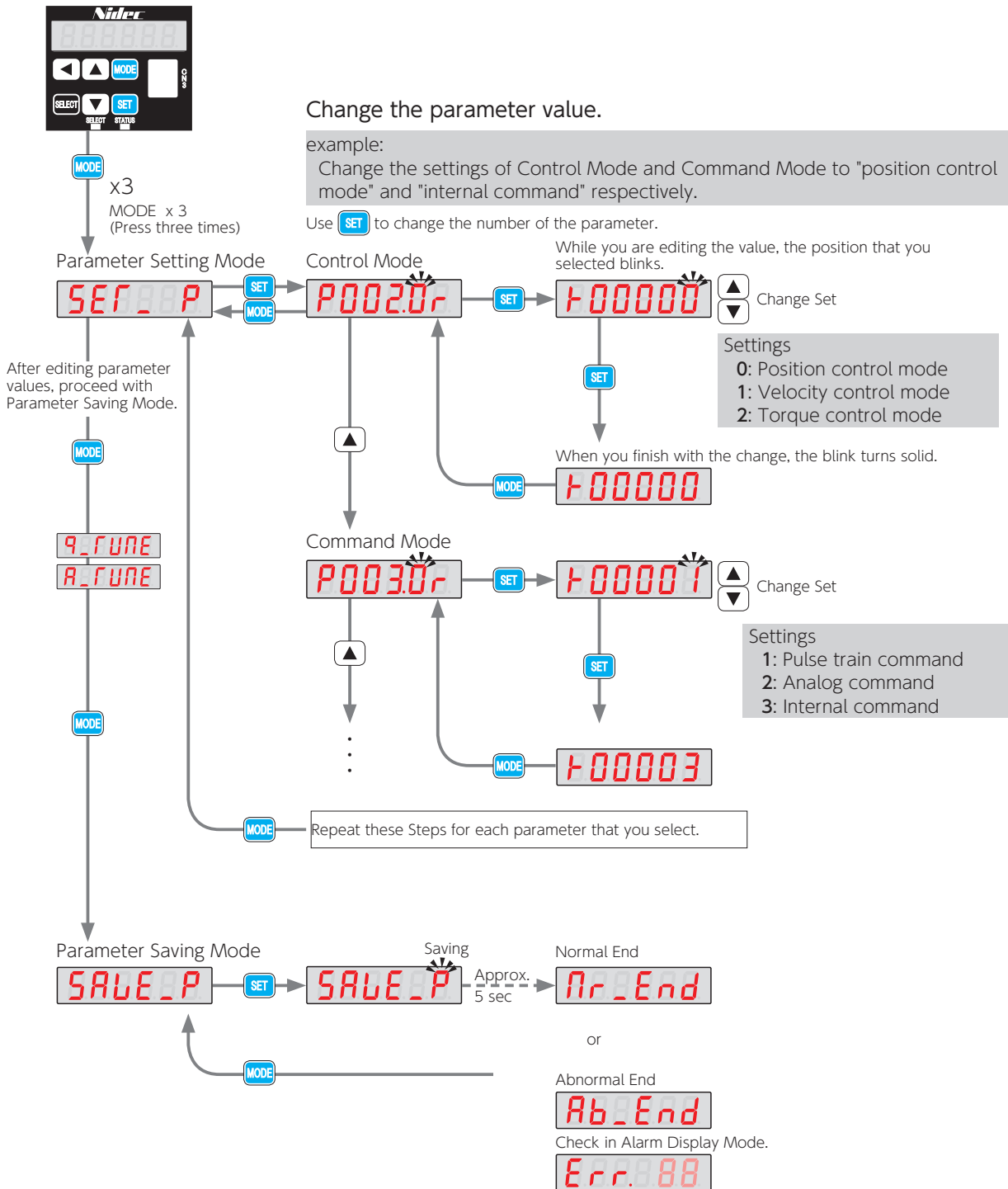

Save the parameter settings in Parameter Saving mode to the drive. If you shut down the drive without saving them, the changes will not take effect.

1. Configuring Operating Mode

Using Digitax SF Connect

Step 1 Start

Double-click on



1. Select the Communication Setup tab (initial display)

2. List of the compatible drives
 → Select the drive that you are connecting
 → If you don't see your drive, Click Get to display new versions and select your drive version.

3. Click

Connection Status: Online Offline

Step 2 Set parameters



1. Select the Parameter Tab

| No. | Name | Default | Unit | Value | Change settings |
|------|--|-----------|------|-------|-----------------|
| 2.0 | Command group | | | | |
| 3.0 | Command mode | Position | Hz | | * |
| 4.0 | RS-485 Comm. | | | | |
| 5.0 | RS-485 Comm. | | | | |
| 5.0 | Operation mode | | | | |
| 11.0 | RS-485 Comm. | | | | |
| 32.0 | Pulse train comm. | | | | |
| 32.1 | Pulse train comm. | | | | |
| 32.2 | Pulse train command - Auto Interpolations for geared ratio | Necessary | Hz | 1 | |
| 32.3 | Pulse train command - Input logic | Necessary | Hz | 0 | |
| 33.0 | Pulse train command - Input filter selection | Necessary | Hz | 4 | |
| 34.0 | Pulse train command - Filtered ratio incrementation | Necessary | Hz | 32768 | |
| 35.0 | Pulse train command - Filtered ratio | | | | |
| 40.0 | Analog speed - Input filter (Hz) | | | | |

2. In the row of the parameter to edit, click on the cell in the Value column to edit.
 → When you make a change in a value cell, *(asterisk) will appear in the Change settings column.

3. Click Set to write to RAM.
 → The *(asterisk) in the Change settings column will disappear.

4. Click Write to save to the drive EEPROM.

Step 3 Finish

Method 1
 Click Disconnect under the quick tool bar.

Method 2
 1. Select the Communication Settings tab.
 2. Click Disconnect

Method 1, 2
 Cycle control-power to finish so that the change that you just made will take effect.

6. Operation

2. Position Control Mode

1. Pulse Train Command

Required Parameters

Set the operating mode with the following parameters.

| Parameter No. | Name | Setting |
|---------------|----------------------------------|--|
| 2.0 | Control Mode | 0 : Position Control Mode (Default) |
| 3.0 | Command Mode | 1 : Pulse Train Command Mode (Default) |
| 32.0 | Input pulse form (*) | Select one. 0 : Pulse and direction (PLS & DIR) (Default) 1 : Quadrature phase difference pulse (A-Phase & B-Phase) 2 : Input in positive or negative pulse (CCW & CW) |
| 33.0 | Input Filter | Helps to reduce possible malfunctions caused by noise. You must configure this parameter in the case of command input by open collector. Default: 4 (150 ns) |
| 34.0 | Paired Pulse Ratio (Numerator) | 32,768 (Default : 1,000 [pulse/rev]) |
| 36.0 | Paired Pulse Ratio (Denominator) | Set to [pulse count of the host controller output] divided by 4 Default : 1,000 [pulse/rev] |

 **5** Settings, **9** Appendices

*) Pulse command input form (see the table above) and Minimum Time Interval (see the table below).

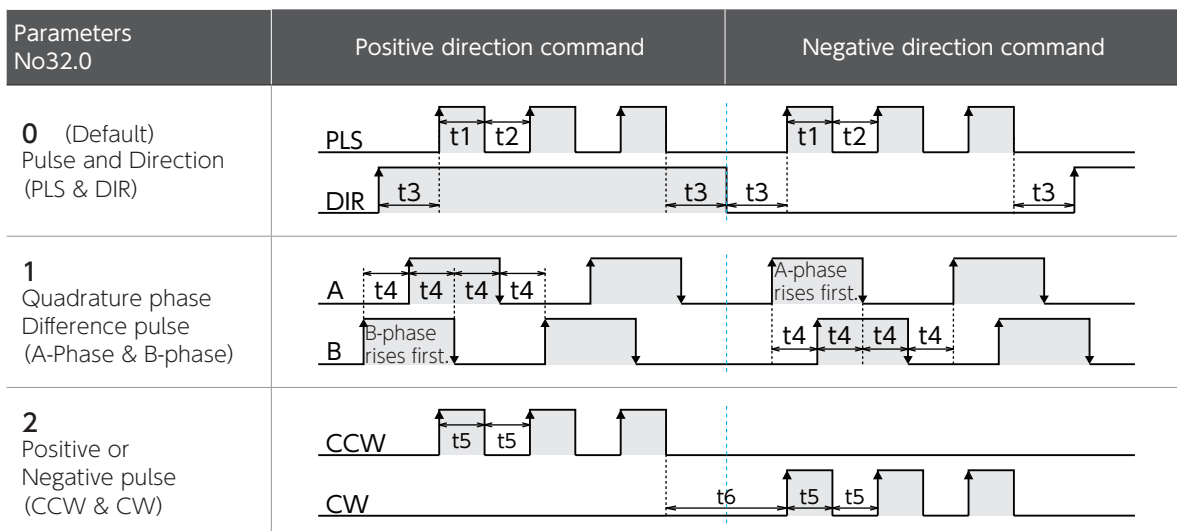

| Input pulse signal | Maximum command pulse frequency | Minimum time interval [μs] | | | | | |
|--------------------|---------------------------------|----------------------------|-------|-----|------|-------|-------|
| | | t1 | t2 | t3 | t4 | t5 | t6 |
| Differential | 4 Mpps | 0.125 | 0.125 | 2.5 | 0.25 | 0.125 | 0.125 |
| Open collector | 200 kpps | 2.5 | 2.5 | 2.5 | 2.5 | 2.5 | 2.5 |



The amount of time needed for rising or falling edge of the command pulse input signal must be $0.1 \mu\text{s}$ or below. The number of pulses is counted at the rising edge (from low level to high level). The input logic can be changed with Parameter No.32.3.

Optional Parameters

The following parameters are optional. Configure them, as necessary.

| Name | Description | Parameter No. |
|----------------------|------------------------------------|--|
| Pulse Train Command | Direction of Rotation | See below |
| | Input Logic | Select the pulse train input logic Default : 1 (Negative logic) |
| Positioning Complete | Determination Method | 64.0 |
| | Detection Criteria (Range) | Specify the conditions for Positioning Complete |
| | Detection Criteria (Speed) | 69.0 |
| | Detection Criteria (Command input) |  Settings |
| | Detection Time Delay | 71.0 |

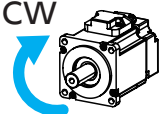
Configuration of Parameter No.32.1 and Rotational Direction of the Motor

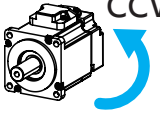
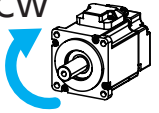
| Parameter No.32.1 | Command pulse from the controller | |
|-------------------|---|---|
| | Positive direction command | Negative direction command |
| 0 |  |  |
| 1 (Default) |  |  |

2. Position Control Mode

Input Pulse Form and Parameter Setting

The command pulse is counted at the rising edge in the positive logic and the falling edge in the negative logic.

Pulse and Direction (PLS & DIR) (No.32.0 = 0)

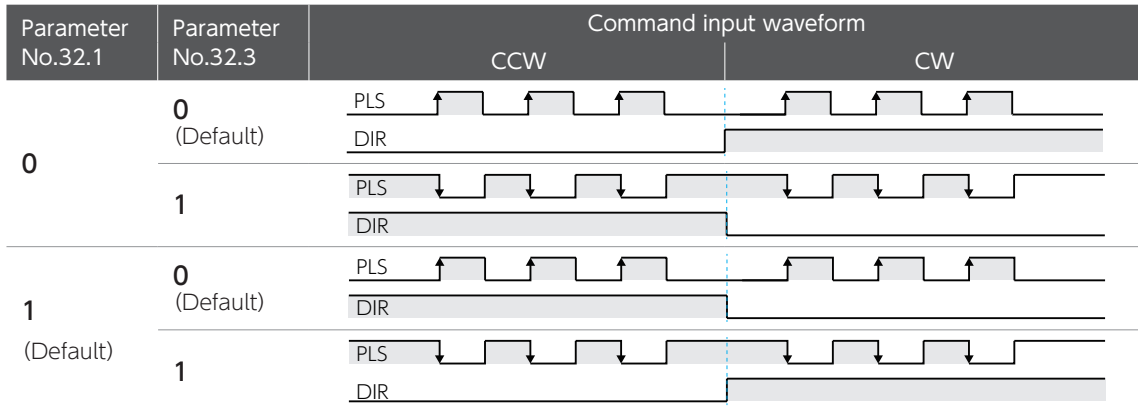

- Changing the setting of Parameter No.32.3 will reverse the direction signal (DIR) logic.
- Change the direction signal (DIR) when PLS is LOW where No.32.3=0 and PLS is HIGH where No.32.3=1.

Quadrature phase Difference pulse (A-Phase & B-phase) (No.32.0 = 1)

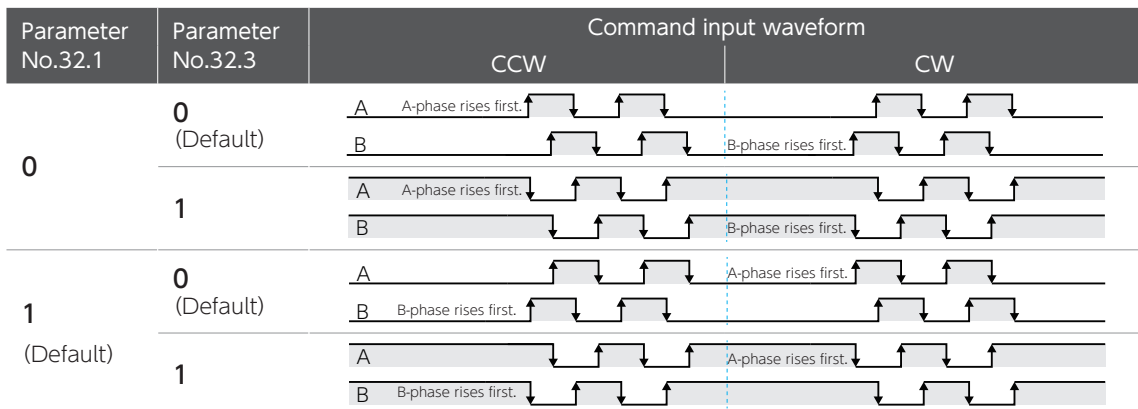



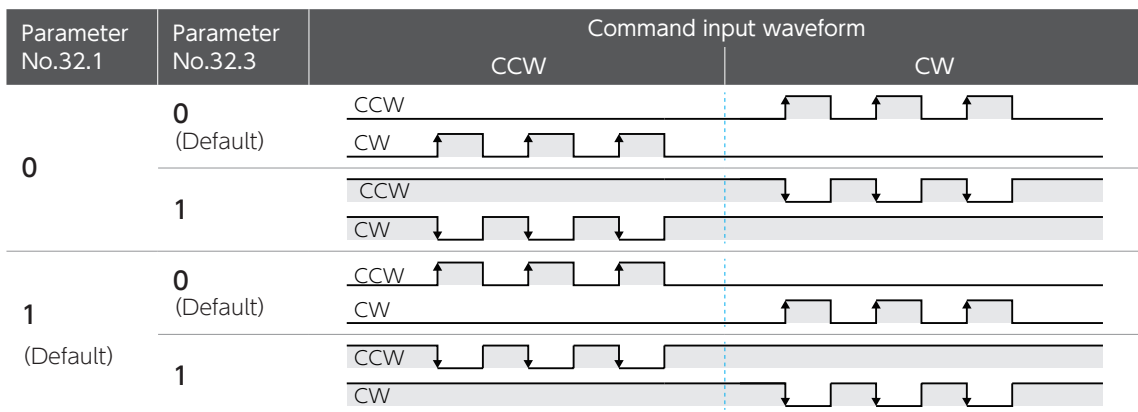

- No direction signal logic change by Parameter No.32.3.

Positive or Negative pulse (CCW & CW) (No.32.0 = 2)



Precautions for Testing

| | | |
|---|--|---|
|  | Before applying power to each drive or motor, be sure that all wiring has been performed properly. |  |
| | Set the parameters correctly before testing. |  |
| | Check motor motion first with no machine connected. |  |
| | For a brake-equipped motor, be sure to disengage the brake before driving the motor. |  |

Testing Procedure

| Step | Operation |
|---------------|---|
| Step 1 | Verify that wiring has been performed correctly. |
| Step 2 | Turn on the control power to the drive. |
| Step 3 | Turn on the AC Supply to the drive. |
| Step 4 | Connect the SVON pin on CN1 connector to COM- to turn the servo on. |
| Step 5 | <p>Input the position command pulse from the host controller in low frequency, and run the motor at low speed (around 100 rpm).</p> <p>Be sure that the actual rotational direction of the motor agrees with the direction setting. Verify that stopping the command pulse does stop the motor.</p> |
| Step 6 | <p>After ensuring correct direction of actual motion, increase the frequency of position command pulse gradually and check motor motion.</p> <p>If vibration occurs, increase the inertia ratio.</p> |

 **8** Troubleshooting

3. Velocity Control Mode

1. Analog Velocity Command

Required Parameters

Start testing only after configuring the parameters.

Set the operating mode.

| Parameter No. | Name | Setting |
|---------------|--------------|---|
| 2.0 | Control Mode | 1: Velocity Control mode (Default: 0 Position control mode) |
| 3.0 | Command Mode | 2: Analog command (Default: 1 Pulse train command) |

Optional Parameters

The following parameters are optional. Configure them as necessary.

| Name | | Explanation | Parameter No. |
|-----------------------|---------------------|---|---------------|
| Offset | Adjustment | Adjust the offset, such that the motor speed becomes 0 rpm when the command input is 0 V. | 62.2 |
| | Value | | 60.0 |
| Direction of Rotation | | Select CCW or CW. (*3) | 62.0 |
| Input Filter | Enable Switch | | 62.1 |
| | Numerator | Apply this parameter to filter the noise component of input command voltage. | 48.0 |
| | Denominator | | 49.0 |
| Input gain | Numerator | Set the rotational speed at max command input voltage (± 10 V). (*1) | 50.0 |
| | Denominator | | 51.0 |
| Speed limit | CCW | Numerator | 52.0 |
| | | Denominator | 53.0 |
| | CW | Numerator | 54.0 |
| | | Denominator | 55.0 |
| Smoothing Filter | Enable Switch | Apply this filter to reduce the variance of the motor speed. | 77.0 |
| | Moving Average Time | | 78.0 |



3. Velocity Control Mode

*1) Example of Input Gain Configuration

Input Gain is configured with the following two parameters:

Numerator (No.50.0): desired max rotational speed

Denominator (No.51.0): max rotational speed of the motor

Example of setting the max command input voltage (± 10 V) to 3,000 [rpm] for the motor with 5,000 [rpm] max rotational speed.

| Parameter No. | Setting [rpm] |
|---------------|---------------|
| 50.0 | 3,000 |
| 51.0 | 5,000 |

*2) Example of Speed Limit Configuration

Speed limit is configured with the following two parameters:



Numerator (CCW: No.52.0, CW: No.54.0): desired max rotational speed limit

Denominator (CCW: No.53.0, CW: No.55.0): max rotational speed of the motor

Example of setting the max rotational speed limit to 3,000 [rpm] for the motor of 5,000 [rpm] max rotational speed.



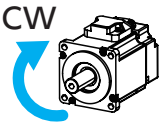

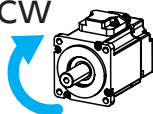
| Direction of Rotation | Parameter No. | Setting [rpm] |
|-----------------------|---------------|---------------|
| CCW | 52.0 | 3,000 |
| | 53.0 | 5,000 |
| CW | 54.0 | 3,000 |
| | 55.0 | 5,000 |

*3) Configuration of Parameter No.62.0 and Rotational Direction of the Motor

| Parameter No.62.0 | Input Analog Command Voltage | |
|-------------------|---|---|
| | Positive Voltage | Negative Voltage |
| 0 |  |  |
| 1 (Default) |  |  |

3. Velocity Control Mode

Precautions for Testing

| | | |
|---|--|---|
|  | Before applying power to each drive or motor, be sure that all wiring has been performed properly. |  |
| | Set the parameters correctly before testing. |  |
| | Check motor motion first with no machine connected. |  |
| | For a brake-equipped motor, be sure to disengage the brake before operating the motor. |  |

Testing Procedure

| Step | Operation |
|---------------|--|
| Step 1 | Verify that wiring has been performed correctly. |
| Step 2 | Turn on the control power to the drive. |
| Step 3 | Turn on the AC Supply to the drive. |
| Step 4 | Connect the SVON pin of CN1 connector to COM- to turn the servo on. |
| Step 5 | Input the analog velocity command voltage with a low voltage to run the motor at a low speed. Be sure that the actual rotational direction of the motor agrees with the direction setting. Verify that the motor speed changes depending on the input voltage. |
| Step 6 | After ensuring correct direction of actual motion, increase the command voltage gradually and check motor motion. Verify that the rotational speed has reached the specified speed. If vibration occurs, increase the inertia ratio. |

3. Velocity Control Mode

2. Internal Velocity Command

Required Parameters

Start testing only after configuring the parameters.

Set the operating mode.

| Parameter No. | Name | Setting |
|---------------|--------------------------------------|---|
| 2.0 | Control Mode | 1: Velocity Control Mode (Default: 0 Position control mode) |
| 3.0 | Command Mode | 3: Internal Command (Default: 1 Pulse train command) |
| 388.0 | Internal Velocity: Command Method | 1: Preset Speed Command (8 settings) (Default: 0 Zero command) |

Optional Parameters

The following parameters are optional. Configure them as necessary.





| Name | Explanation | Parameter No. |
|-------------------|---|---|
| Acceleration Time | amount of time for speed command to increase the speed from 0 [rpm] to 1,000 [rpm] Default: 1,000 [ms] | 390.0 |
| Deceleration Time | amount of time for the speed command to decrease the speed from 1,000 [rpm] to 0 [rpm] Default: 1,000 [ms] | 391.0 |
| Speed 1 to 8 | Target speed Default: See below | 392.0 to 399.0 |
| Smoothing Filter | Enable Switch | Apply this filter to reduce the speed variation of the motor. Default : 77.0 = 0 (Disable) |
| | Moving Average Time | 78.0 = 100 [ms] |

| Parameter No. | Target Speed | Setting (Default) | | [rpm] |
|---------------|--------------|--------------------------------|-------|-------|
| | | 50 W to 750 W | 1 kW | |
| 392.0 | 1 | | 500 | |
| 393.0 | 2 | | 1,000 | |
| 394.0 | 3 | | 1,500 | |
| 395.0 | 4 | | 2,000 | |
| 396.0 | 5 | | 2,500 | |
| 397.0 | 6 | | 3,000 | |
| 398.0 | 7 | 4,000 | | 3,000 |
| 399.0 | 8 | Motor Max Rotational Speed (*) | | |

*)  5 Setting

3. Velocity Control Mode

Precautions for Testing

| | | |
|---|--|---|
|  | Before applying power to each drive or motor, be sure that all wiring has been performed properly. |  |
| | Set the parameters correctly before testing. |  |
| | Check motor motion first with no machine connected. |  |
| | For a brake-equipped motor, be sure to disengage the brake before operating the motor. |  |

Testing Procedure

| Step | Operation |
|---------------|--|
| Step 1 | Verify that wiring has been performed correctly. |
| Step 2 | Turn on the 24 VDC control power to the drive. |
| Step 3 | Turn on the AC Supply to the drive. |
| Step 4 | <p>Connect the SVON pin of CN1 connector to COM- to turn the servo on.</p> <p>Select one of target speeds with open/closed combinations of VCSEL1, VCSEL2, and VCSEL3, and turn either VCRUN1 or VCRUN2 ON.</p> <p>The motor will rotate accordingly.</p> |
| Step 5 | <p>Refer to the following “Motor Rotational Direction” and “Speed Settings” to operate the motor.</p> <p>Be sure that the actual rotational direction of the motor agrees with your direction setting.</p> <p>Verify that has the rotational speed has reached your speed setting.</p> <p>If vibration occurs, increase the inertia ratio.</p> |

RUN Operation and Rotational Direction of the Motor

| Motor Rotational Direction | Operation VCRUN1 | VCRUN2 |
|----------------------------|------------------|--------|
| CCW | Closed | Open |
| CW | Open | Closed |
| Stop | Open | Open |
| Stop | Closed | Closed |

Closed : Contact with COM-
Open : No contact with COM-

Speed Settings

| Target Speed | VCSEL1 | | VCSEL2 | | VCSEL3 | |
|--------------|--------|----------|--------|----------|--------|-----------|
| | CN1 | Pin No.8 | CN1 | Pin No.9 | CN1 | Pin No.10 |
| 1 | Open | Open | Open | Open | Open | Open |
| 2 | Closed | Open | Open | Open | Open | Open |
| 3 | Open | Closed | Closed | Open | Open | Open |
| 4 | Closed | Closed | Closed | Closed | Open | Open |
| 5 | Open | Open | Open | Open | Closed | Closed |
| 6 | Closed | Open | Open | Open | Closed | Closed |
| 7 | Open | Closed | Closed | Closed | Closed | Closed |
| 8 | Closed | Closed | Closed | Closed | Closed | Closed |

4. Torque Control Mode

1. Analog Torque Command

Required Parameters

Set the parameters before testing.

Set the operating mode.

| Parameter No. | Name | Setting |
|---------------|--------------|---|
| 2.0 | Control Mode | 2: Torque Control Mode (Default: 0 Position control mode) |
| 3.0 | Command Mode | 2: Analog Command (Default: 1 Pulse train command) |

Optional Parameters

The following parameters are optional. Configure them as necessary.

| Name | | Explanation | Parameter No. | |
|-----------------------|---------------|--|---------------|-------|
| Offset | Adjustment | Adjust the offset, such that the motor torque command becomes 0 [0.1 %] when the command input is 0 V. | 302.2 | |
| | Value | | 300.0 | |
| Direction of Rotation | | Select the CCW or CW. (*3) | 302.0 | |
| Input Filter | Enable Switch | Apply this parameter to filter the noise component of input command voltage. | 302.1 | |
| | Numerator | | 288.0 | |
| | Denominator | | 289.0 | |
| Input Gain | Numerator | Set the torque at the max command input voltage (± 10 V). (*1) | 290.0 | |
| | Denominator | | 291.0 | |
| Torque Limit | CCW | Set the torque limit during CCW rotation. (*2) | Numerator | 292.0 |
| | | | Denominator | 293.0 |
| | CW | Set the torque limit during CW rotation. (*2) | Numerator | 294.0 |
| | | | Denominator | 295.0 |
| Speed Limit | | Set the speed limit. | 152.0 | |

 5 Settings

4. Torque Control Mode

*1) Example of Input Gain Configuration

Input Gain is configured with the following two parameters:

Numerator (No.290.0): desired max torque

Denominator (No.291.0): max torque of the motor

Example: the parameter settings (for a motor with the 300 % max torque) to 100 % at the max command

| Parameter No. | Setting [Unit : 0.1 %] |
|---------------|---------------------------|
| 290.0 | 1,000 |
| 291.0 | 3,000 |

*2) Example of Torque Limit Configuration

Torque Limit is configured with the following two parameters:



Numerator (CCW: No.292.0, CW: No.294.0): desired torque limit

Denominator (CCW: No.293.0, CW: No.295.0): max torque limit of the motor



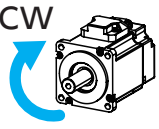
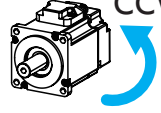

Example: Setting the max torque limit to 100 % for the motor of the 300 % max torque

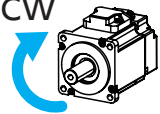
| Direction of Rotation | Parameter No. | Setting [Unit : 0.1 %] |
|-----------------------|---------------|---------------------------|
| CCW | 292.0 | 1,000 |
| | 293.0 | 3,000 |
| CW | 294.0 | 1,000 |
| | 295.0 | 3,000 |

*3) Configuration of Parameter No.302.0 and Rotational Direction of the Motor

| Parameter No.302.0 | Input Analog Command Voltage | |
|--------------------|---|---|
| | Positive Voltage | Negative Voltage |
| 0 |  |  |
| 1 (Default) |  |  |

Precautions for Testing

| | | |
|---|--|---|
|  | Before applying power to each drive or motor, be sure that all wiring has been performed properly. |  |
| | Set the parameters correctly before testing. |  |
| | Check motor motion first with no machine connected. |  |
| | For a brake-equipped motor, be sure to disengage the brake before operating the motor. |  |

Testing Procedure

| Step | Operation |
|---------------|---|
| Step 1 | Verify that wiring has been performed correctly. |
| Step 2 | Turn on the control power to the drive. |
| Step 3 | Turn on the AC Supply to the drive. |
| Step 4 | Set [Analog torque: Speed limit (No.152)] to a sufficiently small value (around 500 [rpm]). |
| Step 5 | Connect the SVON pin of CN1 connector to COM- to turn the servo on. |
| Step 6 | Set [Analog torque: Speed limit (No.152)] to the value to be used in actual operation. |
| Step 7 | Input the analog torque command voltage with a low voltage to run the motor with a low torque. Be sure that the actual rotational direction of the motor agrees with the direction setting. Verify that the motor speed changes according to the input voltage. |
| Step 8 | After ensuring safety for actual motion, increase the command voltage gradually and check motor motion. |

5. Position Control Mode

1. Internal Position Command (Point Table)

Internal Position Command is used for the Positioner Drive function.

This function enables you to preset data for the Point Table in the drive and set up Point Numbers that you want to execute with I/O input from the host controller. When the start signal is input, positioning starts based on the user-selected Point No.

Positioner Drive

The Positioner Drive is a function for positioning operation based on I/O commands issued by the host controller such as PLC.

Homing can be performed in the user-equipment in which Digitax SF is installed.

The Point Table stores motion patterns and Digitax SF Connect is used for the Point Table setup. Testing the Positioner operation can be done using Digitax SF Connect

1. Configuring Parameters

 Page 19 Required Parameters

2. Creating Point Table and Testing

To enable Positioner Drive, set the point table parameters. Use Digitax SF Connect for the point table configuration.

 Page 20 Creating Point Table

Test the point table operation with Digitax SF Connect before operation with user I/O.

 Digitax SF Connect Users Guide

3. Operation by User I/O

You can select a motion pattern from five typical motion patterns.

 Page 26 Operation by User I/O

Precautions

1. In case of the following, the motion started by the point table will be stopped and the remaining commands will be canceled.
 - The servo turns off.
 - Clear Position error Counter is executed.
(When Clear Position error Counter is executed, the motor will make a quick stop.)
2. The motor moves according to the point table settings at the start time of Positioner operation. The current motion is not affected by any changes made to the point table in the middle of the motion.

Required Parameters

1. Configuring Parameters

Set the operating mode.

| Parameter No. | Name | Setting |
|---------------|---|---|
| 2.0 | Control Mode | 0: Position Control Mode |
| 3.0 | Command Mode | 1: Pulse train command 3: Internal Command |
| 9.0 | Operation Mode (*1) | 0: Using I/O input 1: Using Digitax SF Connect |
| 642.0 | Internal Position Operation Mode | 0: Point Table |
| 643.0 | Internal Position Overflow Detection | 1: Enable overflow detection (Default) |
| 644.0 | Internal Position Point No. Output Method | Set up this parameter when the I/O setting type is "Option 1". (*2) Otherwise, no need to be configured. |

- *1) The setting is 0 (I/O Operation) upon drive power on. You can set this item only with Digitax SF Connect not on the Setup Panel.
- *2) You can specify output timing of subsequent point numbers upon motion complete. The point number output format is illustrated at the bottom of the timing diagram below.

Example: Point Table Setting and Timing Diagram of the Point No. Output

| Point No. | Running Operation | Dwell Time |
|-----------|-------------------|-------------|
| 1 | continuous | 0 |
| 2 | continuous | 0 |
| 3 | single | (any value) |

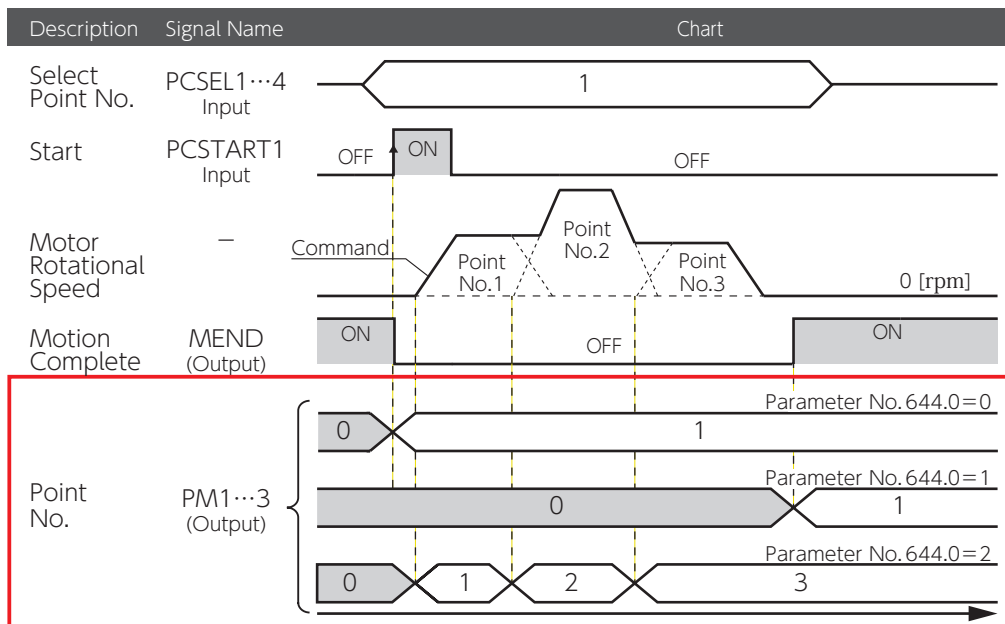

5. Position Control Mode

Creating Point Table

Set the following items for the point table. Use Digitax SF Connect for editing point table. Set and Write the point table you created to the drive.

 Digitax SF Connect Users Manual

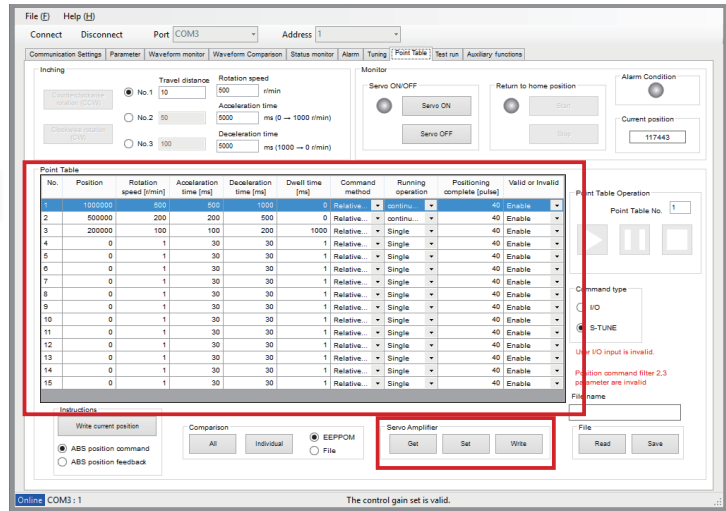

| Item | No. | Range | Units |
|------|-----|---------|-------|
| | | (fixed) | [-] |

Description
 This item indicates the point number specified by I/O command. By default, Homing is assigned to Point No.0. The point table has 15 points. If you are not using the Homing function, Point No.0 becomes available and the table can have 16 points. When the type of I/O assignments is "Option 1", the motion (No.646.3) corresponding to Point No.0 is set to 1 (point table motion).

| Item | Position | Range | Units |
|------|----------|---------------------------------------|-------------------|
| | | - 1,073,741,823 to + 1,073,741,823 | [encoder pulse] |

Description
If Relative is selected as the Command method,
 The position data will determine the shift amount.
 A positive value indicates CCW rotation, a negative value indicates CW rotation
If Absolute is selected as Command method,
 The position data will determine the target position.
 This value corresponds to ABS Position Command value (Status No.74).
Related to:
 Internal position: Overflow detection (No.643.0)

| | | | |
|-------------|--|--|---------|
| Item | Rotation speed | Range | Units |
| | | 1 to max rotational speed | [rpm] |
| Description | Set the motor rotational speed during the Positioner operation. Set this item to a speed no higher than the max rotational speed of the motor. | | |
| Item | Acceleration time | Range | Units |
| | | 0 to 5,000 | [ms] |
| Description | Set this item to amount of time for the rotational speed to increase from 0 rpm to 1,000 rpm. | | |
| Item | Deceleration time | Range | Units |
| | | 0 to 5,000 | [ms] |
| Description | Set this item to amount of time for the rotational speed to decrease from 1,000 rpm to 0 rpm. | | |
| Item | Dwell time | Range | Units |
| | | 0 to 20,000 | [ms] |
| Description | <p>Set the wait time after Positioning Complete per the selected Point No.</p> <p>Motion after the dwell time elapses</p> <p>“Single” Motion: MEND will be ON.</p> <p>“Continuous” Motion: the motion per the next point number will start.</p> <p>If Running Motion is “Continuous” and the dwell time is set to 0, the motion will be according to the speed specified by point numbers, one after another continuously.</p> <p>If the dwell time is set to 0, the acceleration/deceleration setting in the first point number selected upon CW start PCSTART1 ON will be applied, and the acceleration/deceleration time settings of subsequent point numbers will be discarded.</p> | | |
| | |  Page 23 Positioning Complete | |
| Item | Command method | Range | Units |
| | | Relative, Absolute | [-] |
| Description | Absolute: the setting of Position will be the shift amount from the current position to the target position. Relative: the setting of Position will be the target position. | | |

5. Position Control Mode

| Item | Running operation | Setting | Units |
|------|-------------------|--------------------|-------|
| | | Continuous, Single | [-] |

Configuring Running Motion in the Point Table enables you to execute a series of continuous positioning motion and continuous speed changes.

Page 24 Valid or Invalid

Single: After the motion specified by this point number is complete, the subsequent point numbers will not be executed.

Example: Point No.1 and 2 are set to "Single" .

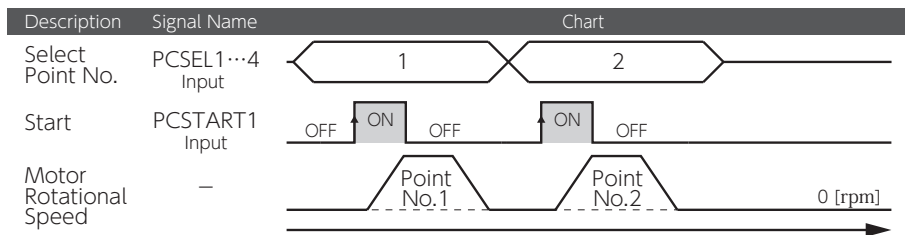

Continuous: the subsequent point number(s) will be executed.

Example If Running Motion = continuous and Dwell Time = 1 or above (for example, 3ms), then positioning will be executed according to each point. The drive will wait for the target position to be reached, then apply the dwell time, and will then start the next motion

Description

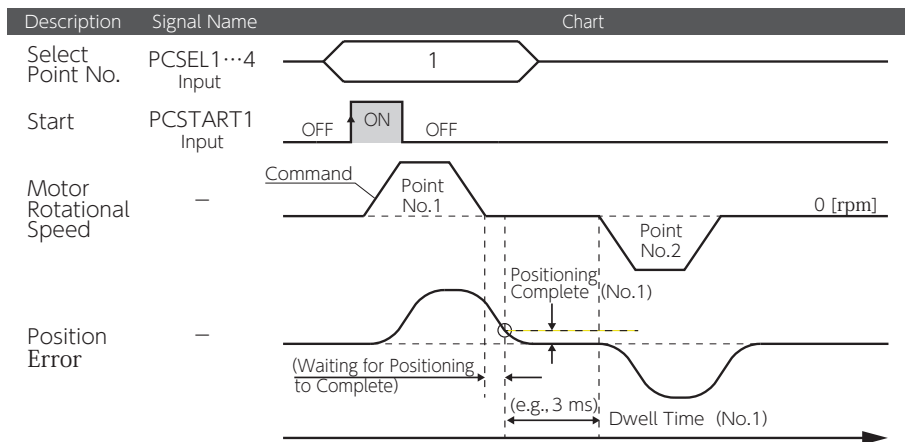

Example If Running Motion = continuous and Dwell Time = 0, the motor will not stop and the rotational speed will change continuously.

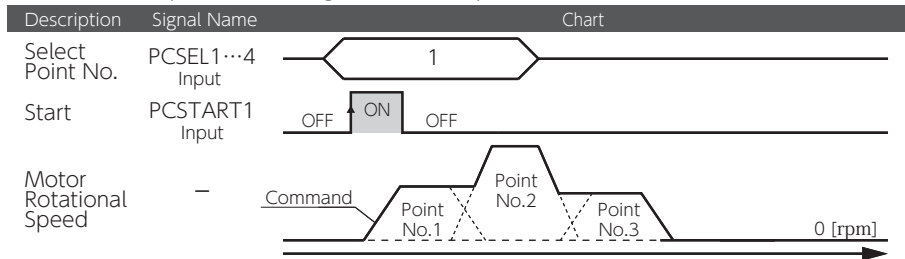

| Item | Positioning complete | Range 0 to 32,767 | Units [pulse] | | | | | | | | | | | | | | | | | | | | | | | | |
|---|---|----------------------|--------------------|-------------|-------------|-------|--|------------------|------------------|--|--|-------|----------------|--|--|------------------------|---|--|--|----------------|---|--|--|-----------------|---------------|--|--|
| Description | <p>Set a position error threshold to determine whether or not positioning is complete.</p> | | | | | | | | | | | | | | | | | | | | | | | | | | |
| | <p>After the motion specified by the point number has been complete, when the position error falls in the range set by this parameter and then the Dwell time elapses, the MEND (motion end) signal turns ON.</p> | | | | | | | | | | | | | | | | | | | | | | | | | | |
| <p>Timing Diagram (Positioning complete and Dwell time)</p> | | | | | | | | | | | | | | | | | | | | | | | | | | | |
| <table border="1"> <thead> <tr> <th data-bbox="379 672 598 705">Description</th> <th data-bbox="598 672 730 705">Signal Name</th> <th colspan="2" data-bbox="730 672 1444 705">Chart</th> </tr> </thead> <tbody> <tr> <td data-bbox="379 705 598 772">Select Point No.</td> <td data-bbox="598 705 730 772">PCSEL1...4 Input</td> <td colspan="2" data-bbox="730 705 1444 772"> </td> </tr> <tr> <td data-bbox="379 772 598 840">Start</td> <td data-bbox="598 772 730 840">PCSTART1 Input</td> <td colspan="2" data-bbox="730 772 1444 840"> </td> </tr> <tr> <td data-bbox="379 840 598 1019">Motor Rotational Speed</td> <td data-bbox="598 840 730 1019">-</td> <td colspan="2" data-bbox="730 840 1444 1019"> </td> </tr> <tr> <td data-bbox="379 1019 598 1176">Position Error</td> <td data-bbox="598 1019 730 1176">-</td> <td colspan="2" data-bbox="730 1019 1444 1176"> </td> </tr> <tr> <td data-bbox="379 1176 598 1288">Motion Complete</td> <td data-bbox="598 1176 730 1288">MEND (Output)</td> <td colspan="2" data-bbox="730 1176 1444 1288"> </td> </tr> </tbody> </table> | | | | Description | Signal Name | Chart | | Select Point No. | PCSEL1...4 Input | | | Start | PCSTART1 Input | | | Motor Rotational Speed | - | | | Position Error | - | | | Motion Complete | MEND (Output) | | |
| Description | Signal Name | Chart | | | | | | | | | | | | | | | | | | | | | | | | | |
| Select Point No. | PCSEL1...4 Input | | | | | | | | | | | | | | | | | | | | | | | | | | |
| Start | PCSTART1 Input | | | | | | | | | | | | | | | | | | | | | | | | | | |
| Motor Rotational Speed | - | | | | | | | | | | | | | | | | | | | | | | | | | | |
| Position Error | - | | | | | | | | | | | | | | | | | | | | | | | | | | |
| Motion Complete | MEND (Output) | | | | | | | | | | | | | | | | | | | | | | | | | | |

5. Position Control Mode

| Item | Valid or Invalid | Setting | Units |
|------|------------------|-----------------|-------|
| | | Enable, Disable | [-] |

This Parameter indicates whether motion per a point number is enabled or disabled.

| Setting |
|---|
| Disable: The motion per the point number will not be executed and any subsequent point numbers that are enabled will be executed. |
| Enable: The motion per the point number will be executed. |

If you start with a point number that is “disabled”,
 The first subsequent point number that is “enabled” will be executed.

If a “disabled” point number is specified while one motion is being executed,
 Motion per the “disabled” point number will not be executed and motion per the first “enabled” point number among the subsequent ones will be executed.

If Dwell time = “0” for a point number assigned “continuous”
 The rotational speed will change continuously per “enabled” point numbers before/after the “disabled” point number.

Here is an example.
 With the Point Table settings below, if you specify Start signal input to Point No. “1”, Point No. 2 won't be executed and Point No. 1 and 3 will be continuously executed.

Description



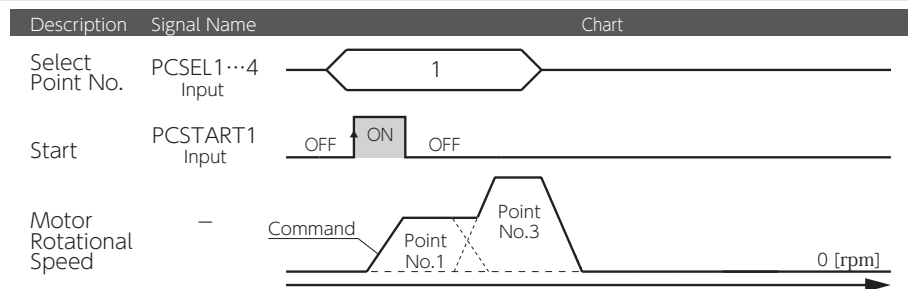

| Point No. | Running operation | Dwell Time | Enable/Disable |
|-----------|-------------------|------------|----------------|
| 1 | continuous | 0 | Enable |
| 2 | continuous | (optional) | Disable |
| 3 | single | (optional) | Enable |



TIP
 For a point number with “enable” to be the last motion, set Running Motion = “single”. Otherwise (i.e. “continuous” setting to the last point number), its “enable” setting will keep the motion end signal (MEND) off and the next motion instruction will be not be executed. If this happens, do one of the following.

- With User I/O
 Turn the servo off or input Clear Position error Counter.
- With Digitax SF Connect
 Turn the servo off or click the STOP button.

Precautions for Testing

| | | |
|---|---|---|
|  | Before applying power to each drive or motor, be sure that wiring has been performed correctly. |  |
| | Set the parameters correctly before testing. |  |
| | Check motor motion first with no machine connected. |  |
| | For a brake-equipped motor, be sure to disengage the brake before driving the motor. |  |

Testing

Using Digitax SF Connect, check motion per the point table that you created.

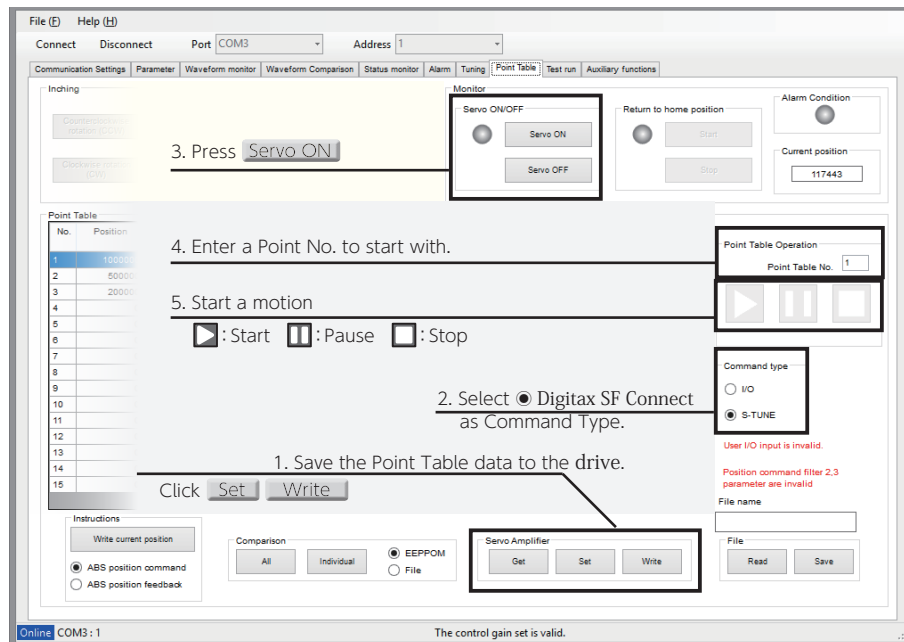

Operation by User I/O

Refer to the corresponding pages of the following five typical motion patterns to set up a point table.

| Motion Pattern | Refer to | |
|-------------------------------|---------------------------|---------|
| Single-motion positioning | Page 28 | |
| Continuous positioning motion | Page 29 | |
| Continuous speed changes | One-direction motion | Page 30 |
| | Opposite direction motion | Page 31 |
| Press motion | Page 32 | |

Procedure (Positioner operation by User I/O input)

| Step | Description | Explanation |
|---------------|-------------------------------|--|
| Step 1 | Check if ready to start. | Check if MEND is closed. If it's open, wait. |
| Step 2 | Select Point No. | Input PCSEL1...4 to specify a Point No. to execute. |
| Step 3 | Starting Positioner operation | Wait for at least 10ms after PCSEL1-4 input, and then change PCSTART1 from open to closed. Start driving the system according to the command per the point number specified. (*) |
| Step 4 | Check command execution | Wait till MEND becomes open. When MEND is open, change PCSTART1 back to open. |
| Step 5 | Check Operation Complete | Verify with MEND that the motion command execution is complete. MEND turning from open to closed indicates that the operation is complete. |

*) For more information about user I/O operation, refer to the timing diagrams shown in the operation examples.

5. Position Control Mode

Timing Diagram and Point Table Items

Create a point table entry for each motion command. Refer to the following timing diagram for single-motion.

Example of Point Table Setting (Single-Motion)

| No. | Position | Rotational Speed [rpm] | Acceleration Time [ms] | Deceleration Time [ms] | Dwell Time [ms] | Command Method | Running Motion | Positioning Complete [pulse] | Enable/Disable |
|-----|----------|------------------------|------------------------|------------------------|-----------------|----------------|----------------|------------------------------|----------------|
| 1 | 5,000 | 300 | 100 | 150 | 1 | Relative | single | (any value) | enable |

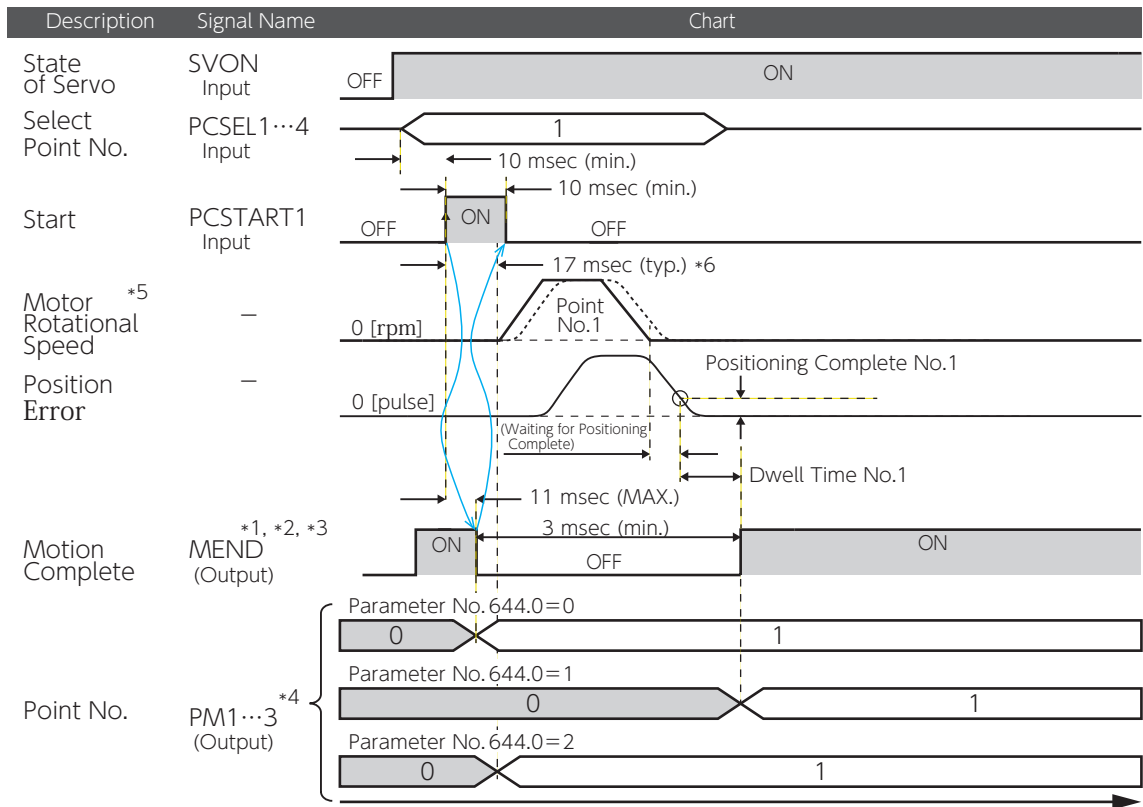

- * 1) If you want to check the motion end signal (MEND) with the User I/O output "MEND/T-LIMIT", turn T-LIMIT output OFF, by parameter configuration and TLSEL1 OFF. 👉 4 Connections User I/O
- * 2) The MEND output is OFF at Servo OFF.
- * 3) The PCSTART1 input is ignored when MEND output is OFF.
- * 4) This is enabled at the User I/O setting Option 1.
The Point No. output method depends on the [Point No. Output Method (No644.0)] setting at the time of PCSTART1 input.
- * 5) Any changes made to the point table setting during a motion will not be applied to the motion.
- * 6) The startup timing depends on other conditions.

5. Position Control Mode

Example of Operation 1 Single-Motion Positioning

Motor motion stops when motion per a selected point number ends if its Running Motion setting = single.

Example of Point Table Setting (Single-Motion Positioning)

| No. | Position | Rotational Speed [rpm] | Acceleration Time [ms] | Deceleration Time [ms] | Dwell Time [ms] | Command Method | Running Motion | Positioning Complete [pulse] | Enable/Disable |
|-----|----------|------------------------|------------------------|------------------------|-----------------|----------------|----------------|------------------------------|----------------|
| 1 | 5,000 | 300 | 100 | 150 | 100 | Absolute | Single | 20 | enable |
| 2 | 3,000 | 200 | 100 | 100 | 50 | Relative | Single | 20 | enable |

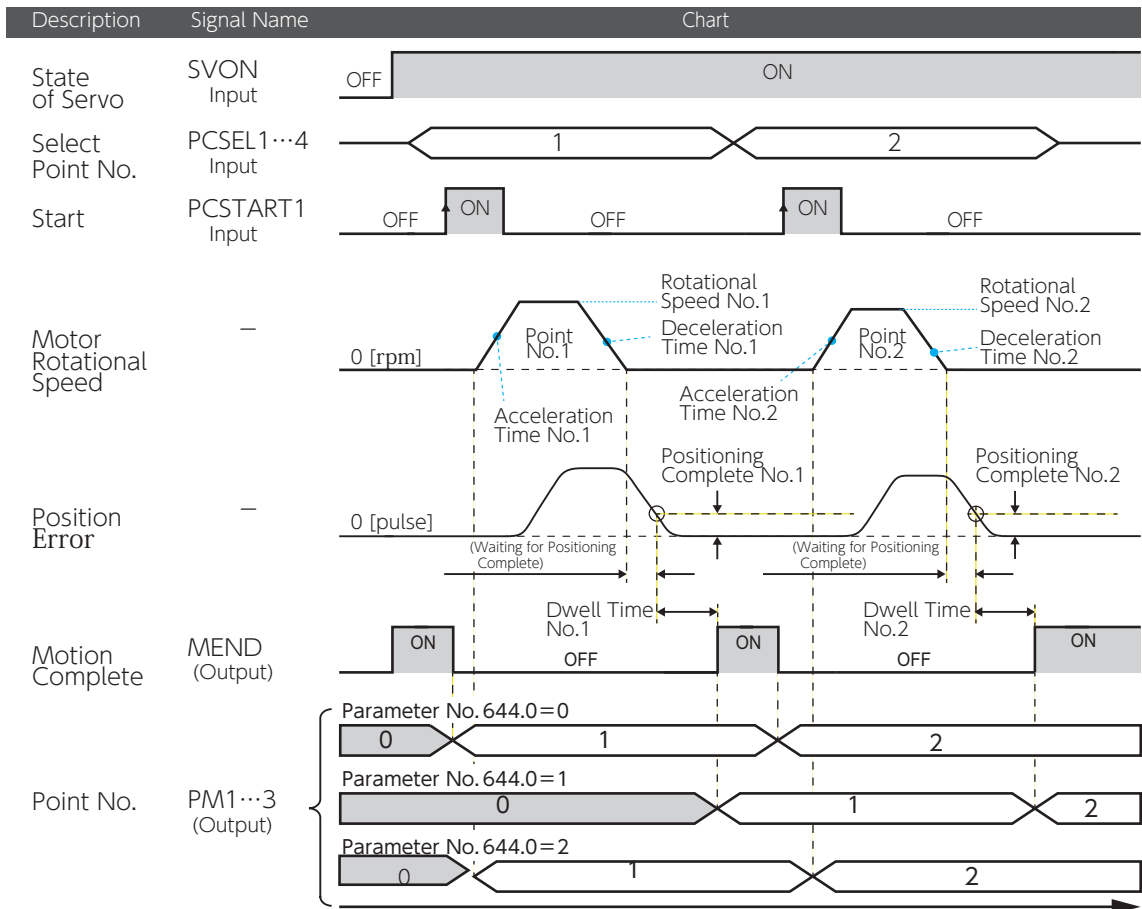

5. Position Control Mode

Example of Operation 2 Continuous Positioning Motion

This procedure executes a series of positioning motion following the point numbers in order. Set Running Motion of “enabled” point numbers to “continuous”, and specify the first point number for turning on the CW drive signal PCSTART1.

For this motion group, set Dwell Time = 1 ms or higher.

Example of Point Table Setting (Continuous Positioning Operations)

| No. | Position | Rotational Speed [rpm] | Acceleration Time [ms] | Deceleration Time [ms] | Dwell Time [ms] | Command Method | Running Motion | Positioning Complete [pulse] | Enable/Disable |
|-----|----------|------------------------|------------------------|------------------------|-----------------|----------------|----------------|------------------------------|----------------|
| 1 | 5,000 | 300 | 100 | 150 | 100 | Absolute | continuous | 20 | enable |
| 2 | -6,000 | 200 | 100 | 100 | 50 | Relative | Single | 20 | enable |

For the last “enabled” point number, set Running Motion = “single”.
the acceleration/deceleration setting of the first point number that is selected upon CW start PCSTART1 ON will be applied, and the settings of subsequent point numbers will be discarded.

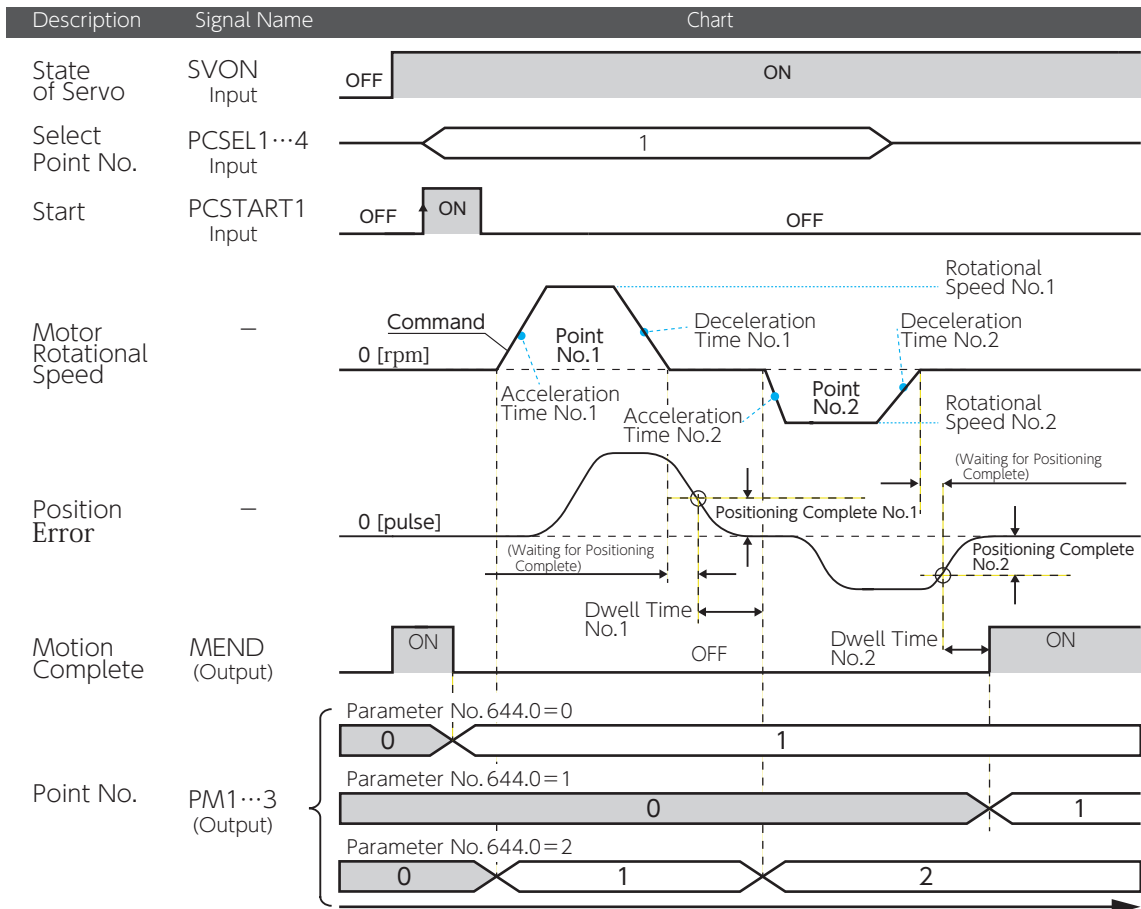

5. Position Control Mode

Example of Operation 3 Continuous Speed Changes (Positioning in One Direction)

This procedure executes a series of positioning motion following the point numbers in order. Motion instructions per point numbers are executed with no interruptions and the rotational speed changes continuously. Positioning motion will continue up to (not including) the point number whose Running Motion is “single” . Set Running Motion of all enabled point numbers to “continuous” , and specify the first point number for turning on CW drive signal PCSTART1.

For this motion group, set Dwell Time = 1 ms.

Example of Point Table Setting (for motion with continuous speed changes in one direction)

| No. | Position | Rotational Speed [rpm] | Acceleration Time [ms] | Deceleration Time [ms] | Dwell Time [ms] | Command Method | Running Motion | Positioning Complete [pulse] | Enable/Disable |
|-----|----------|------------------------|------------------------|------------------------|-----------------|----------------|----------------|------------------------------|----------------|
| 1 | 5,000 | 200 | 100 | 200 | 0 | Relative | continuous | 20 | enable |
| 2 | 3,000 | 300 | (disable) | (disable) | 0 | Relative | continuous | 20 | enable |
| 3 | 2,000 | 100 | (disable) | (disable) | 20 | Relative | Single | 20 | enable |

For the last enabled point number, set Running Motion = “single” .

If Dwell Time = 0, the acceleration/deceleration setting of the first point number that is selected upon CW start PCSTART1 ON will be applied, and the settings of subsequent point numbers will be discarded.

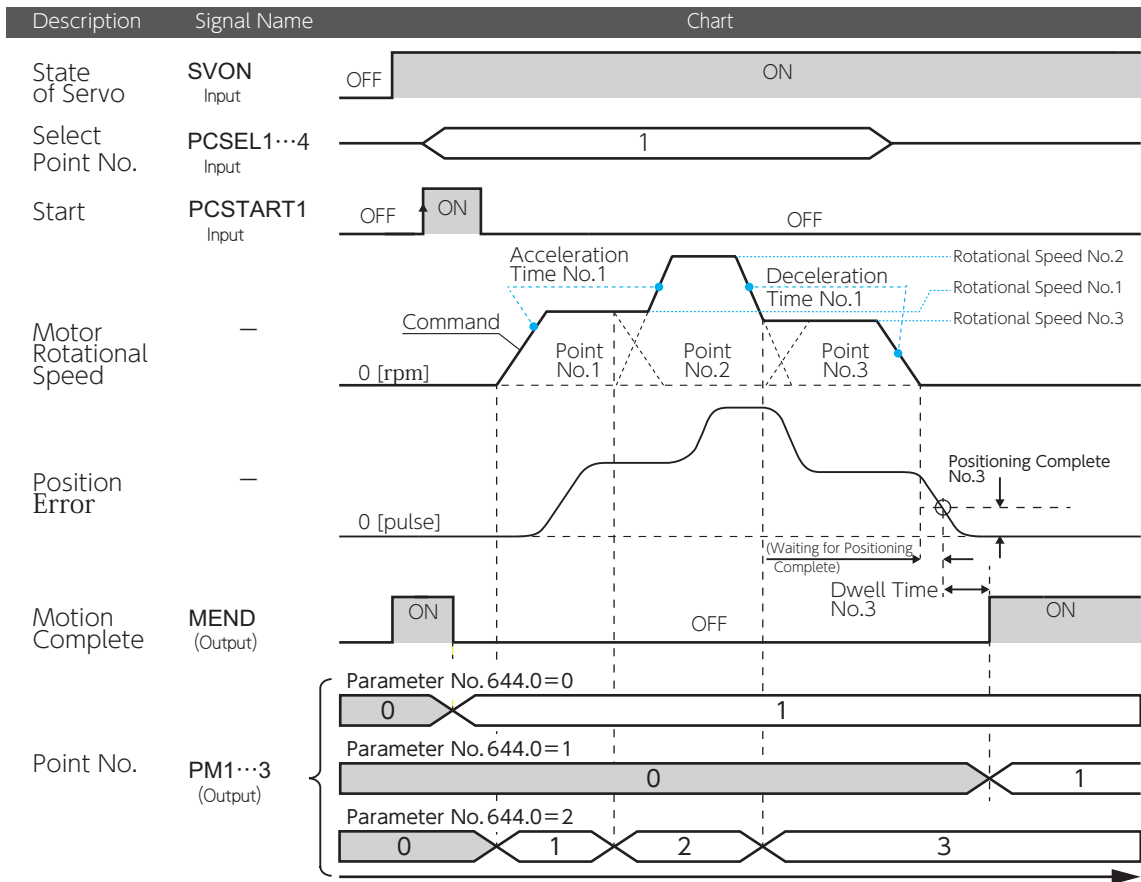

5. Position Control Mode

Example of Operation 4 Continuous Speed Changes (Positioning in the Opposite Direction)

This procedure executes a series of positioning motion following the point numbers in order. Motion instructions per point numbers are executed with no interruptions and the rotational speed changes continuously. Positioning motion will continue up to (not including) the point number whose Running Motion is "single". Set Running Motion of all enabled point numbers = "continuous", and specify the first point number for turning on CW drive signal PCSTART1.

For this motion group, set Dwell Time = 0 ms.

Example of Point Table Setting (for motion with continuous speed changes in reverse direction)

| No. | Position | Rotational Speed [rpm] | Acceleration Time [ms] | Deceleration Time [ms] | Dwell Time [ms] | Command Method | Running Motion | Positioning Complete [pulse] | Enable/Disable |
|-----|----------|------------------------|------------------------|------------------------|-----------------|----------------|----------------|------------------------------|----------------|
| 1 | 5,000 | 300 | 100 | 200 | 0 | Relative | continuous | 20 | enable |
| 2 | 3,000 | 200 | (disable) | (disable) | 0 | Relative | continuous | 20 | enable |
| 3 | -4,000 | 100 | (disable) | (disable) | 20 | Relative | single | 20 | enable |

For the last enabled point number, set Running Motion = "single".

The acceleration/deceleration setting of the first point number that is selected upon CW start PCSTART1 ON will be applied, and the settings of subsequent point numbers will be discarded.

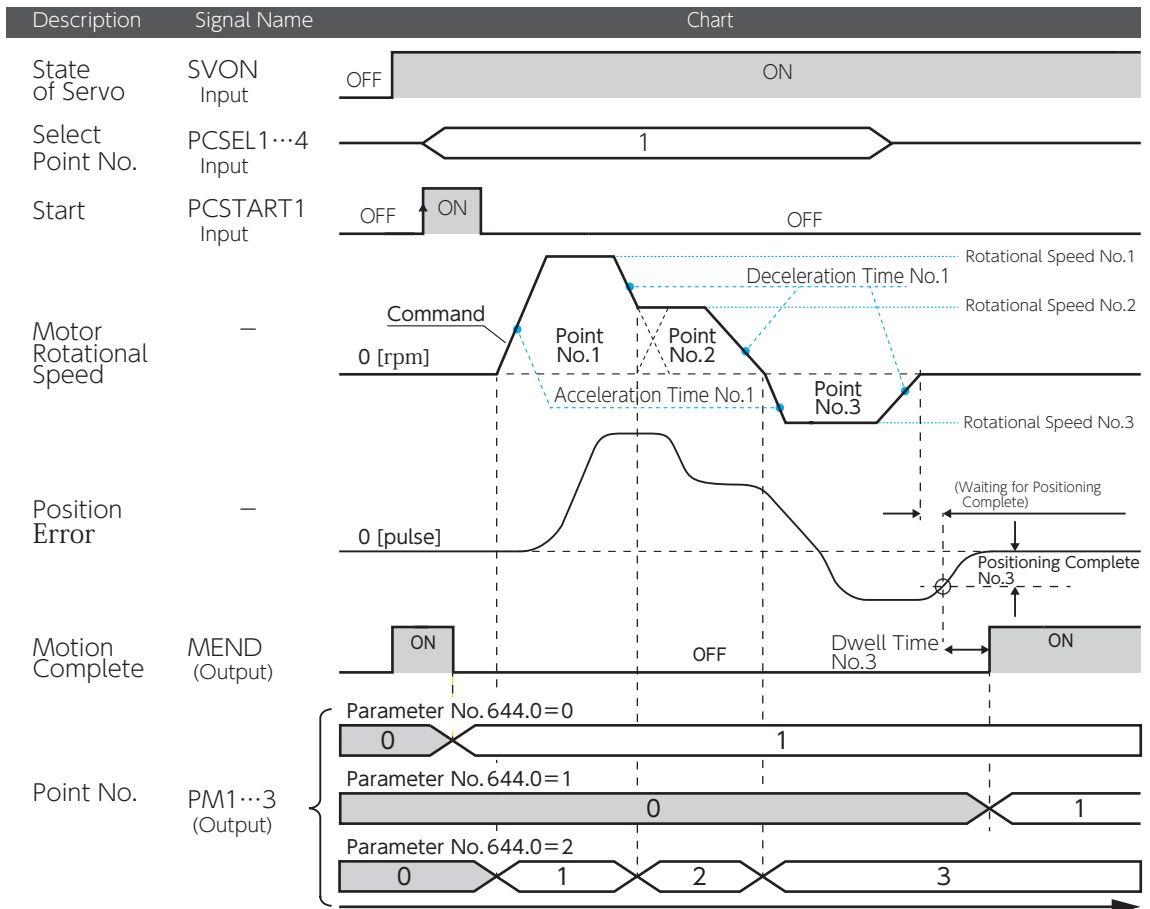

Example of Motion 5 Press Motion

This operation involves motion to approach a workpiece at high speed, then execute a press motion to the workpiece after changing the values of speed and torque. You can use this type of operation only when User I/O is the Optional I/O Configurations.

Set the following parameters.

| Name | | Explanation | Parameter No. |
|--|------------|--|---------------|
| | Switch | Set to 1 (enable). | 144.0 |
| Torque command limit | Value 1 | Set the torque limit value for motion of approaching the workpiece at high speed and leaving the workpiece. | 147.0 |
| | Value 2 | Set the torque command limit to be applied at the time of press-to-workpiece motion. | 148.0 |
| Torque limiting output | | 2: Set [Torque command limit: Value 2 (No.148.0)] = Enable | 144.1 |
| | Switch | Enable/Disable the function to detect position error. | 65.0 |
| Position Error Detection | Value | To let the detection function work, set a value larger than the distance between the target location of press motion and the workpiece. | 87.0 |
| | Delay time | Specify how long a position error waits to be output after position error exceeds the [Position error detection: Value (No.87.0)] setting. | 89.0 |
| Speed Error Detection | Switch | Enable/Disable the function to detect speed error. | 65.1 |
| | Value | Specify at what speed error value the error is to be detected. | 90.0 |
| | Delay time | Specify how long a speed error waits to be output after the speed error exceeds the [Speed error detection: Value (No.90.0)] setting. | 91.0 |
| Point Table Point Number Output Method | | Set to 2: output the point number at its motion start. | 644.0 |



5. Position Control Mode

The following example illustrates Point Table settings with Point No.1 (P1) for motion of approaching a workpiece, Point No.2 (P2) for motion of pressing the workpiece, Point No.3 (P3) for motion of parting from the workpiece.

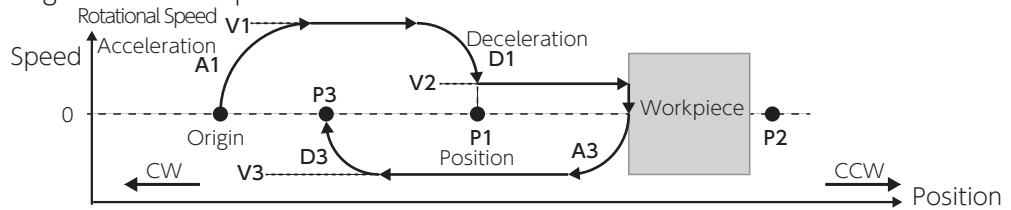

Example of Point Table Setting (Press Motion)

| No. | Position | Rotational Speed [rpm] | Acceleration Time [ms] | Deceleration Time [ms] | Dwell Time [ms] | Command Method | Running Motion | Positioning Complete [pulse] | Enable/Disable |
|-----|----------|------------------------|------------------------|------------------------|-----------------|----------------|----------------|------------------------------|----------------|
| 1 | (P1) | (V1) | (A1) | (D1) | 0 | Absolute | continuous | 0 | enable |
| 2 | (P2) | (V2) | (disable) | (disable) | (disable) | Absolute | Single | 0 | enable |
| 3 | (P3) | (V3) | (A3) | (D3) | (any value) | Absolute | Single | (any value) | enable |

- P1: Specify the target location with high-speed approach.
- V1: Specify the speed of approaching to the workpiece.
- P2: Specify the location across the workpiece.
- V2: Specify the speed of pressing the workpiece.
- P3: Destination

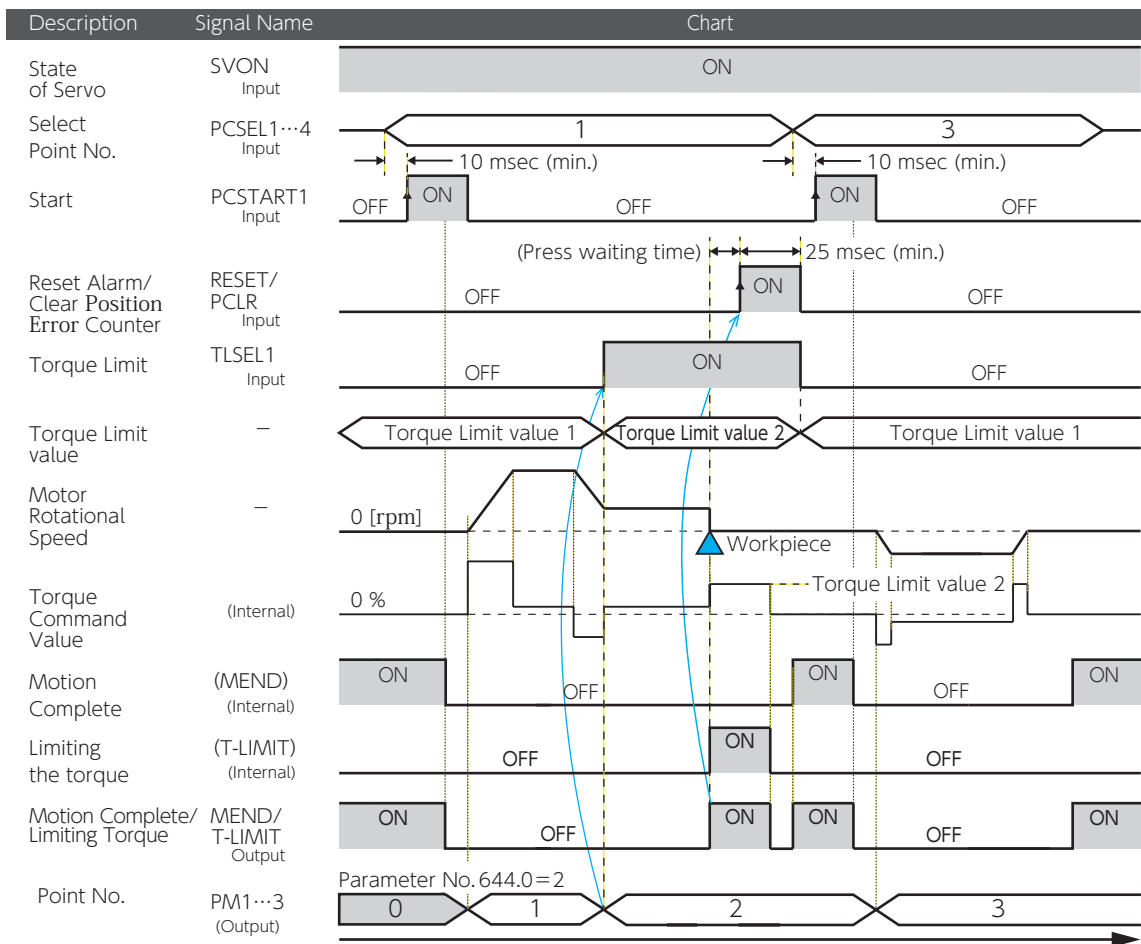

Procedure for Press Motion

| Step | Operation |
|----------------|--|
| | Check if ready to start. |
| Step 1 | Open TLSEL1 and select Torque Limit 1 as torque limit value. Verify that MEND/T-LIMIT is closed. Wait if it's open. |
| |  Page 24 Valid or Invalid |
| Step 2 | Select Point No. Input the point number for approach-to-workpiece motion to PCSEL1...3. (Point No.1 in this example) |
| | Start Point Table Motion |
| Step 3 | Wait for at least 10 ms after input of PCSEL1...3, and then change the PCSTART1 status from open to closed. The motion starts per the setting of the point number specified. |
| Step 4 | Check command execution Wait until MEND/T-LIMIT becomes open. If it's open, reset PCSTART1 to open. |
| | Verify the start Point No. |
| Step 5 | Verify the point number that was started by the PM1...3 input. When the point number of Press motion is output (No.2 in this example), close TLSEL1, and select Torque Limit Value 2 as the torque limit value. |
| Step 6 | Check Torque Limit Status Check the torque limit status with MEND/T-LIMIT and wait until it becomes closed. |
| | Clear Position Error Counter |
| Step 7 | After MEND/T-LIMIT becomes closed, wait for the desired press time, then close RESET/PCLR to execute Clear Position Error Counter. Wait for at least 25 ms after RESET/PCLR, input, and then reset RESET/PCLR to open. |
| Step 8 | Check if ready to start. Open TLSEL1 and select Torque Limit 1 as the torque limit value. Verify that MEND/T-LIMIT is closed. |
| Step 9 | Select Point No. Input a point number for the leaving-workpiece motion to PCSEL1...3. (No.3 in this example) |
| | Start Point Table Motion |
| Step 10 | Wait for at least 10 ms after input of PCSEL1...3, and then change the PCSTART1 status from open to closed. Motion starts according to the specified Point No. settings. |
| Step 11 | Check command execution Wait until the MEND/T-LIMIT becomes open. If it's open, change PCSTART1 back to open. |
| Step 12 | Check Operation Complete Verify with MEND/ T-LIMIT that the motion command execution is complete. MEND/T-LIMIT turning from open back to closed indicates that the motion is complete. |

2. Homing

Homing is an operation to align the relative position in the drive parameters and the actual mechanical position of the machine. When you are using the Positioner function of the drive, perform homing, as necessary.

In incremental systems:

homing is necessary every time the system is powered on.

In absolute systems:

encoder data is retained by the backup battery. Once you perform homing at the time of installation, homing is unnecessary at power on even after the control power turns off.

 9 Appendices Absolute System

■ Homing Methods

| | |
|--------------------|---------|
| User I/O input | Page 36 |
| Digitax SF Connect | Page 37 |

■ Types of Homing

There are three patterns of homing.

Select the parameters to set depending on the motion patterns that you need for homing.

| | |
|-------------------------|---------|
| User-Specified Position | Page 40 |
| Press (Stopper) | Page 42 |
| Home Sensor (*) | Page 44 |

*) To perform Homing by using Home Sensor, use I/O input. Digitax SF Connect does not support Homing with Home Sensor.

Precautions

Homing based on home position sensor front-end

Install the home position sensor at the machine-end. Set [HOMING: Movement direction (No.646.0)] to the direction of moving from the front of the sensor towards the sensor-front-end.

Setting the homing direction to the leaving-sensor direction (to the left of sensor below) may result in a collision to the machine end.

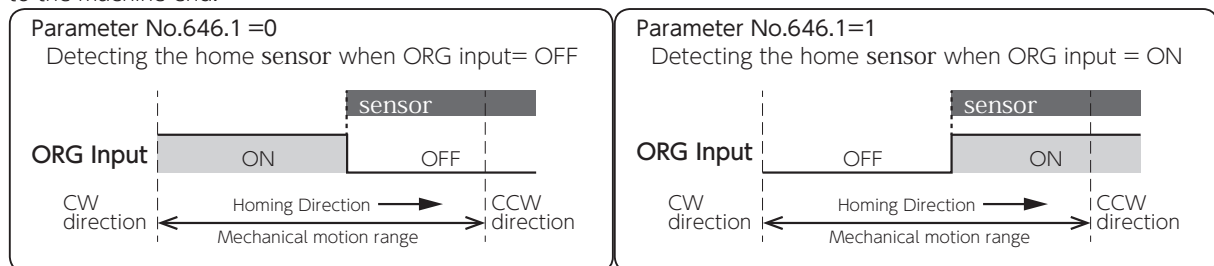
If you changed the command paired-pulse ratio value,

perform homing again after saving the parameters and power cycling.

If you execute Homing by using encoder Z-phase,

configure the start point of Z-phase detection not close to motor Z-phase. Otherwise, the detection position of Z-phase may become inconsistent. The Z-phase position can be checked by the position where the "encoder single-turn data" becomes 0.

If any of the following occur during the homing motion,

homing will be interrupted resulting in a Homing Incomplete state.

- Servo turns off.
- Clear Position Error Counter is executed. When Clear Position Error Counter is executed, the motor will make a quick stop.
- Drive Limit Switch Input is active and Clear Position Error Counter is executed.

Homing with User I/O Input

Required Parameters

Set the operation mode.

| Parameter No. | Name | Setting |
|---------------|----------------------------------|---------------------------------------|
| 2.0 | Control Mode | 0: Position Control Mode |
| 3.0 | Command Mode | 3: Internal Command Mode |
| 9.0 | Operation Mode (*) | 0: I/O input 1: Digitax SF Connect |
| 642.0 | Internal Position Operation Mode | 0 : Point Table |

*) Operation Mode (No.9.0) = 0 (I/O) upon drive power on.
The Setup Panel does not support display or setup of Operation Mode.

| Step | Operation |
|---------------|--|
| Step 1 | <p>Set Homing related parameter values</p> <p>Set the values of Homing Speed, Homing Creep Speed, and Homing Acceleration/Deceleration Time.</p> |
| Step 2 | <p>Check if Homing can be started.</p> <p>Check if MEND is closed. If it's open, wait.</p> |
| Step 3 | <p>Specify the Point Number (in the standard I/O setting only)</p> <p>Open all four of PCSEL1...4 to specify Point No.0. (This step is not necessary for the Option I/O setting.)</p> |
| Step 4 | <p>Start Homing motion</p> <p>Verify that MEND is closed in a servo-on state, and then start Homing. If MEND is open in a servo-on state, the start command will not be accepted.</p> <p>In Standard I/O Setting Close PCSTART1 input. (at least 10 ms after Step 3)</p> <p>In Option I/O Setting Set HOME to closed. (at least 10 ms after Step 3)</p> |
| Step 5 | <p>Check Command Execution</p> <p>Wait for MEND to become open. Open PCSTART or HOME after verifying that MEND is open.</p> |
| Step 6 | <p>Check Operation Complete</p> <p>Use MEND to see if the motion command execution is complete. MEND turning from open to closed indicates that the motion is complete.</p> |
| Step 7 | <p>Check Homing Complete</p> <p>After the motion is complete, use HEND to see if Homing is complete. HEND turning from open to closed indicates that the homing procedure is complete.</p> |

Homing with Digitax SF Connect

Required Parameters

Set the operation mode.

| Parameter No. | Name | Setting |
|---------------|----------------------------------|---------------------------------------|
| 2.0 | Control Mode | 0: Position Control Mode |
| 3.0 | Command Mode | 3: Internal Command Mode |
| 9.0 | Operation Mode (*) | 0: I/O input 1: Digitax SF Connect |
| 642.0 | Internal Position Operation Mode | 0: Point Table |

*) Operation Mode (No.9.0) = 0 (I/O) upon drive power on.
The Setup Panel does not support display or setup of Operation Mode.

1. Parameter Tab
Setting homing parameters

2. Point Table Tab
Click Servo ON
(Have the motor in a Servo-ON state)

3. Click Start to start homing

- Click Pause to pause homing
- When homing is completed, the indicator to the left of the Start button will turn green and the Current position cell will show the current position resulting from homing.

5. Position Control Mode

Timing diagram

The following illustrates how to perform Homing with User I/O Input. Homing based on home-sensor-front-end is used in the example below.

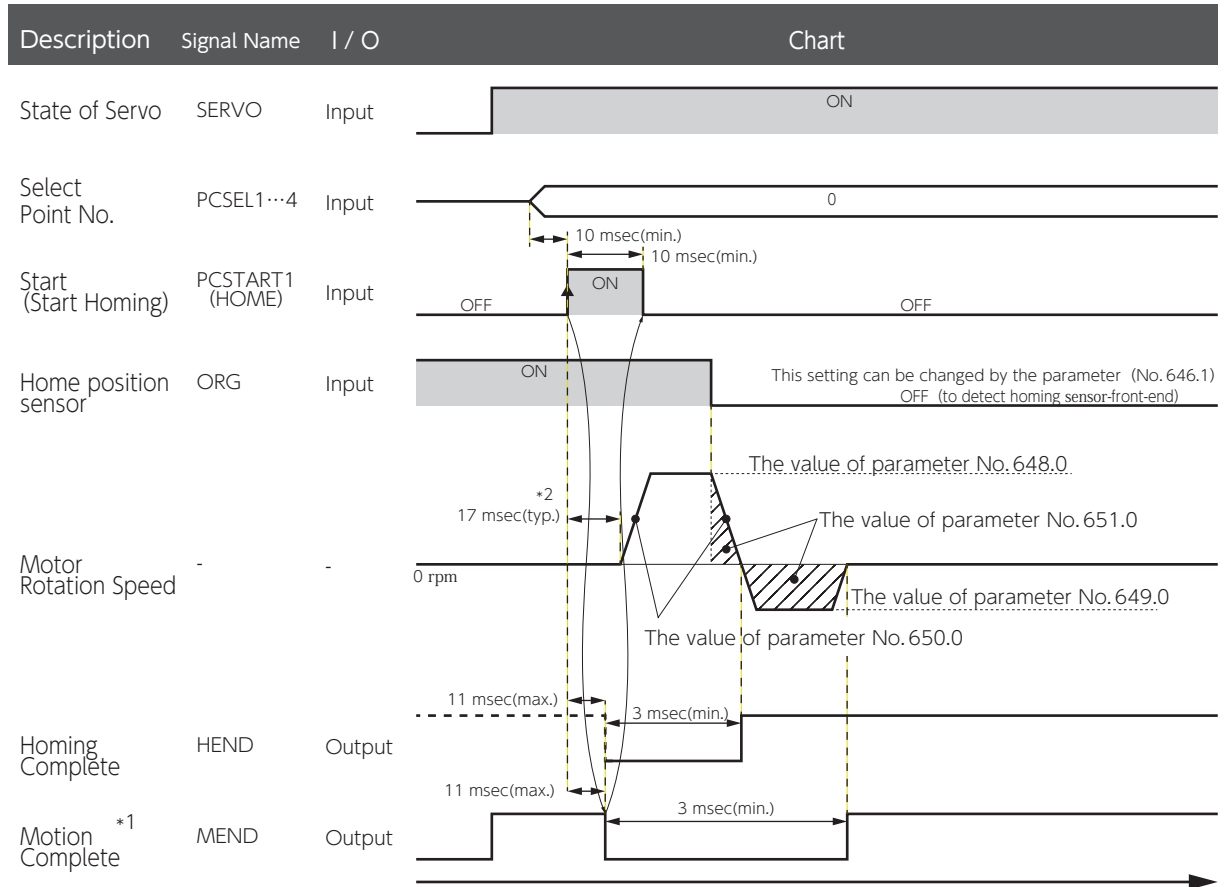

*1) If you want to check the operation end signal (MEND) with the User I/O output "MEND/T-LIMIT", turn T-LIMIT output OFF, by parameter configuration and TLSEL1 OFF.

*2) The startup timing depends on other conditions.

Types of Homing Motion

Homing movement comprises two segments: Rough Approach and Careful Approach. Specify the motion type by configuring multiple parameters differently.

$$\text{Homing} = \text{Rough Approach (Lunge motion)} + \text{Careful Approach (Creep motion)}$$

Rough Approach (Lunge motion)

Indicates a motion type to detect the stopper or the sensor. Configure this part of homing so that homing will be as accurate as possible in the second segment of homing.

Careful Approach (Creep motion)

Indicates a motion type to approach the home position slowly and accurately after the detection of stopper, sensor or base signal.

This motion group includes the following:

- motion to detect Z-phase
- travel over the Z-phase disabled distance
- movement from the base to home after base signal detected.
- motion to detect the sensor again
- motion after re-detecting the sensor

How to read homing motion patterns

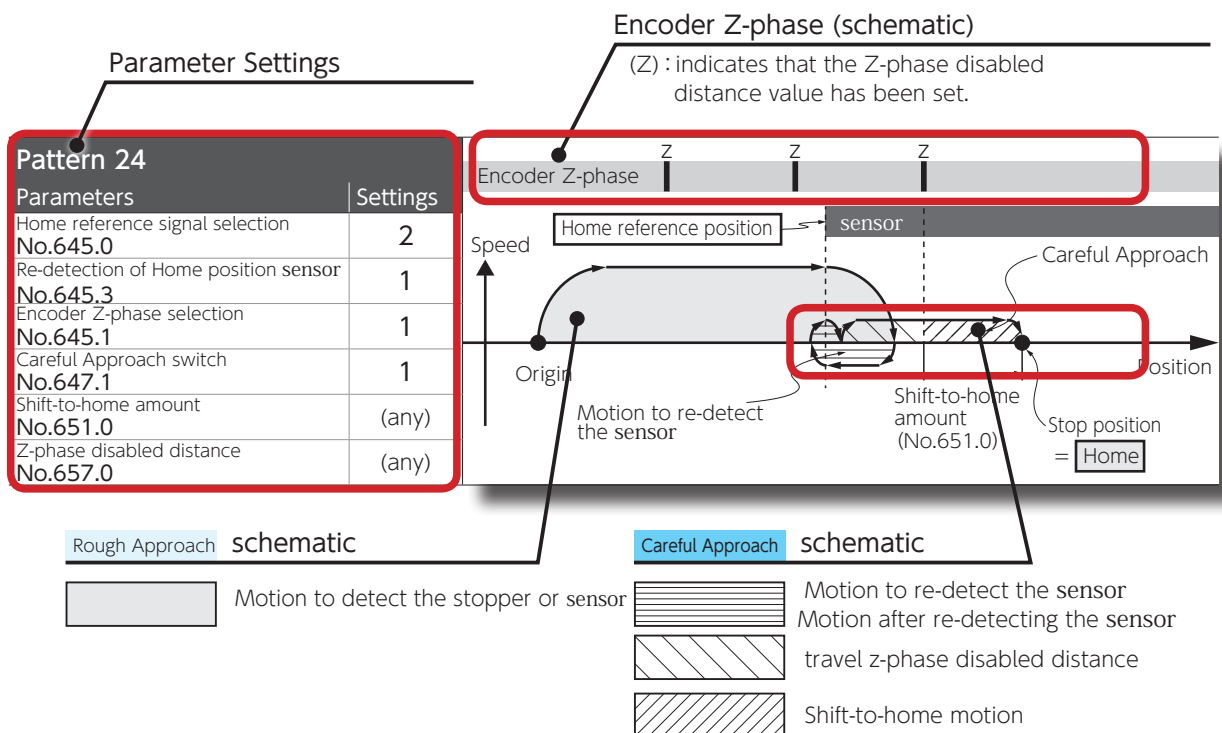

5. Position Control Mode

Homing Based on User-Specified Position (No.645.0=0)

This operation indicates the type of homing based on the starting point.

This type of homing operation enables you to specify any position as the home position without turning the servo on, for example, by manually moving the machine to any desired home position. In addition, this method enables the encoder z-phase to be detected without involving stopper or sensor

This type of homing does not involve the Rough Approach motion group.

Set the following related parameters.

| Group | Name | Parameter No. |
|------------------|---|---------------|
| Homing Overall | Home reference signal selection (arbitrary position, stopper, sensor) | 645.0 (*) |
| | Movement direction | 646.0 |
| | Acceleration/Deceleration time (Common in Rough approach speed and Careful approach speed) | 650.0 |
| | Home position data | 653.0 |
| Careful approach | Careful approach switch | 647.1 (*) |
| | Encoder Z-phase Selection | 645.1 (*) |
| | Z-phase disabled distance | 657.0 (*) |
| | Careful approach speed | 649.0 |
| Common | Amount of position shift to home (travel distance from base signal or z-phase to home) | 651.0 |
| | Internal Position - Motion of Point No.0 | 646.3 |
| | Homing: Torque command limit | 647.0 |
| | Homing: Timeout Switch | 646.2 |
| | Homing: Timeout Time | 659.0 |

*) Parameters to define the homing pattern

Refer to the patterns from 1 to 6 below to set the parameters.

| Pattern 1 | | Speed | Position |
|---|----------|-------|----------|
| Parameters | Settings | | |
| Home reference signal selection No.645.0 | 0 | | |
| Encoder Z-phase selection No.645.1 | 0 | | |
| Careful Approach switch No.647.1 | 0 | | |
| Shift-to-home amount No.651.0 | 0 | | |
| Z-phase disabled distance No.657.0 | 0 | | |
| | | | |
| | | | |

5. Position Control Mode

| Pattern 2 | |
|---|----------|
| Parameters | Settings |
| Home reference signal selection No.645.0 | 0 |
| Encoder Z-phase selection No.645.1 | 0 |
| Careful Approach switch No.647.1 | 1 |
| Shift-to-home amount No.651.0 | (any) |
| Z-phase disabled distance No.657.0 | 0 |

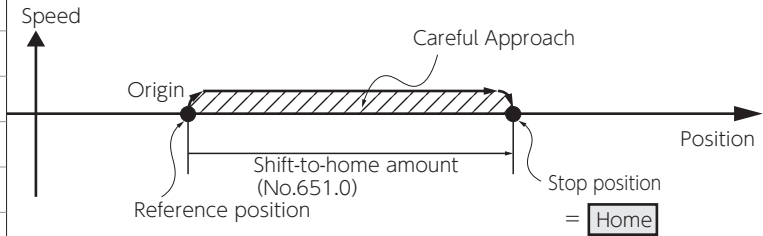

| Pattern 3 | |
|---|----------|
| Parameters | Settings |
| Home reference signal selection No.645.0 | 0 |
| Encoder Z-phase selection No.645.1 | 1 |
| Careful Approach switch No.647.1 | 1 |
| Shift-to-home amount No.651.0 | 0 |
| Z-phase disabled distance No.657.0 | 0 |

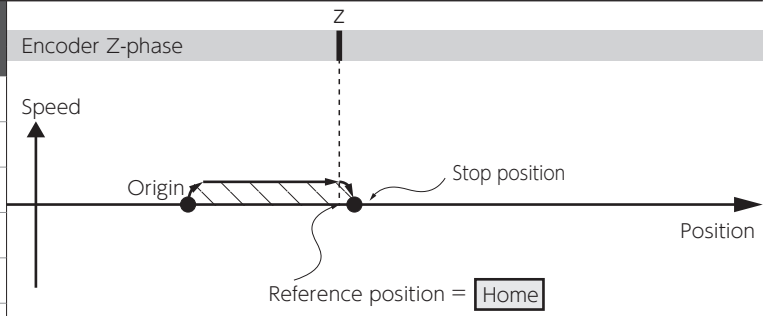

| Pattern 4 | |
|---|----------|
| Parameters | Settings |
| Home reference signal selection No.645.0 | 0 |
| Encoder Z-phase selection No.645.1 | 1 |
| Careful Approach switch No.647.1 | 1 |
| Shift-to-home amount No.651.0 | (any) |
| Z-phase disabled distance No.657.0 | 0 |

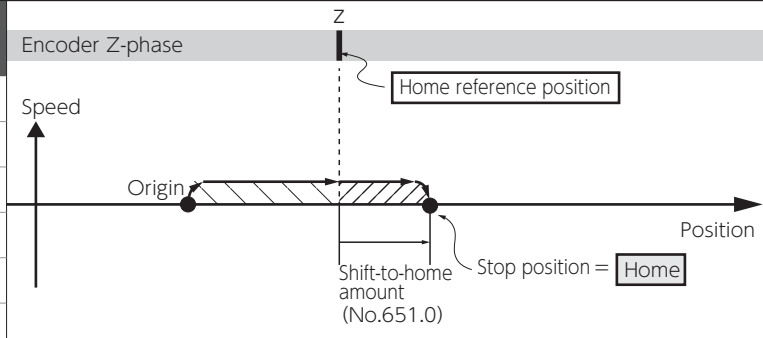

| Pattern 5 | |
|---|----------|
| Parameters | Settings |
| Home reference signal selection No.645.0 | 0 |
| Encoder Z-phase selection No.645.1 | 1 |
| Careful Approach switch No.647.1 | 1 |
| Shift-to-home amount No.651.0 | 0 |
| Z-phase disabled distance No.657.0 | (any) |

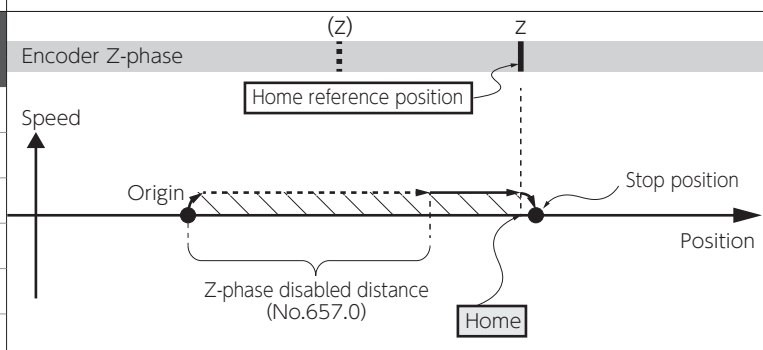

| Pattern 6 | |
|---|----------|
| Parameters | Settings |
| Home reference signal selection No.645.0 | 0 |
| Encoder Z-phase selection No.645.1 | 1 |
| Careful Approach switch No.647.1 | 1 |
| Shift-to-home amount No.651.0 | (any) |
| Z-phase disabled distance No.657.0 | (any) |

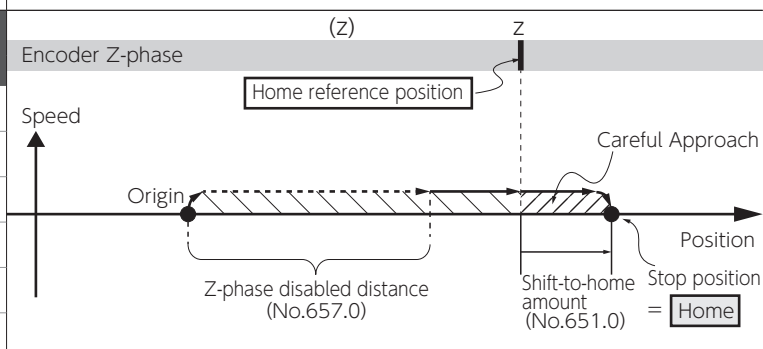

5. Position Control Mode

Homing based on Press (Stopper) (No.645.0=1)

This operation indicates the type of homing based on the stopper position.

You can use this type of homing by setting the home based on the position of the stopper being pressed per the motor movement.

There are three options to define home" (after detection of stopper pressed motion): 1) stopper position, 2) encoder z-phase, 3) user-specified position shifted from stopper or z-phase.

Set the following parameters related to this type of homing.

| Group | Name | Parameter No. |
|------------------|---|---------------|
| Homing Overall | Home reference signal selection (arbitrary position, stopper, sensor) | 645.0 (*) |
| | Movement direction | 646.0 |
| | Acceleration/Deceleration time (Common in Rough approach speed and Careful approach speed) | 650.0 |
| | Home position data | 653.0 |
| Rough approach | Rough approach speed | 648.0 |
| | Stopper pressed detection time | 655.0 |
| | Torque command limit: Value | 656.0 |
| Careful approach | Careful approach switch | 647.1 (*) |
| | Encoder Z-phase Selection | 645.1 (*) |
| | Z-phase disabled distance | 657.0 (*) |
| | Careful approach speed | 649.0 |
| Common | Amount of position shift to home (travel distance from base signal or z-phase to home) | 651.0 (*) |
| | Internal Position: Motion of Point No.0 | 646.3 |
| | Homing: Torque command limit | 647.0 |
| | Homing: Timeout Switch | 646.2 |
| | Homing: Timeout Time | 659.0 |

*) Parameters to define the homing patterns

Refer to the patterns 7 to 12 to configure the parameters.

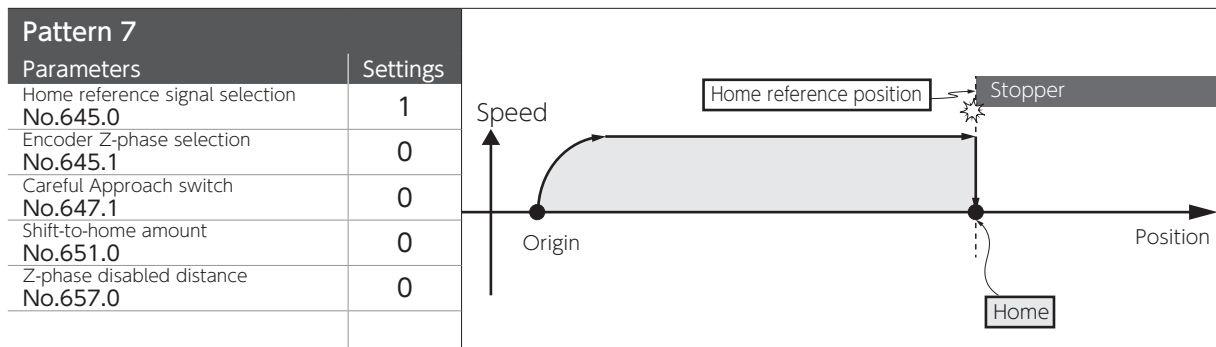

5. Position Control Mode

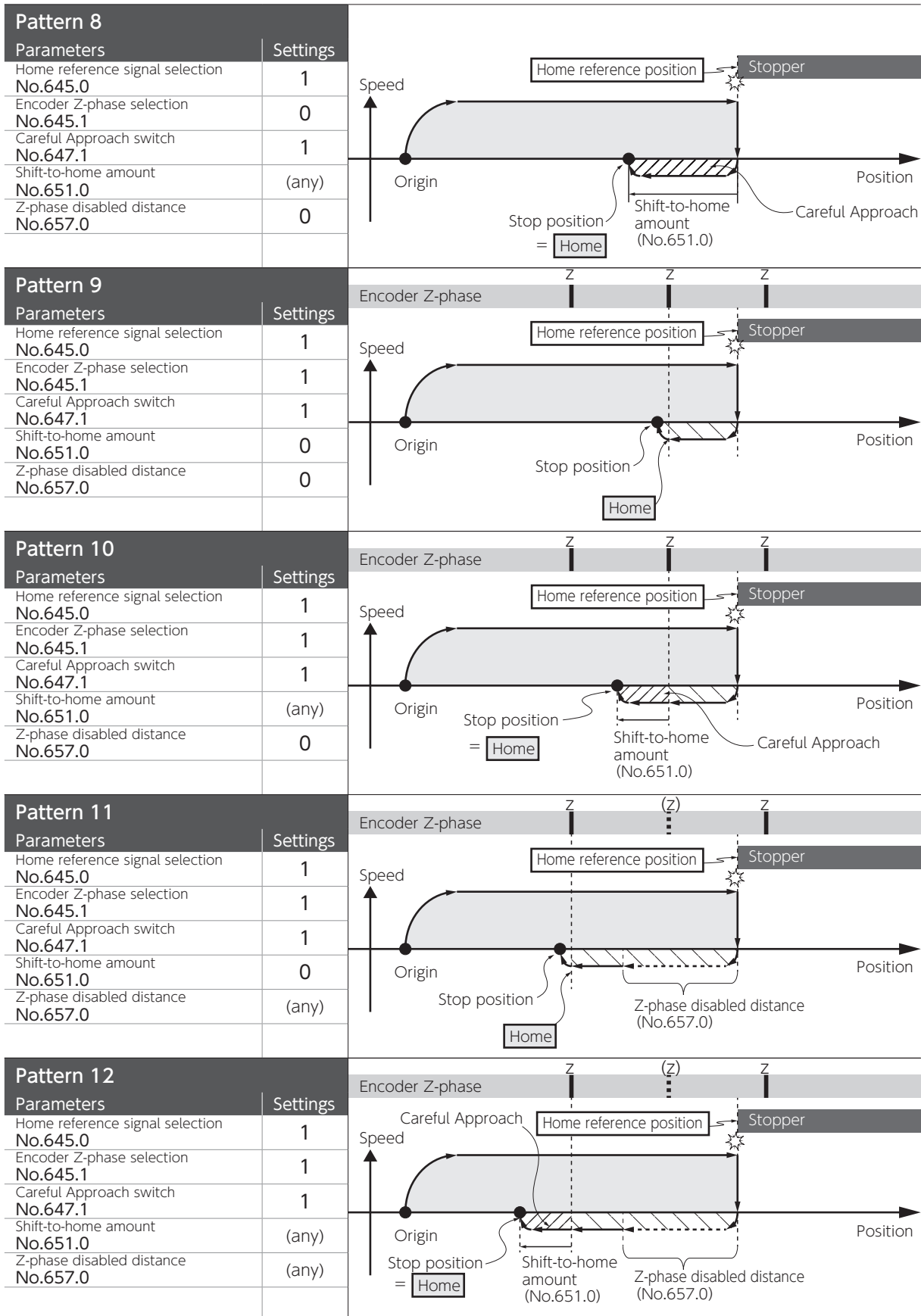

5. Position Control Mode

Homing Based on Home Sensor (no sensor re-detection) (No.645.0=2, No.645.3=0)

This operation indicates the type of homing based on the home position sensor.

no detection of the sensor-front-end after the first detection

You can use this type of homing to set the point of machine passing the sensor as the home base.

There are three options for what to be set as "home" (after detection of passing the sensor): 1)

sensor position, 2) encoder z-phase, 3) any position shifted from sensor or z-phase.

Set the following parameters related to this homing method.

| Group | Name | Parameter No. |
|------------------|---|---------------|
| Homing Overall | Home reference signal selection (arbitrary position, stopper, sensor) | 645.0 (*) |
| | Movement direction | 646.0 |
| | Acceleration/Deceleration time (Common in Rough approach speed and Careful approach speed) | 650.0 |
| | Home position data | 653.0 |
| Rough approach | Sensor polarity | 646.1 |
| | Rough approach speed | 648.0 |
| Careful approach | Careful approach switch | 647.1 (*) |
| | Encoder Z-phase Selection | 645.1 (*) |
| | Z-phase disabled distance | 657.0 (*) |
| | Re-detection of home position sensor | 645.3 (*) |
| | Careful approach speed | 649.0 |
| Common | Amount of position shift to home (travel distance from base signal or z-phase to home) | 651.0 (*) |
| | Internal Position: Motion of Point No.0 | 646.3 |
| | Homing: Torque command limit | 647.0 |
| | Homing: Timeout Switch | 646.2 |
| | Homing: Timeout Time | 659.0 |

*) Parameters to define the homing patterns

Refer to the patterns from 13 to 18 below to set the parameters.

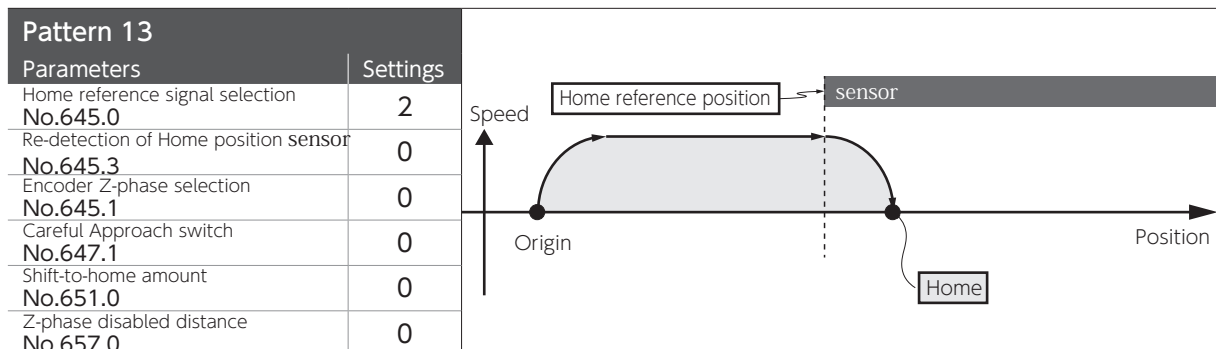

5. Position Control Mode

| Pattern 14 | |
|--|----------|
| Parameters | Settings |
| Home reference signal selection No.645.0 | 2 |
| Re-detection of Home position sensor No.645.3 | 0 |
| Encoder Z-phase selection No.645.1 | 0 |
| Careful Approach switch No.647.1 | 1 |
| Shift-to-home amount No.651.0 | (any) |
| Z-phase disabled distance No.657.0 | 0 |

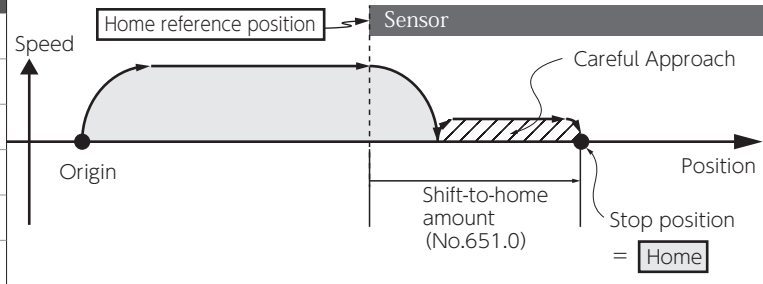

| Pattern 15 | |
|--|----------|
| Parameters | Settings |
| Home reference signal selection No.645.0 | 2 |
| Re-detection of Home position sensor No.645.3 | 0 |
| Encoder Z-phase selection No.645.1 | 1 |
| Careful Approach switch No.647.1 | 1 |
| Shift-to-home amount No.651.0 | 0 |
| Z-phase disabled distance No.657.0 | 0 |

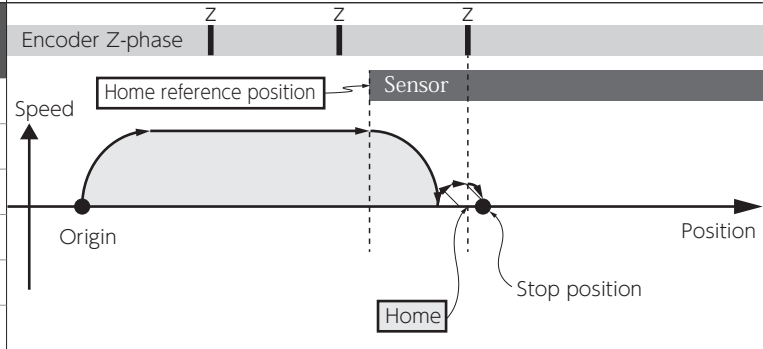

| Pattern 16 | |
|--|----------|
| Parameters | Settings |
| Home reference signal selection No.645.0 | 2 |
| Re-detection of Home position sensor No.645.3 | 0 |
| Encoder Z-phase selection No.645.1 | 1 |
| Careful Approach switch No.647.1 | 1 |
| Shift-to-home amount No.651.0 | (any) |
| Z-phase disabled distance No.657.0 | 0 |

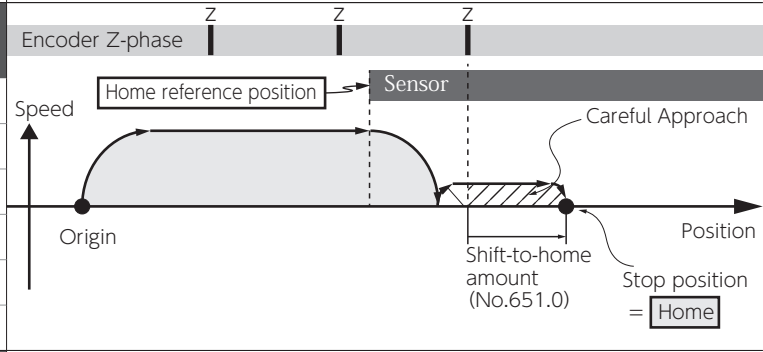

| Pattern 17 | |
|--|----------|
| Parameters | Settings |
| Home reference signal selection No.645.0 | 2 |
| Re-detection of Home position sensor No.645.3 | 0 |
| Encoder Z-phase selection No.645.1 | 1 |
| Careful Approach switch No.647.1 | 1 |
| Shift-to-home amount No.651.0 | 0 |
| Z-phase disabled distance No.657.0 | (any) |

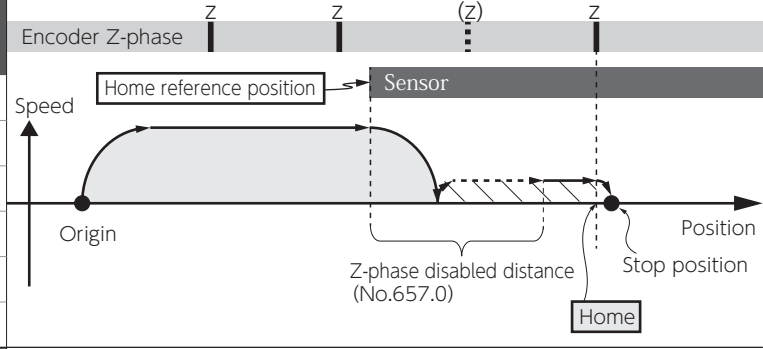

| Pattern 18 | |
|--|----------|
| Parameters | Settings |
| Home reference signal selection No.645.0 | 2 |
| Re-detection of Home position sensor No.645.3 | 0 |
| Encoder Z-phase selection No.645.1 | 1 |
| Careful Approach switch No.647.1 | 1 |
| Shift-to-home amount No.651.0 | (any) |
| Z-phase disabled distance No.657.0 | (any) |

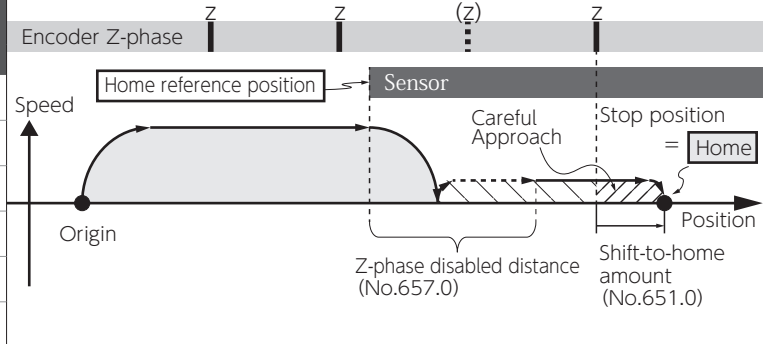

Homing Based on Home Sensor (with sensor to be re-detected) (No.645.0=2, No.645.3=1)

This operation indicates the type of homing based on the home position sensor.
another detection of the sensor-front-end after the first detection

You can use this homing type to set the point of machine passing the sensor as the home base. Re-detection of the sensor improves the accuracy in setting the home position.

There are three options to define "home" (after detection of passing-sensor position): 1) sensor position, 2) encoder z-phase, 3) any position shifted from sensor or z-phase.

Set the following parameters related to this homing method.

| Group | Name | Parameter No. |
|------------------|---|---------------|
| Homing Overall | Home reference signal selection (arbitrary position, stopper, sensor) | 645.0 (*) |
| | Movement direction | 646.0 |
| | Acceleration/Deceleration time (Common in Rough approach speed and Careful approach speed) | 650.0 |
| | Home position data | 653.0 |
| Rough approach | Sensor sensor polarity | 646.1 |
| | Rough approach speed | 648.0 |
| Careful approach | Careful approach switch | 647.1 (*) |
| | Encoder Z-phase Selection | 645.1 (*) |
| | Z-phase disabled distance | 657.0 (*) |
| | Re-detection of Home position | 645.3 (*) |
| | Sensor careful approach speed | 649.0 |
| Common | Amount of position shift to home (travel distance from base signal or z-phase to home) | 651.0 |
| | Internal Position: Motion of Point No.0 | 646.3 |
| | Homing: Torque command limit | 647.0 |
| | Homing: Timeout Switch | 646.2 |
| | Homing: Timeout Time | 659.0 |

*) Parameters to define the homing patterns

Refer to the patterns 19 to 24 to configure the parameters.

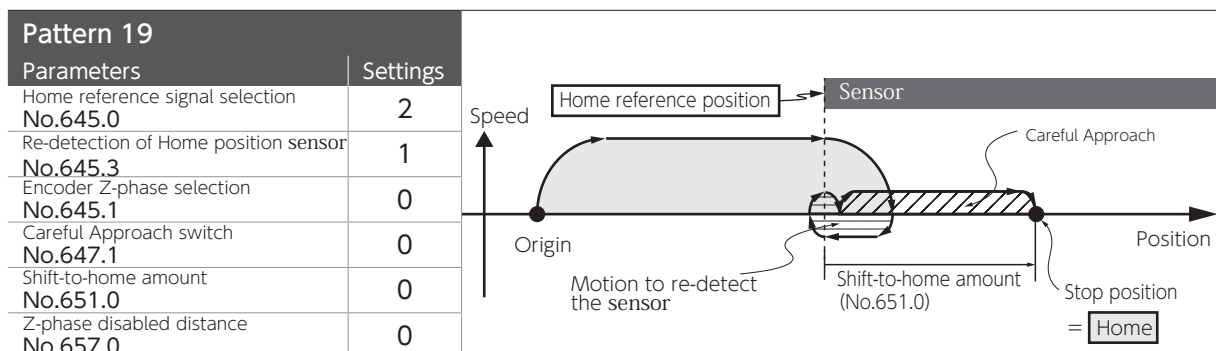

5. Position Control Mode

| Pattern 20 | |
|--|----------|
| Parameters | Settings |
| Home reference signal selection No.645.0 | 2 |
| Re-detection of Home position sensor No.645.3 | 1 |
| Encoder Z-phase selection No.645.1 | 0 |
| Careful Approach switch No.647.1 | 1 |
| Shift-to-home amount No.651.0 | (any) |
| Z-phase disabled distance No.657.0 | 0 |

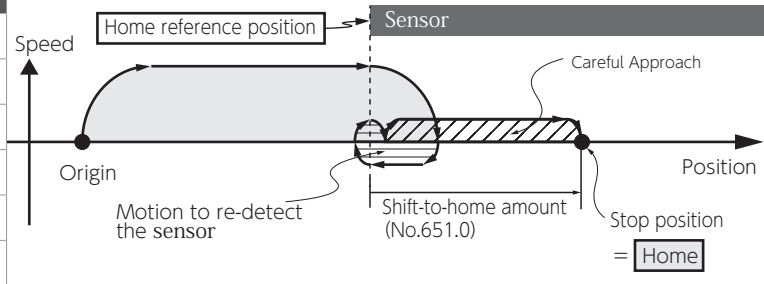

| Pattern 21 | |
|--|----------|
| Parameters | Settings |
| Home reference signal selection No.645.0 | 2 |
| Re-detection of Home position sensor No.645.3 | 1 |
| Encoder Z-phase selection No.645.1 | 1 |
| Careful Approach switch No.647.1 | 1 |
| Shift-to-home amount No.651.0 | 0 |
| Z-phase disabled distance No.657.0 | 0 |

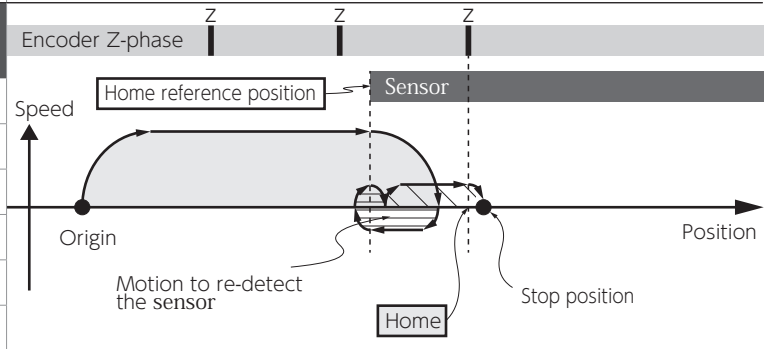

| Pattern 22 | |
|--|----------|
| Parameters | Settings |
| Home reference signal selection No.645.0 | 2 |
| Re-detection of Home position sensor No.645.3 | 1 |
| Encoder Z-phase selection No.645.1 | 1 |
| Careful Approach switch No.647.1 | 1 |
| Shift-to-home amount No.651.0 | (any) |
| Z-phase disabled distance No.657.0 | 0 |

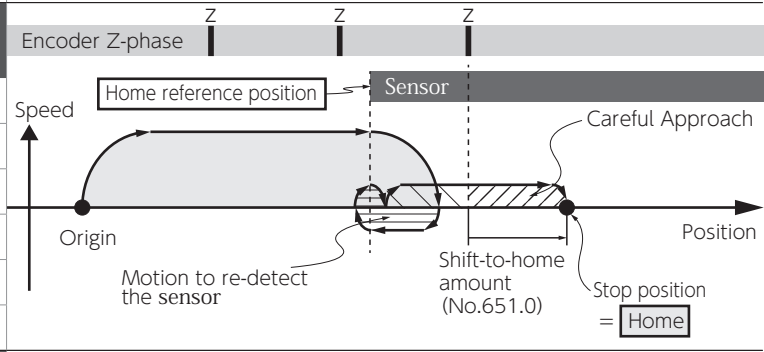

| Pattern 23 | |
|--|----------|
| Parameters | Settings |
| Home reference signal selection No.645.0 | 2 |
| Re-detection of Home position sensor No.645.3 | 1 |
| Encoder Z-phase selection No.645.1 | 1 |
| Careful Approach switch No.647.1 | 1 |
| Shift-to-home amount No.651.0 | 0 |
| Z-phase disabled distance No.657.0 | (any) |

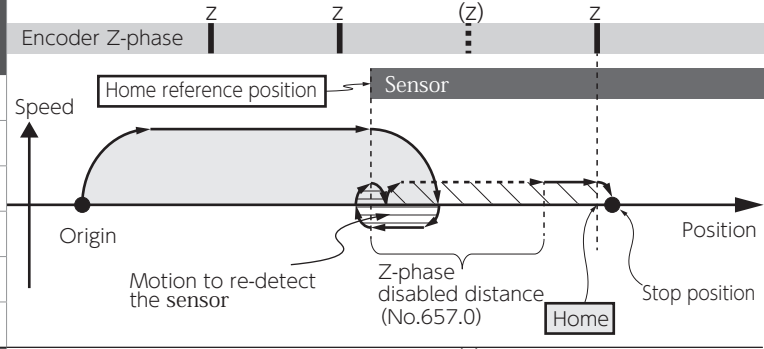

| Pattern 24 | |
|--|----------|
| Parameters | Settings |
| Home reference signal selection No.645.0 | 2 |
| Re-detection of Home position sensor No.645.3 | 1 |
| Encoder Z-phase selection No.645.1 | 1 |
| Careful Approach switch No.647.1 | 1 |
| Shift-to-home amount No.651.0 | (any) |
| Z-phase disabled distance No.657.0 | (any) |

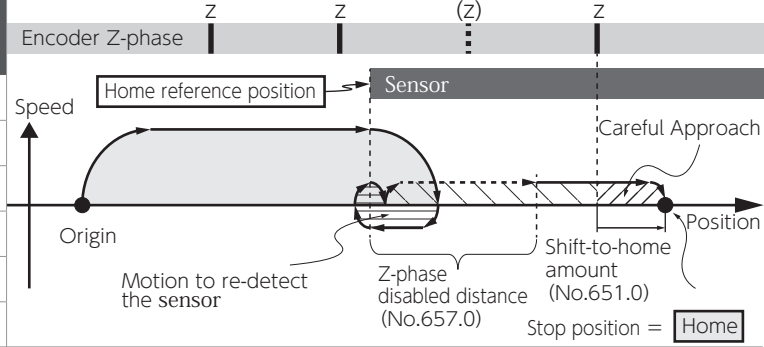

| | |
|---|----|
| 1. Introduction | 2 |
| 1. Overview | 2 |
| 2. Control Block Diagram | 4 |
| 2. Tuning Procedure | 7 |
| 1. Overview | 8 |
| 2. Position Control Mode | 9 |
| Quick Tuning on Digitax SF Connect. | 9 |
| Final Tuning: Position Control Mode | 12 |
| Quick Tuning on Setup Panel. | 14 |
| 3. Velocity Control Mode | 17 |
| Auto Tuning on Digitax SF Connect | 17 |
| Final Tuning: Velocity Control Mode | 20 |
| Auto Tuning on Setup Panel. | 22 |
| 3. Tuning Parameters | 26 |
| 1. Tuning | 26 |
| Inertia Condition | 26 |
| Control Gain Set | 27 |
| Mode Switch | 28 |
| Tuning Items | 28 |
| 2. Final Tuning. | 29 |
| Inertia Ratio | 29 |
| Position Control Mode: Control Gain 1. | 30 |
| Position Control Mode: Control Gain 2. | 31 |
| Velocity Control Mode: Control Gain 1 | 32 |
| Position Control Mode: Gain FF Compensation 1 | 33 |
| Position Control Mode: Gain FF Compensation 2 | 34 |
| Integral Gain | 35 |
| 3. Position Command Filter | 36 |
| Position Command Smoothing Filters 1 and 2. | 38 |
| Position Command Notch Filter. | 39 |
| Position Command γ -Notch Filter. | 40 |
| 4. Torque Command Filter | 41 |
| Torque Command Filter: Notch Filter | 42 |
| Torque Command Low-Pass Filter. | 43 |
| 4. Using Digitax SF Connect to Measure Vibration Frequency (FFT). | 44 |

1. Introduction

1. Overview

The goal of drive tuning is having good control over the motor and optimizing equipment performance in responding to commands from the host controller.
 The position control method employs two degrees of freedom with the model-matching control. This method enables you to adjust command response and transient response independently without compromising the stability of your equipment.
 Digitax SF is a servo system that does not let overshooting and undershooting happen when the equipment inertia ratio is set appropriately.
 Digitax SF features response models with two cutoff frequencies: $\omega 1$ (Control Gain 1) and $\omega 2$ (Control Gain 2)

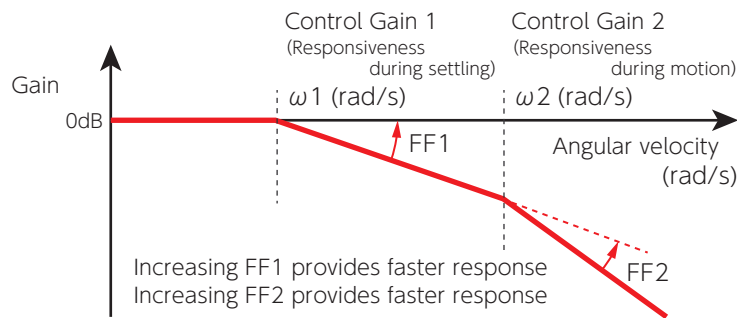

Response model for position control and two cutoff frequencies

| Code | EFFECT |
|------------------------------|---|
| $\omega 1$ Control Gain 1 | Responsiveness at settling Increasing this item will reduce the position error at settling (after command ends). |
| $\omega 2$ Control Gain 2 | Responsiveness during operation Increasing this item will reduce the position error during operation (while command being input). |
| FF1 FF Compensation 1 | Command compensation for $\omega 1$ Increasing this item will improve the $\omega 1$ response. |
| FF2 FF Compensation 2 | Command compensation for $\omega 2$ Increasing this item will improve the $\omega 2$ response. |

The relation between cutoff frequencies and control gain parameters.



- Position loop gain (*1) : $\frac{\omega 1 \omega 2}{\omega 1 + \omega 2}$
- Velocity loop gain (*2) : $\omega 1 + \omega 2$

*1) Position loop gain It is equivalent to the "Kp" in a P-PI control.
 *2) Velocity loop gain It is equivalent to the "Kv" in a P-PI control.

Control Gain Set

The following prearranged sets of parameters for each control mode enable you to perform tuning easily. (*)

*) If the [Torque command filter: Low-pass filter auto setting (160.2)] is set to 1(auto setting ON), "Torque command filter: Low-pass filter" will be included in the gain set.

| Control Mode | Parameter Set |
|--|---|
| Position Control Mode  | Control Gain 1, Control Gain 2, Integral Gain |
| Velocity Control Mode  | Control Gain 1, Integral Gain |

Inertia Condition

Digitax SF features three response models to support a variety of equipment. Three models are different in ratios of Control Gain 1 ($\omega 1$) and Control Gain 2 ($\omega 2$) and you can select the one suitable to the stability and convergence of your equipment.

Inertia Condition

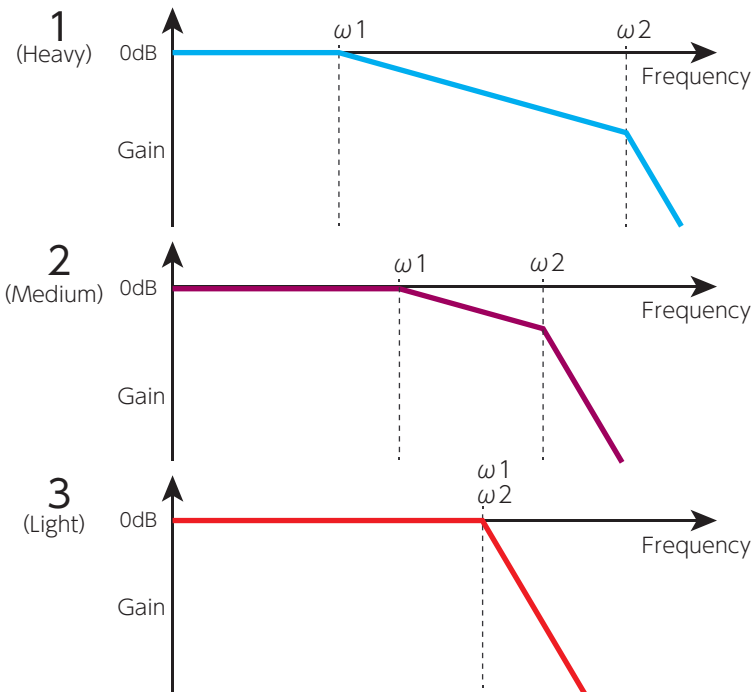

Equipment Example

Higher stability
 Good for applications of large load fluctuation
 • Robot

Higher convergence
 Micro vibration/ disturbance-resistant
 • Automatic machines
 • Surface mounters



Velocity Control Mode

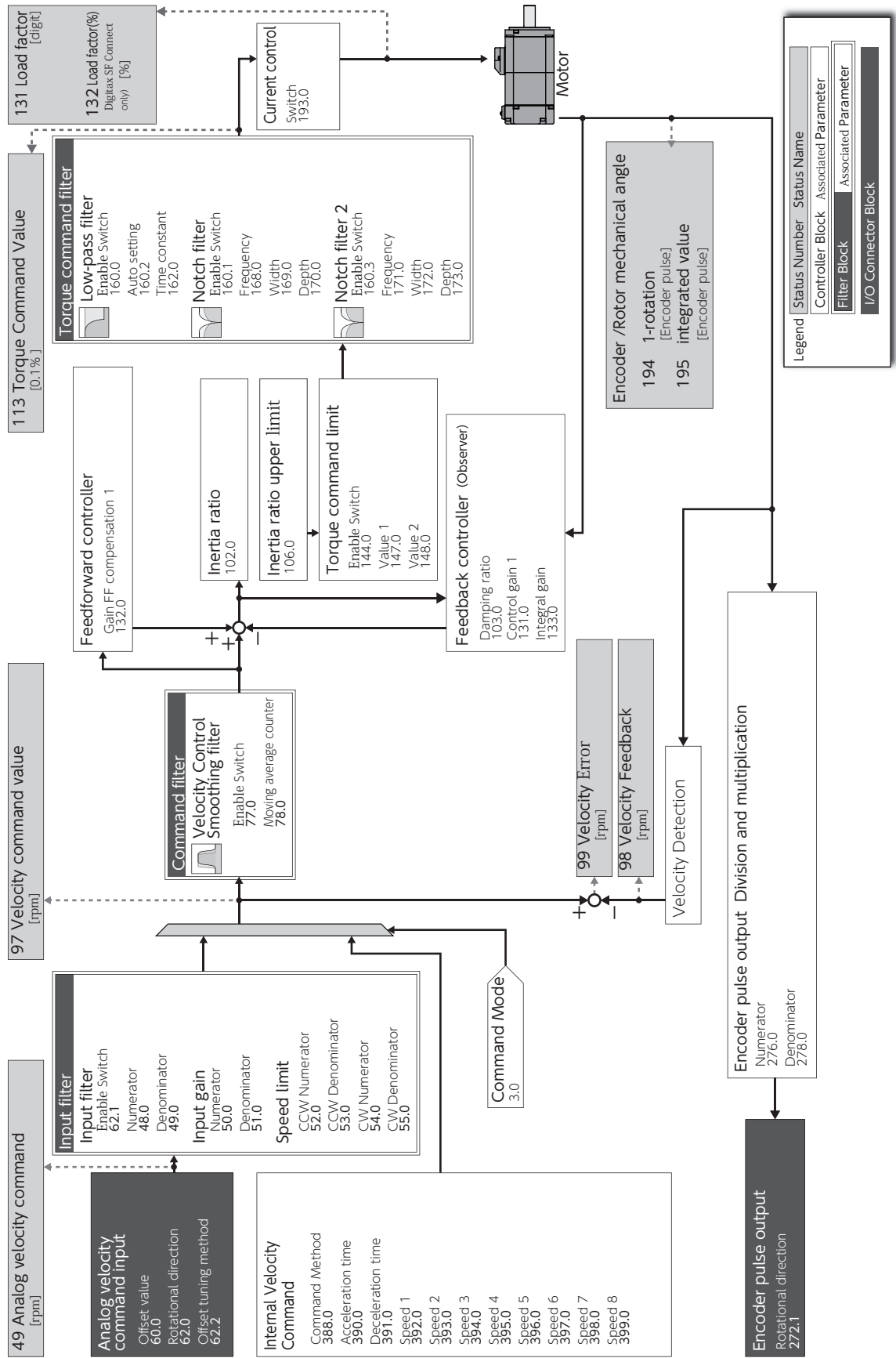





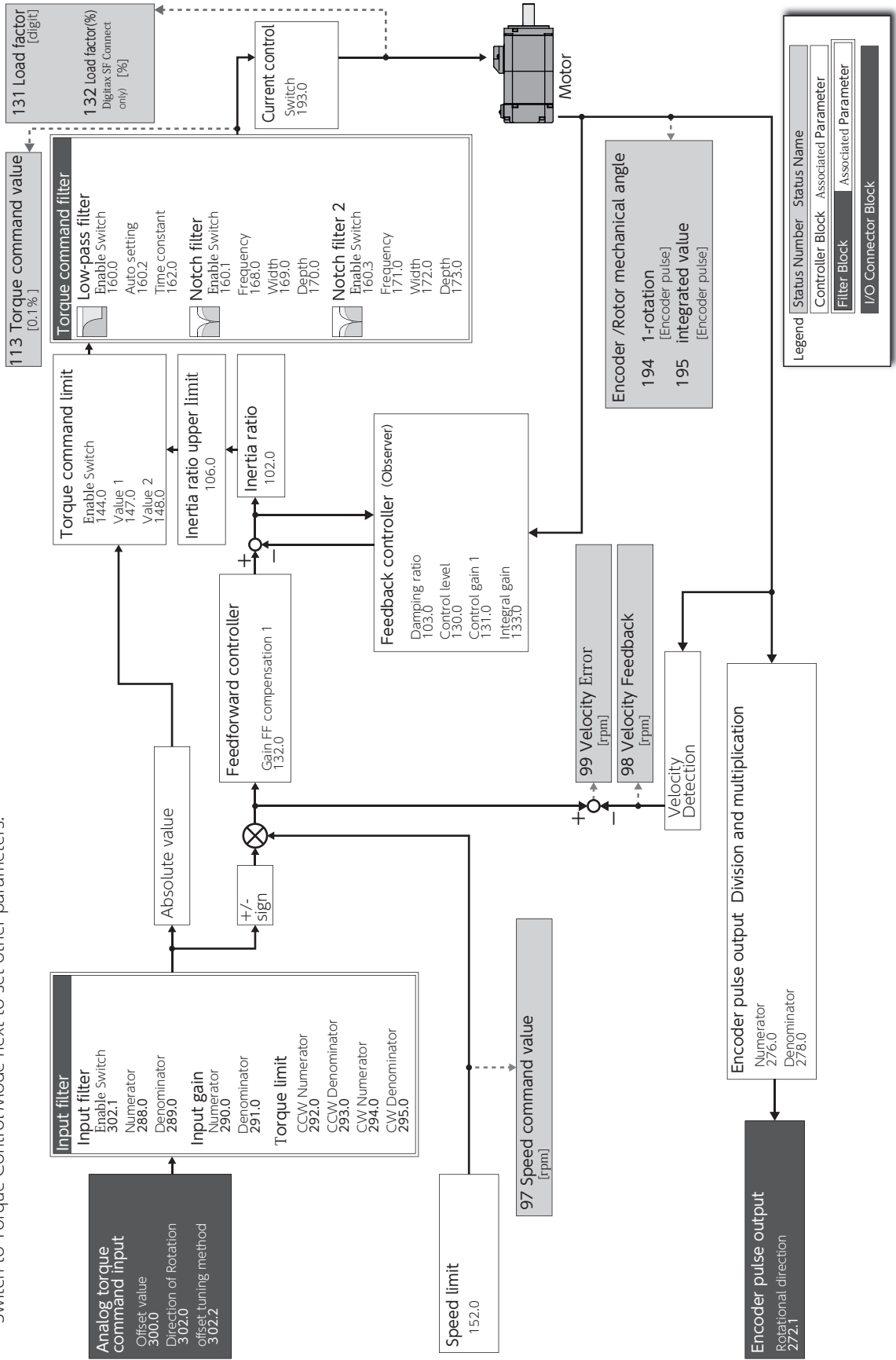

Torque Control Mode



Set the tuning parameters in Speed Control Mode first. Switch to Torque Control Mode next to set other parameters.



2. Tuning Procedure

| | | |
|---|---|---|
|  | Before getting started with tuning, be sure to implement safety measures such as hazard prevention, quick stop and impact mitigation measures. |  |
|  | When operating the servo motor for tuning, start with acceleration/ deceleration speeds slower than your target speed. Ensure safety first, then gradually increase the speed and perform tuning each time. | |
|  | While tuning with Digitax SF Connect, do not use the Setup Panel. | |
|  | While tuning with the Setup Panel, do not operate the motor with Digitax SF Connect. | |

For optimal performance of drive functions and features, the parameters to the drive need to be configured. Wrong parameter settings will cause unexpected behaviours or difficulties in controlling the motor. Please read the instruction manuals very carefully to figure out the settings that will best suit your operational conditions

| Step | Operation |
|------|--|
| 1 | Verify that all wiring has been performed properly. |
| 2 | Turn on the control power to the drive. |
| 3 | Turn on the AC supply to the drive. |
| 4 | To turn the servo ON, connect the SVON pin on the CN1 connector to COM-. |
| 5 | Operate the motor at lower speeds according to the command pulse from the host controller. |
| | Start tuning with one of the following methods. |
| 6 |  Use the setup support software Digitax SF Connect. Install it on a user-supplied computer. |
| |  Use the Setup Panel at the front of the drive. |

Any of the following may interrupt proper performance of Quick Tuning or Auto Tuning.

The inertia ratio is less than 3 or above 20. (*1)

The load inertia is fluctuating.

Machine rigidity is extremely low.

Non-linear characteristics such as backlash exist.

The speed is low (800 rpm or lower). (*2)

The acceleration or deceleration speed is moderate (around 2,000 rpm/s).

The torque is extremely large or small.

In those situations, set the inertia ratio manually based on calculated values.

*1) When a too big load inertia is connected, the estimated inertia ratio value will be restricted by the upper limit value determined by the upper limit value of the inertia ratio (106.0).

*2) Proper tuning may not be possible in the case of 300 rpm or below.

1. Overview

Position Control Mode



| | |
|--|---|
| <p>Stage 1</p> <p>Quick Tuning</p> | <p>Setting the Inertia ratio and Optimizing Control Gain Set</p> <p>The inertia ratio value is entered by the user if known or can be estimated as part of auto-tuning. The control gain set will be automatically adjusted according to the auto estimate of inertia ratio.</p> <p>This method does not generate noise caused by any conflict between the inertia ratio and the gain set.</p> <p> Page 9 Quick Tuning on Digitax SF Connect</p> <p> Page 14 Quick Tuning on Setup Panel</p> |
| <p>Stage 2</p> <p>Final Tuning</p> <p>Performed by Digitax SF Connect)</p> | <p>Optimizing the settling time and error</p> <p>Suppressing vibration and noise</p> <p>After Quick Tuning was performed, you might need further adjustments for some of the parameters individually.</p> <p>Final Tuning will improve responsiveness, settling time, and degree of freedom to achieve optimal performance of equipment.</p> <p> Page 12 Final Tuning: position control mode</p> |

Velocity Control Mode



| | |
|---|---|
| <p>Stage 1</p> <p>Auto Tuning</p> | <p>Setting the Inertia ratio and Optimizing Control Gain Set</p> <p>The inertia ratio value is entered by the user if known or can be estimated as part of auto-tuning.</p> <p>You can select one of the control gain sets according to your equipment. Auto estimated inertia ratio will be applied.</p> <p> Page 17 Auto Tuning on Digitax SF Connect</p> <p> Page 22 Auto Tuning on Setup Panel</p> |
| <p>Stage 2</p> <p>Final Tuning</p> <p>Performed by Digitax SF Connect</p> | <p>Optimizing the settling time and error</p> <p>Suppressing vibration and noise</p> <p>After Auto Tuning was performed, you might need further adjustments for some of the parameters individually.</p> <p>Final Tuning will improve responsiveness, settling time, and degree of freedom to achieve optimal performance of equipment.</p> <p> Page 20 Final Tuning: Velocity control mode</p> |

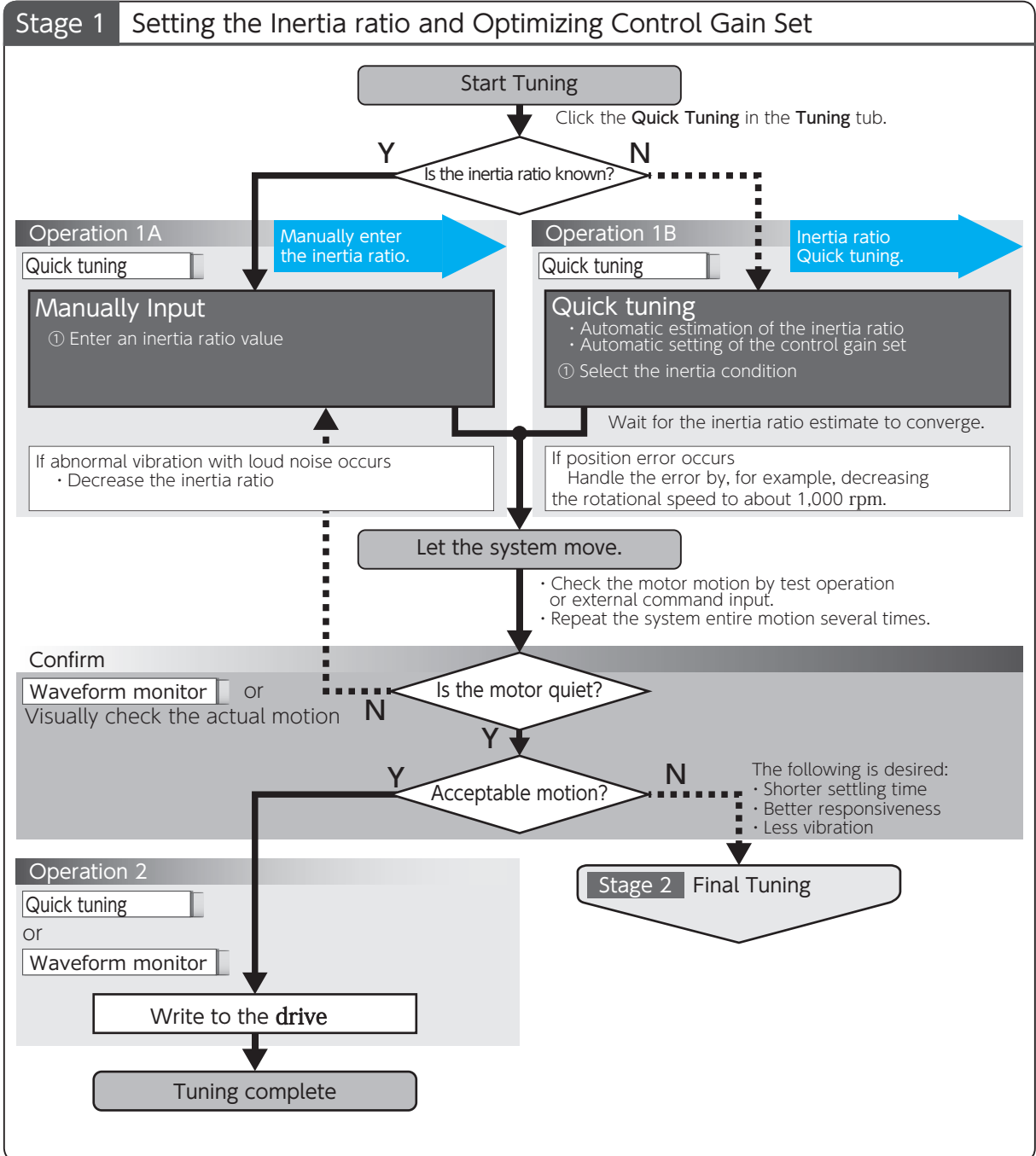

2. Tuning Procedure

Quick Tuning on Digitax SF Connect: Operation 1A

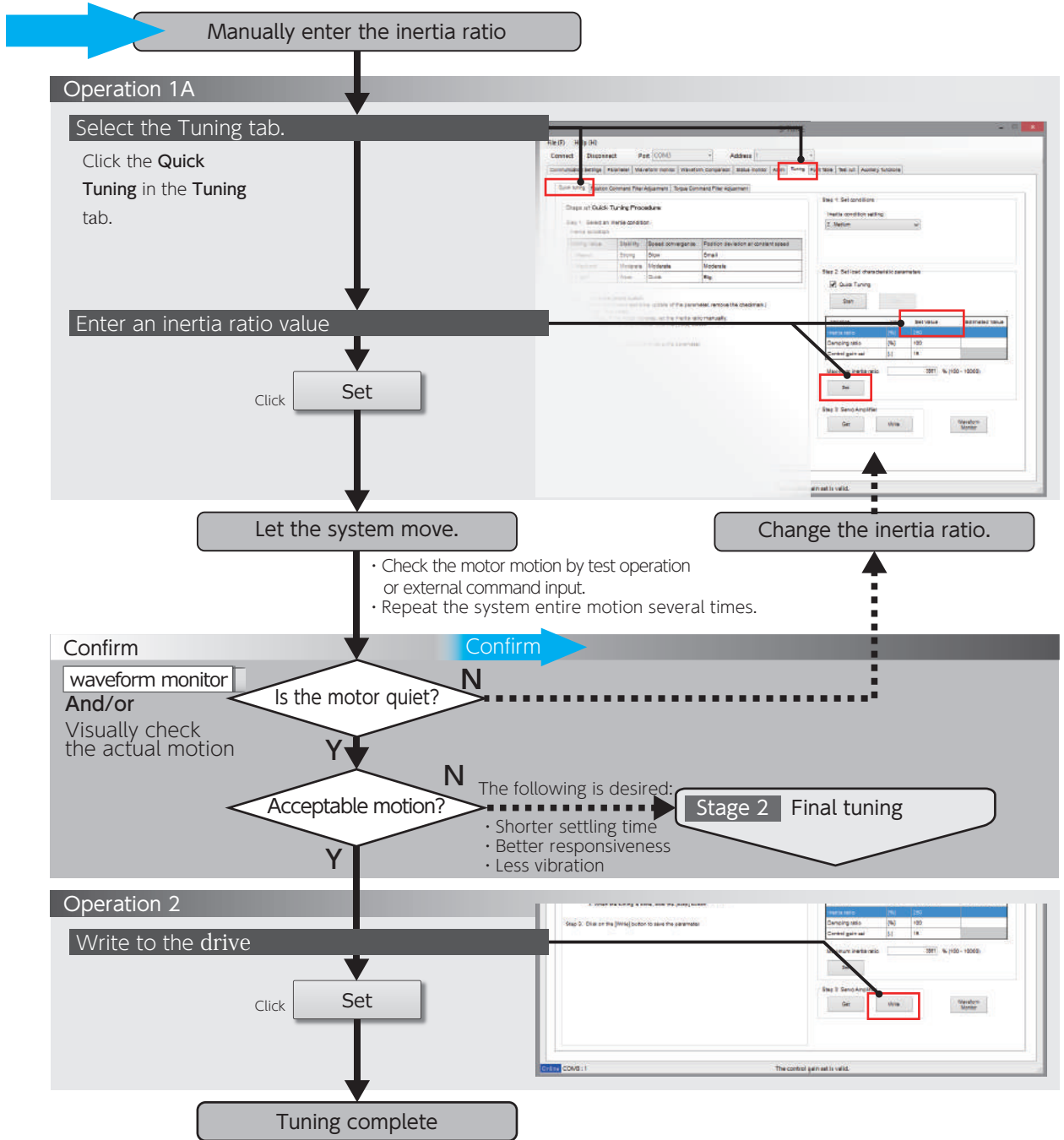

2. Tuning Procedure

Quick Tuning on Digitax SF Connect: Operation 1B

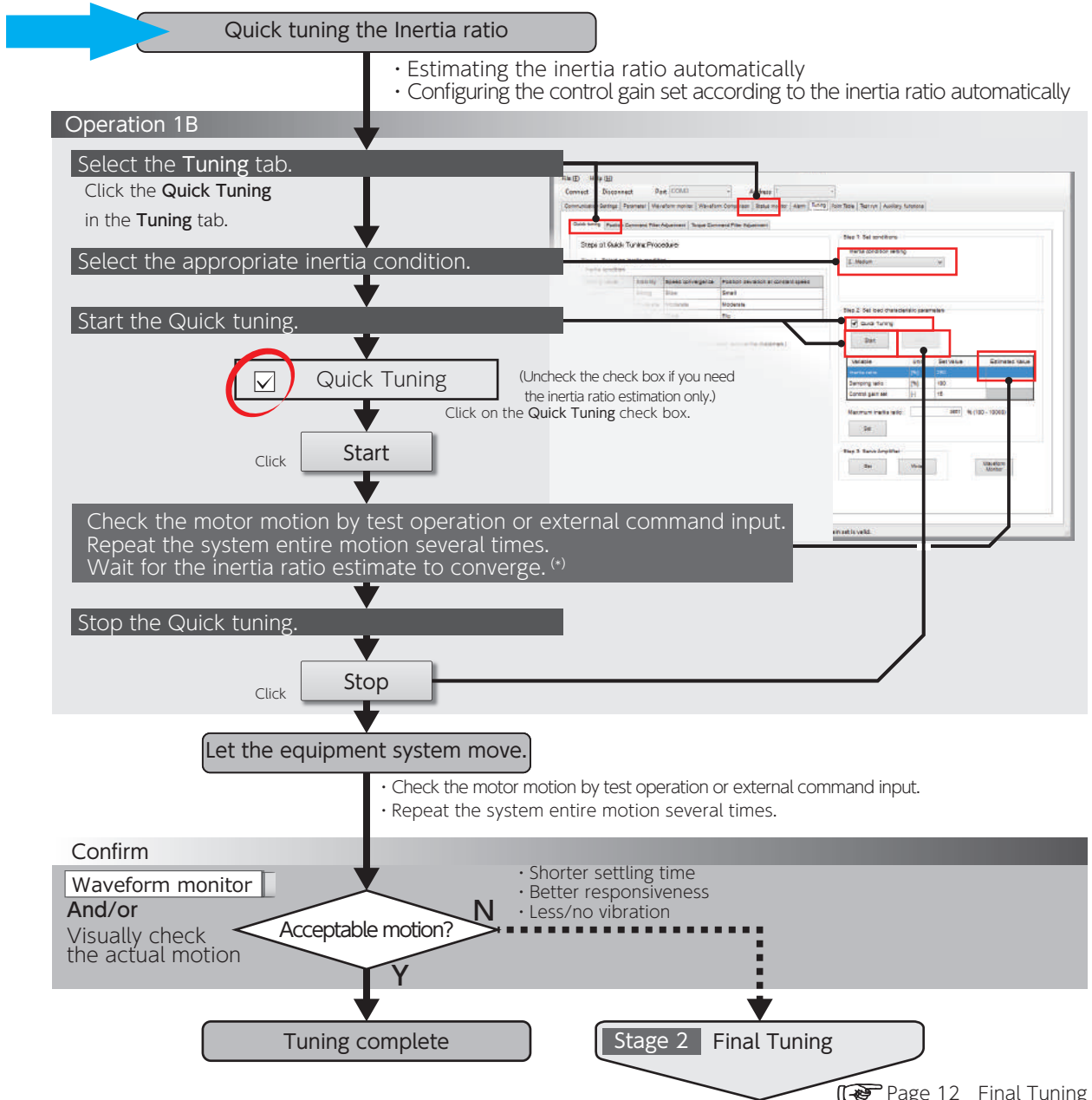

*) Extremely large load may cause vibration. In such a case, decrease the parameter setting of Tuning: Control gain set - Tuning constant (121.0).



Make sure to click on [Stop] to finish Quick Tuning.

Starting Final Tuning Mode while Quick Tuning is still in process will make the tuning difficult because of inertia ratio changes.

Final Tuning: Position Control Mode

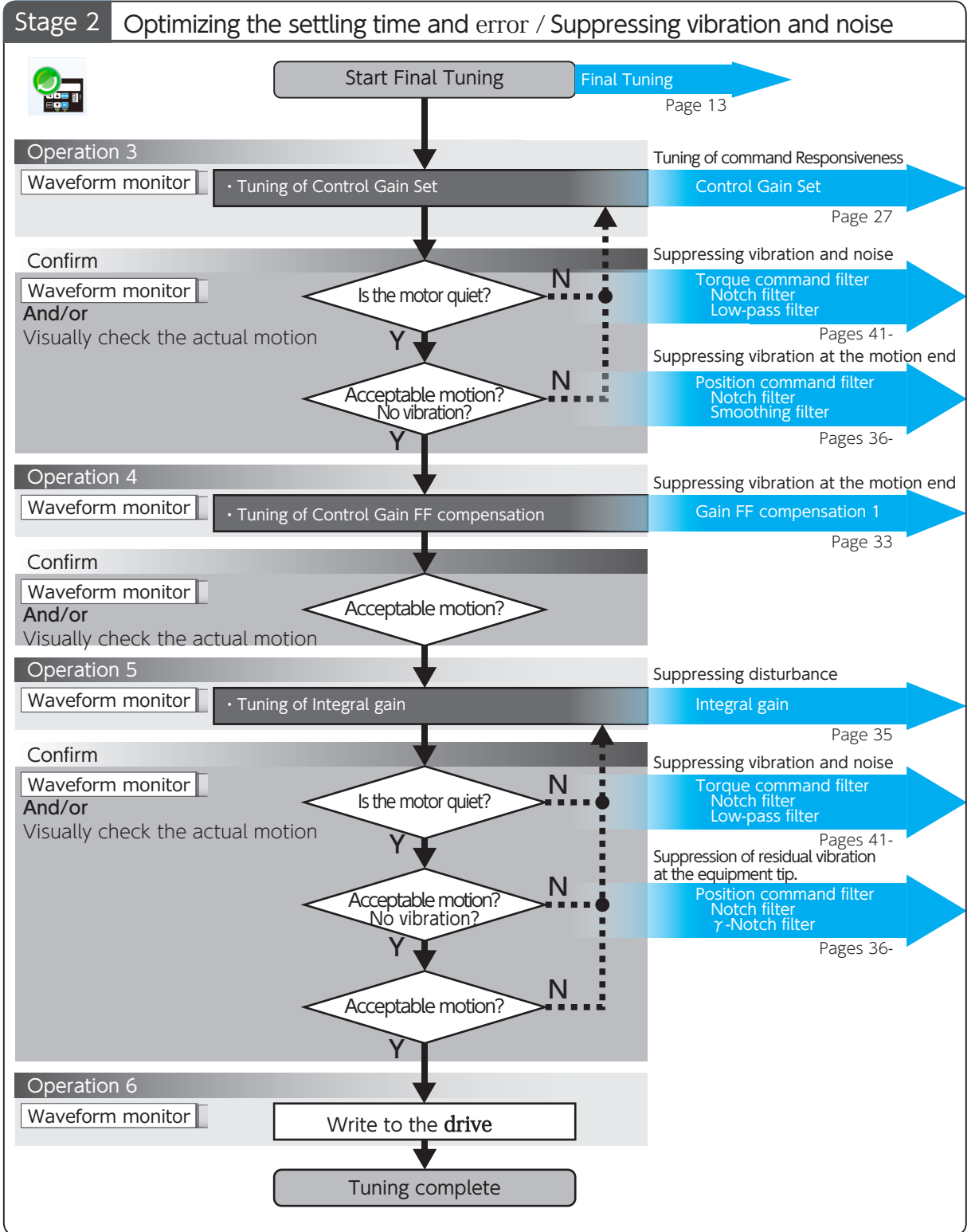



Final Tuning

Start Final Tuning

Operation 3, 4, and 5

Change Control Gain Set

Click Set

Let the equipment system move. (*)

Change Gain FF Compensation

Click Set

Let the equipment system move. (*)

Change Integral Gain

Click Set

Let the equipment system move. (*)

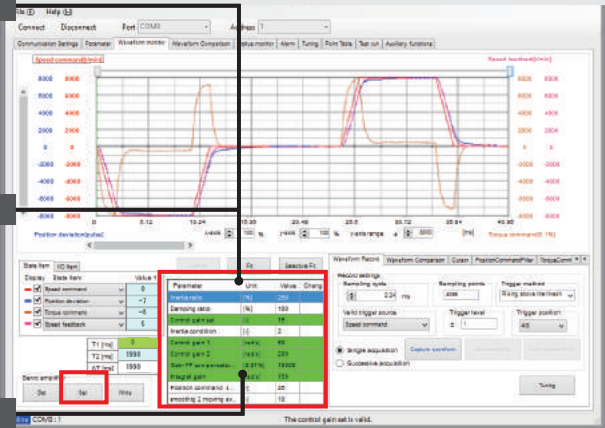

*) • Check the motor motion by test operation or external command input.
• Repeat the system entire motion several times.

Confirm

Waveform monitor
And/or
Visually check the motion etc.

Acceptable motion?

Confirm

Torque command filter
Position command filter

Pages 41-
Pages 36-

Operation 6

Write to the drive

Click Write

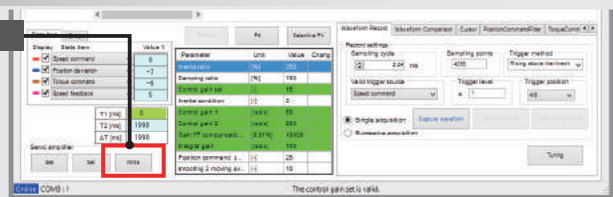

Tuning complete

Quick Tuning on Setup Panel

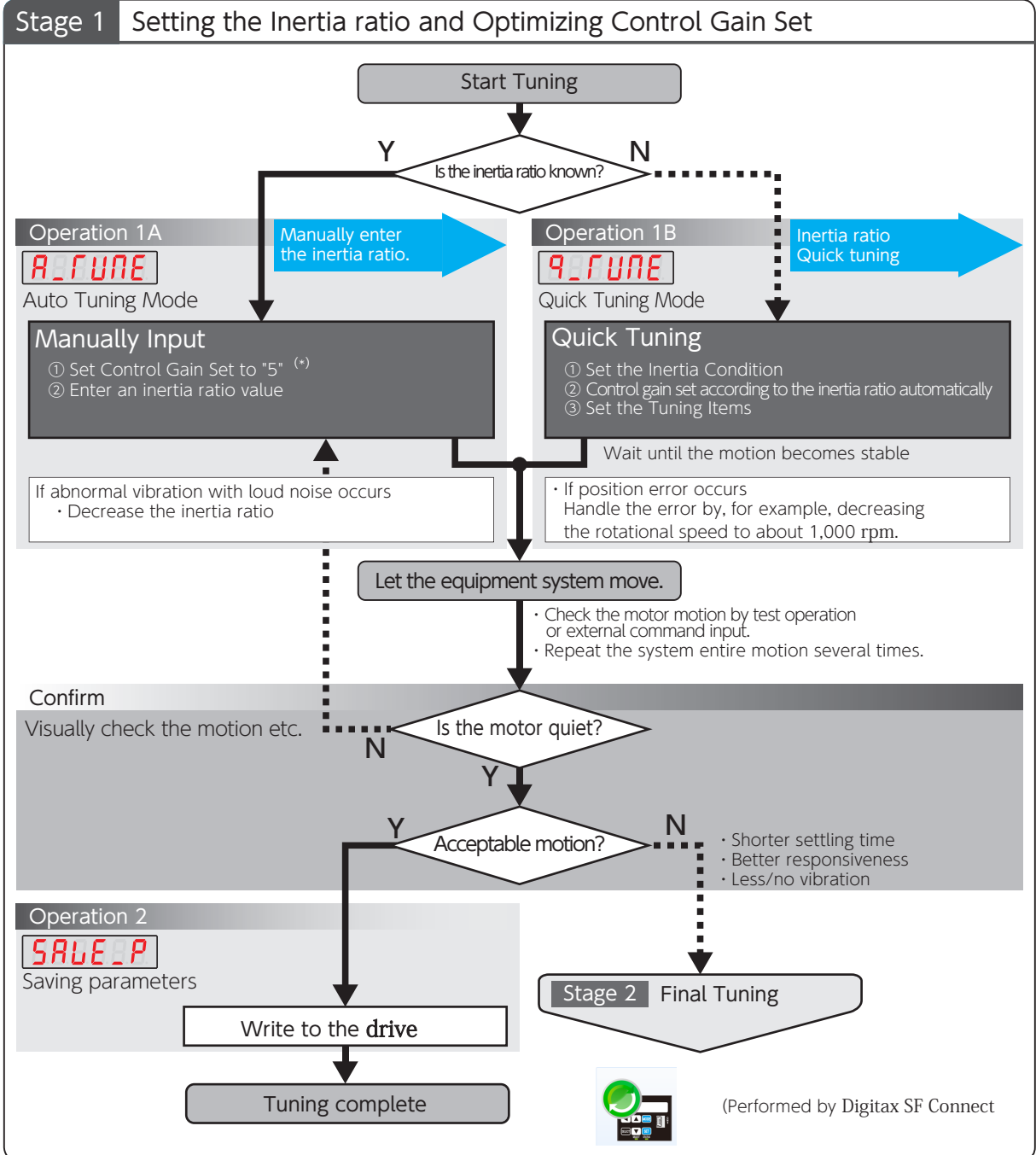

*) Starting tuning with a low setting of the controller gain set will enable successful tuning with no vibrations and low noise.

2. Tuning Procedure

Quick Tuning on Setup Panel: Operation 1A

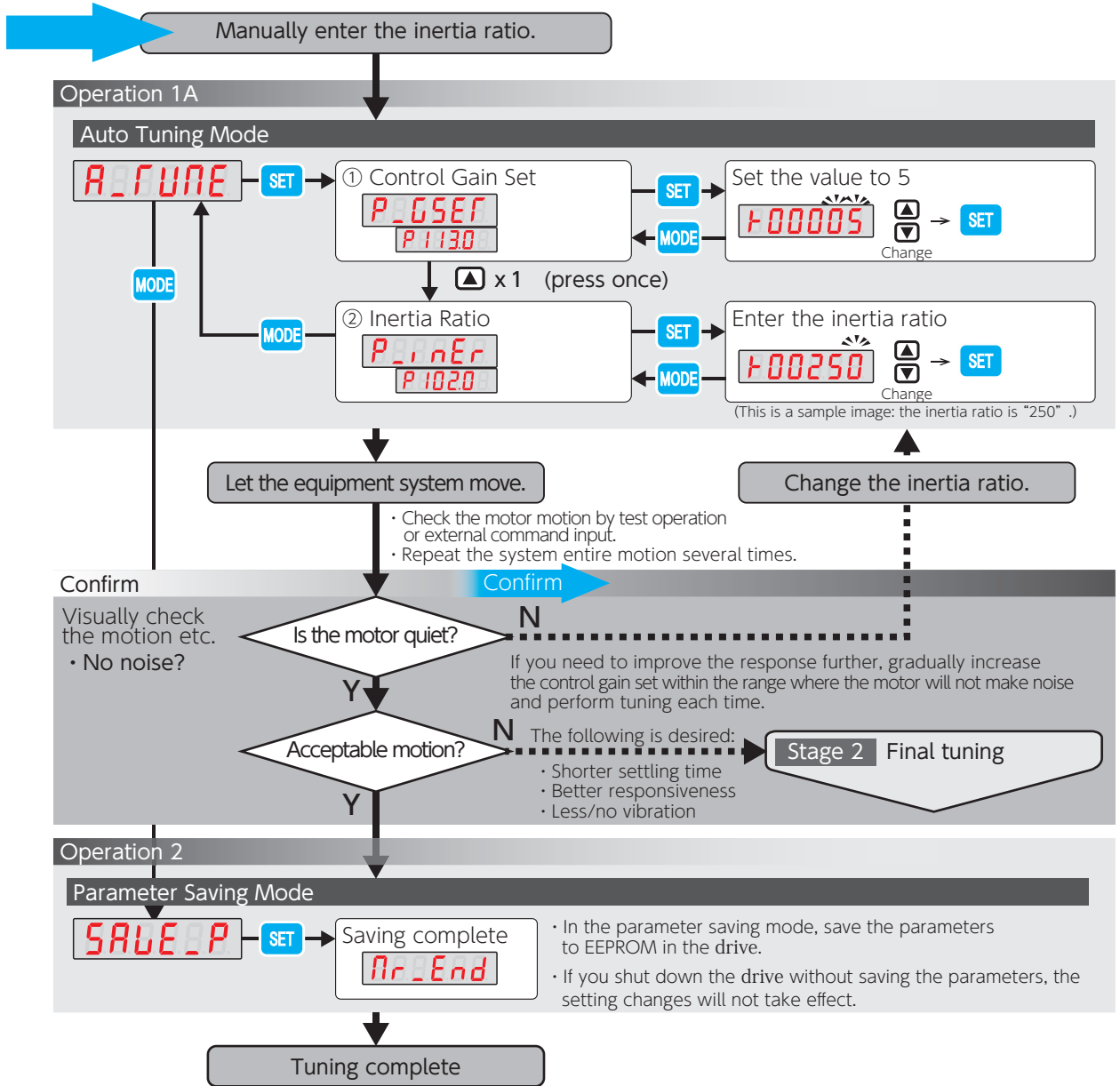

2. Tuning Procedure



Quick Tuning on Setup Panel: Operation 1B

Inertia ratio estimation by the quick tuning

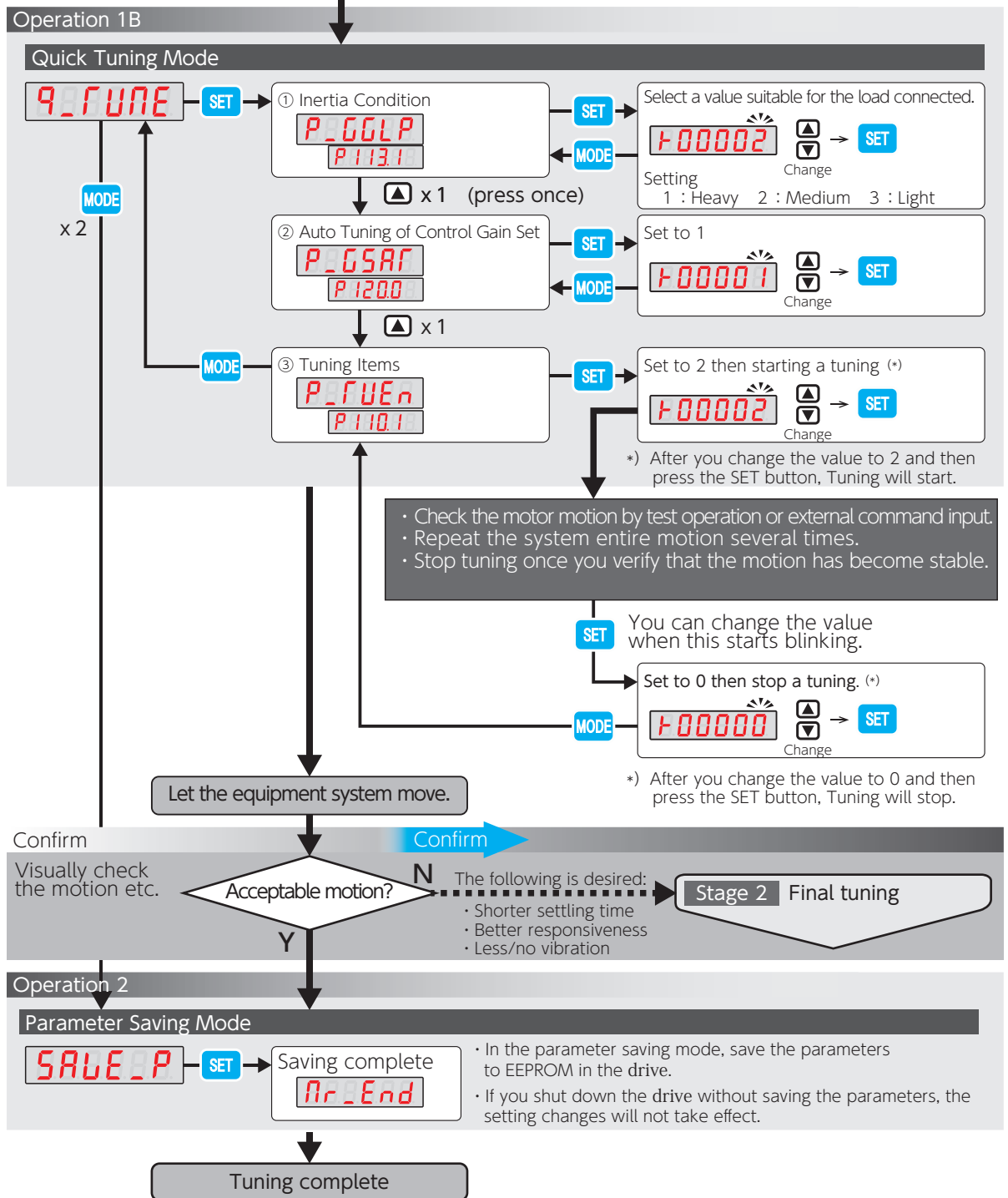

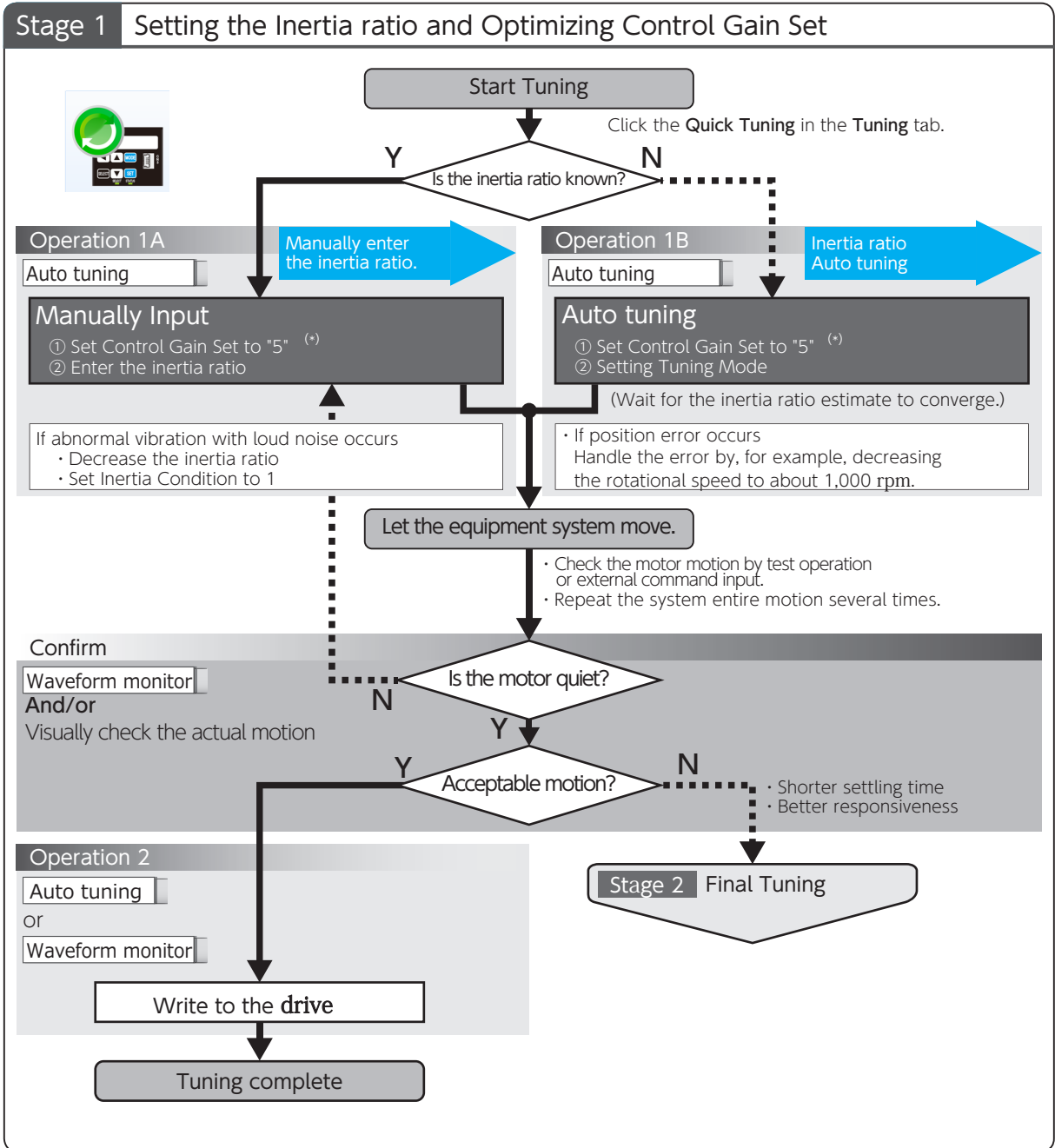

*) Starting tuning with a low setting of the controller gain set will enable successful tuning with no vibrations low noise

2. Tuning Procedure



Auto Tuning on Digitax SF Connect: Operation 1A

Manually enter the inertia ratio.

Operation 1A

Select the Tuning tab.

Set Control Gain Set to "5"

Starting tuning with a low setting of the controller gain set will enable successful tuning with no vibrations and low noise.

Click **Set**

Enter the inertia ratio

Click **Set**

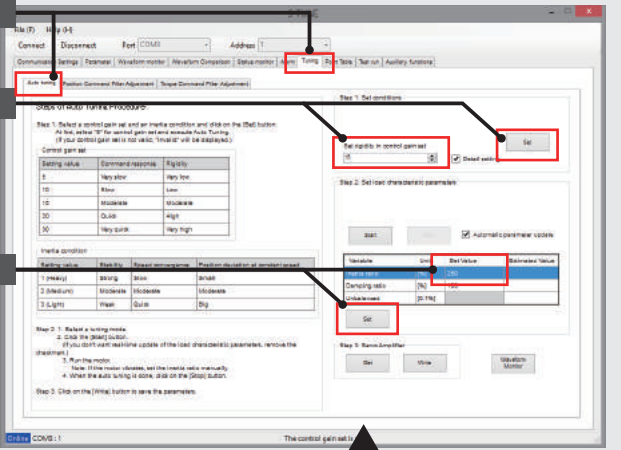

Let the equipment system move.

- Check the motor motion by test operation or external command input.
- Repeat the system entire motion several times.

Change the inertia ratio.

Confirm

Waveform monitor
And/or
Visually check the actual motion

Is the motor quiet?

Confirm

Acceptable motion?

Stage 2 Final tuning

Operation 2

Write to the drive

Click **Set**

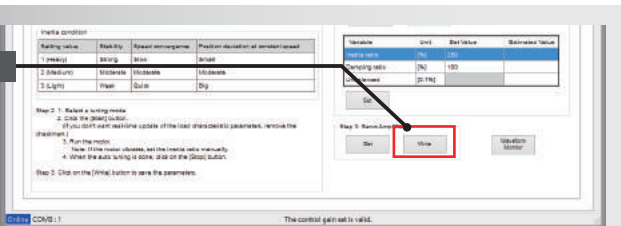

Tuning complete

2. Tuning Procedure

Auto Tuning on Digitax SF Connect: Operation 1B



Inertia ratio estimation by the auto tuning

Operation 1B

Select the Tuning tab

Set Control Gain Set to "5"

Starting tuning with a low setting of the controller gain set will enable successful tuning with no vibrations and low noise.

Click **Set**

Start the Auto tuning

Automatic parameter update

Click on the check box.

Click **Start**

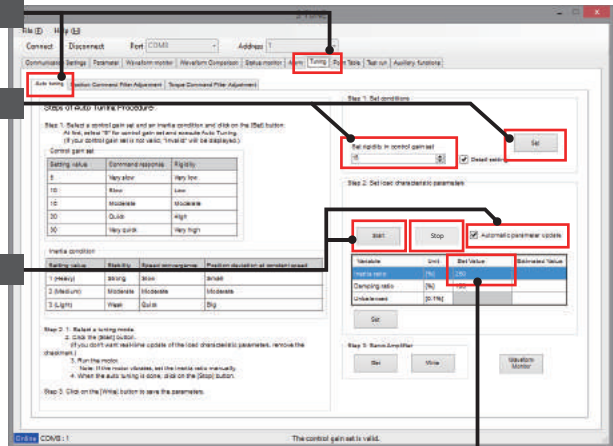

Check the motor motion by test operation or external command input. Repeat the system entire motion several times. Wait for the inertia ratio estimate to converge.

Stop the Auto tuning

Click **Stop**

Confirm

Waveform monitor
And/or
Visually check the actual motion

Is the motor quiet?

Confirm

Manually enter the inertia ratio.

Acceptable motion?

Shorter settling time
Better responsiveness

Stage 2 Final tuning

Operation 2

Write to the drive

Click **Set**

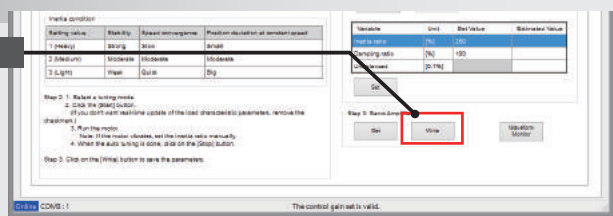

Tuning complete



Make sure to click on [Stop] to finish Auto Tuning.

Starting Final Tuning Mode while Auto Tuning is still in process will make the tuning difficult because of inertia ratio changes.

Final Tuning: Velocity Control Mode



Stage 2 Optimizing the settling time and error / Suppressing vibration and noise

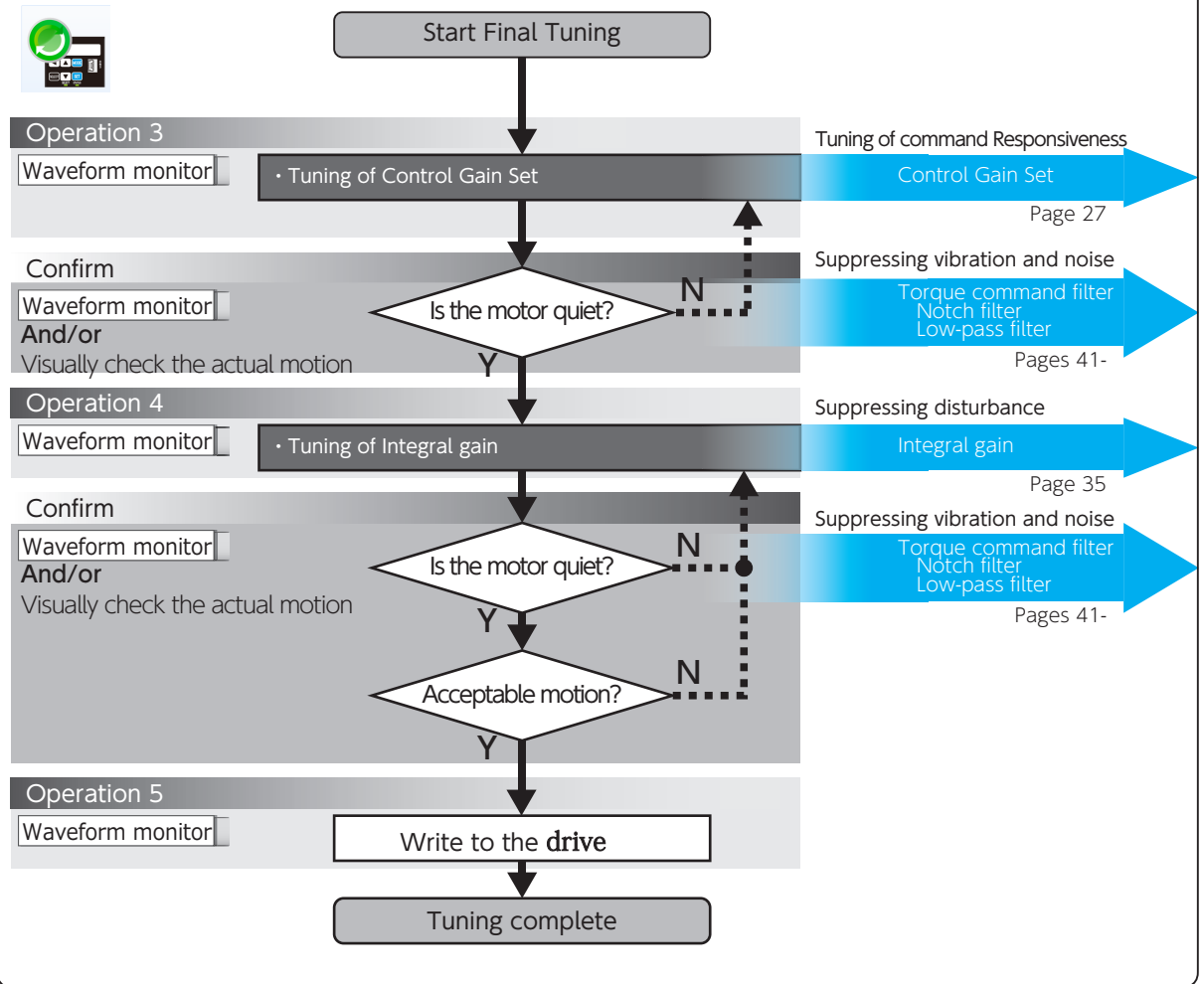

2. Tuning Procedure

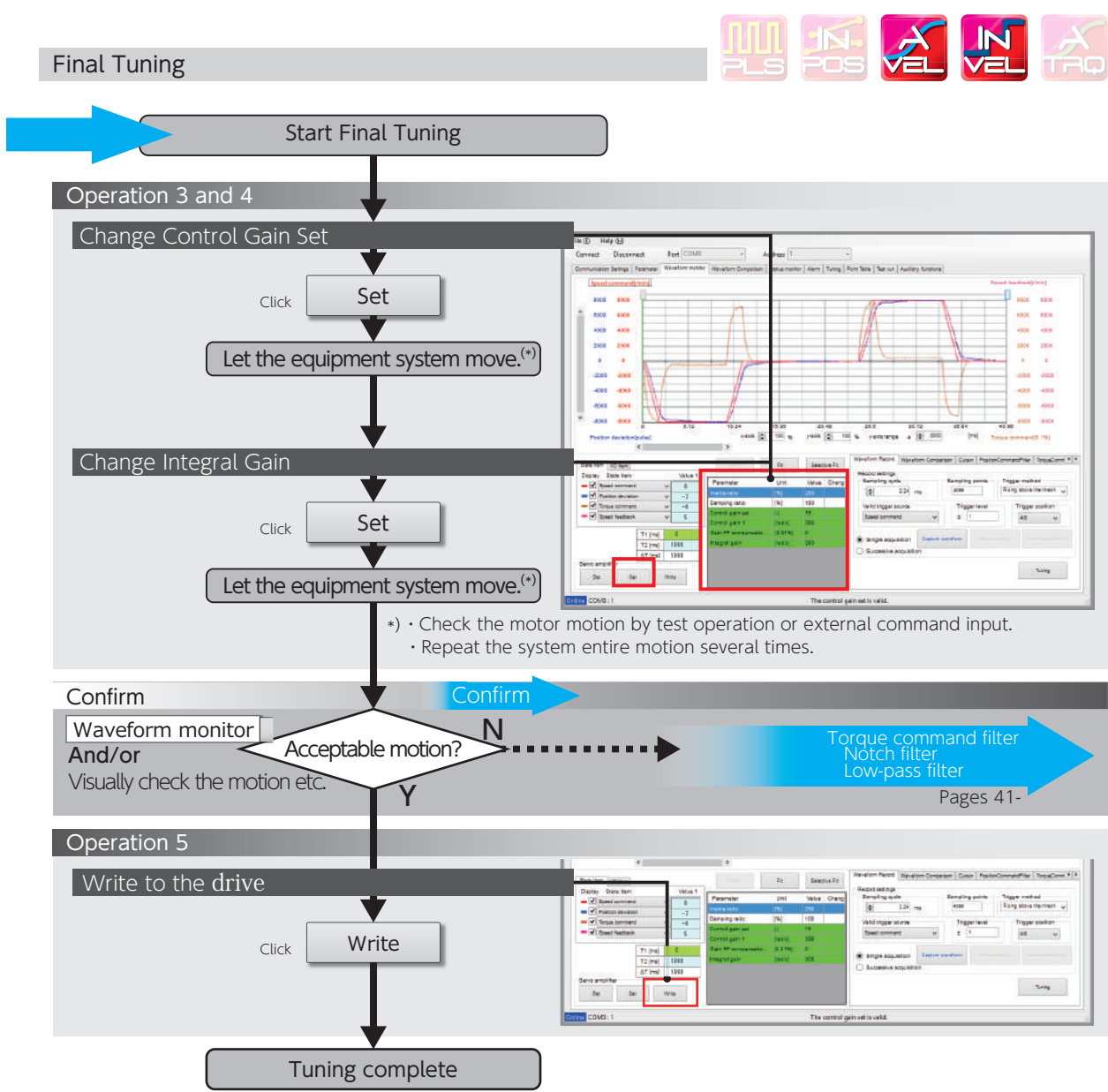

Auto Tuning on Setup Panel



Stage 1 Setting the Inertia ratio and Optimizing Control Gain Set

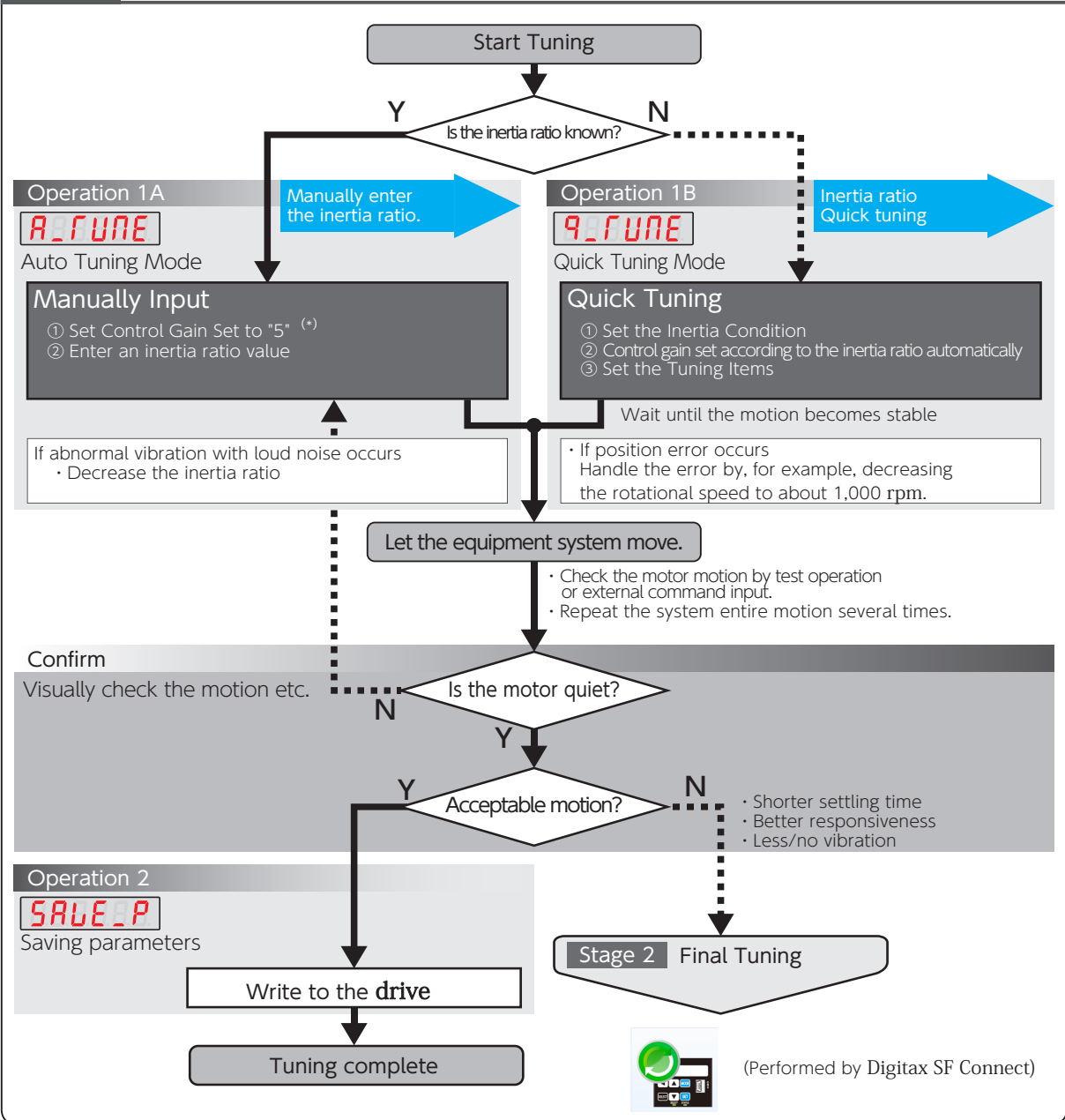

*) Starting tuning with the lowest setting of the controller gain set will provide successful tuning with no vibrations and low noise.

2. Tuning Procedure

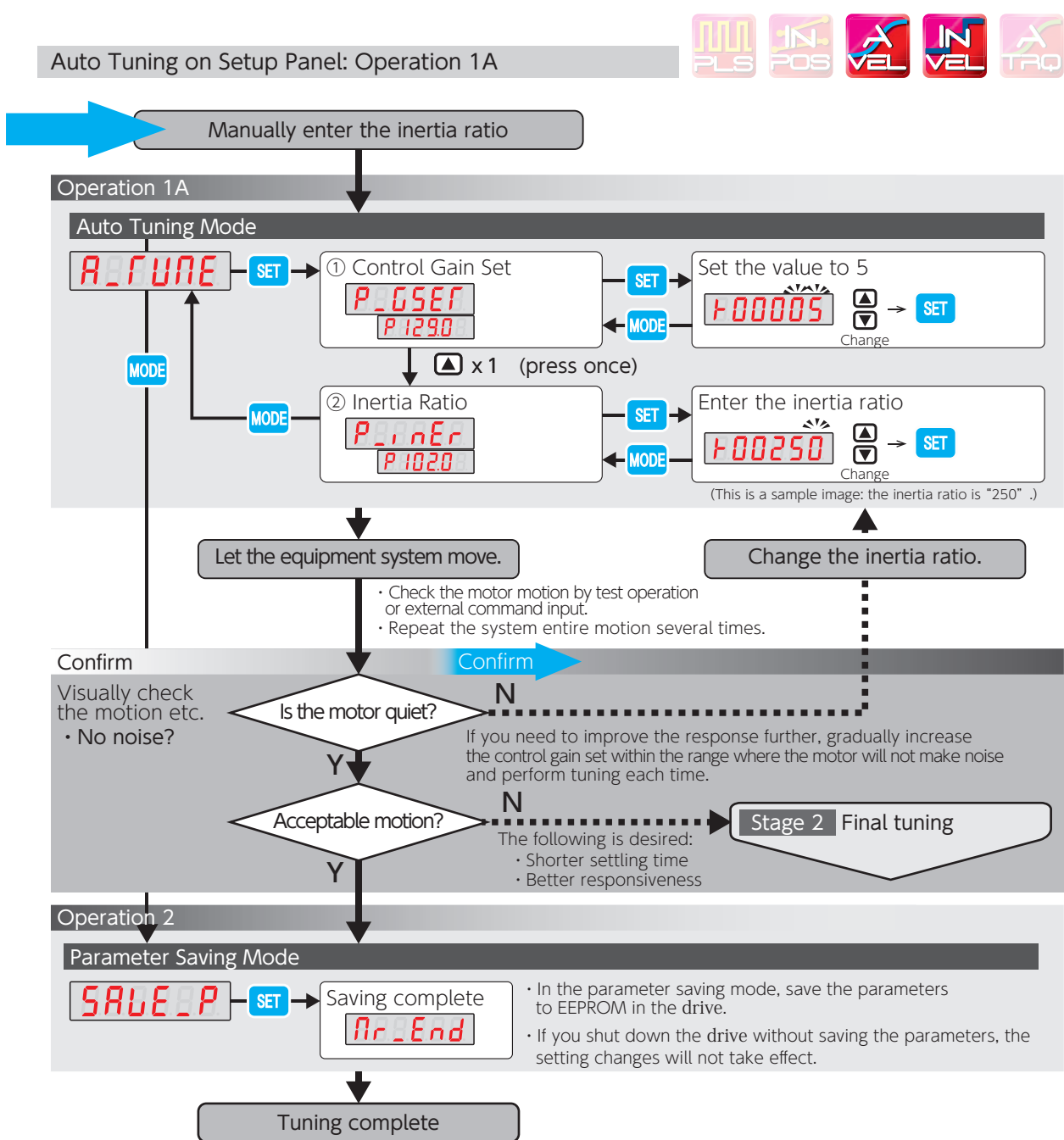

2. Tuning Procedure

Auto Tuning on Setup Panel: Operation 1A



Inertia ratio estimation by the auto tuning

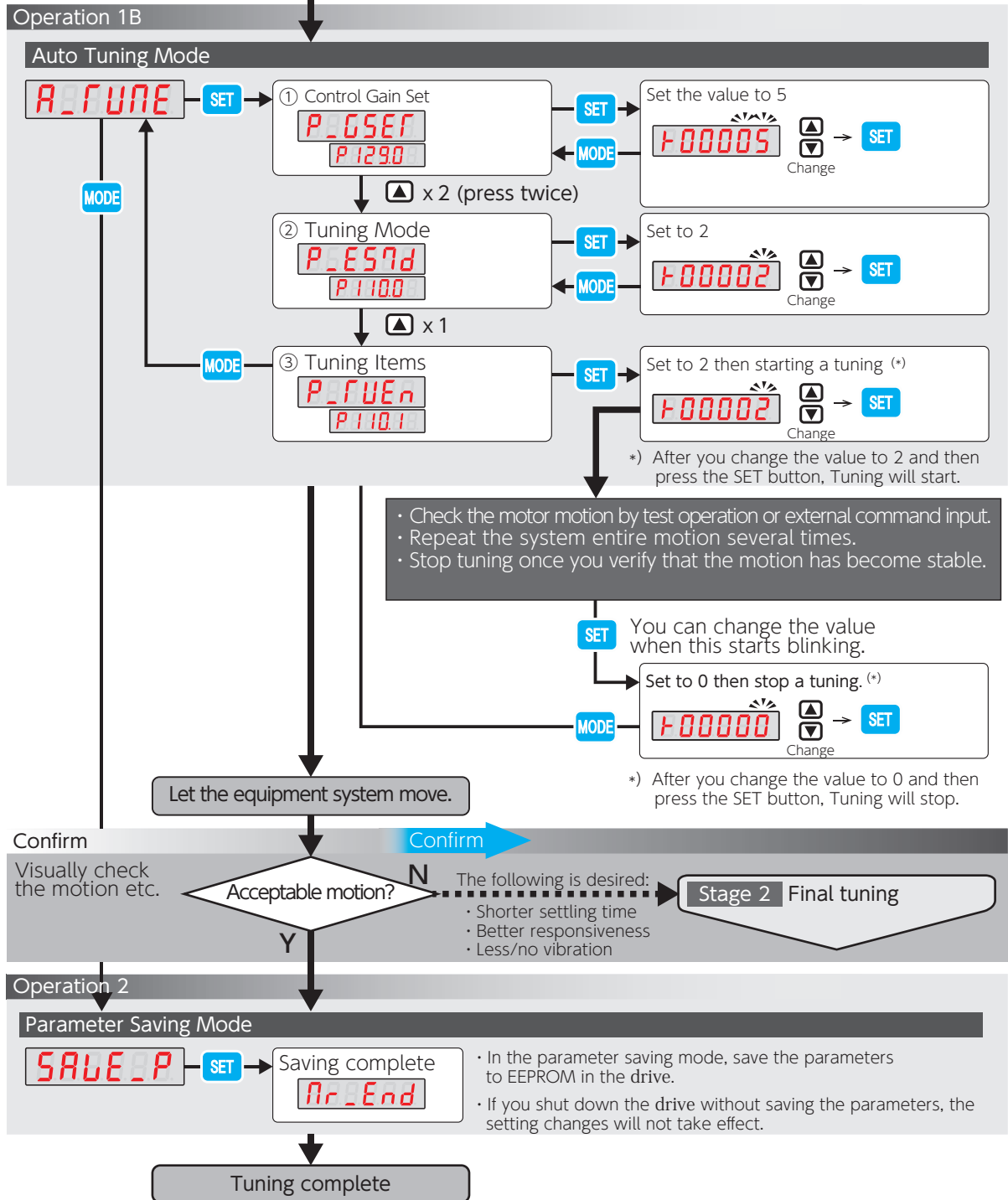



Confirm

Check the machine motion

Check the motor motion in test operation or by external command input.
Repeat the previous steps from the beginning.

Confirm

Select the Tuning tab

Waveform monitor tab

Select items to measure.

State Item tab

Select measurement conditions.

Waveform Record tab

Start Measuring

Click Capture waveform

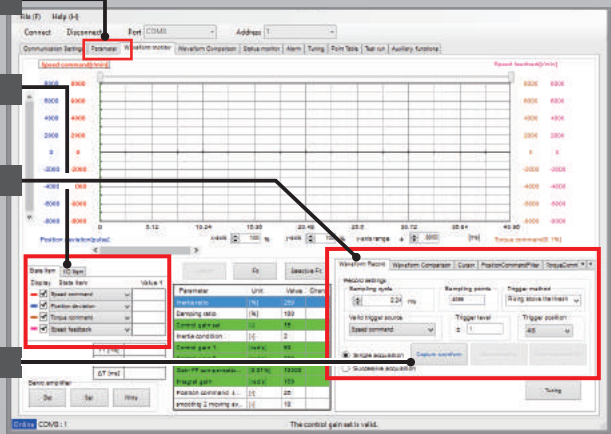

3. Tuning Parameters

1. Tuning

Inertia Condition



| | |
|-----------------|---|
| Function | To make the tuning operation easier, select the inertia condition suitable to your equipment. The inertia conditions that you select will determine the Control Gain 1-2 combination and their ratio. |
| Parameter 113.1 | Position Control Mode: Inertia conditions |
| Tuning Tip | Prioritize either stability or convergence according to the load and rigidity of your equipment. Be aware of the trade-off between stability and convergence. |

| Settings | Intended Use | Effect |
|----------------|---|--------|
| 1 | heavy-load, high fluctuation equipment low-rigid equipment robot arms etc. | |
| 2 (Default) | (moderate setting) general transport machines | |
| 3 | light-load equipment equipment that demands high-speed operation or settling-required | |

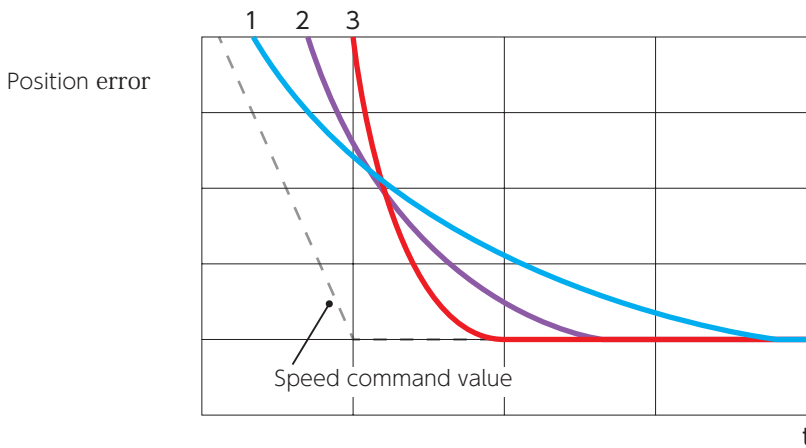

Difference in convergence characteristics depending on the inertia condition settings

Control Gain Set



| | | | |
|---------------|---|--|-------|
| Function | With this parameter, a set of the tuning parameters can be set all at once. ^{(*)1} Increasing the value of this parameter will improve the command response, position deviation during motion, settling time, and control rigidity. | | |
| Parameter Set | 113.0 (Position Control Mode) | Control level | 114.0 |
| | | Control Gain 1 | 115.0 |
| | | Control Gain 2 | 116.0 |
| | 129.0 (Velocity Control Mode) | Integral gain | 119.0 |
| | | Torque command filter: Low-pass filter time constant ^{(*)2} | 162.0 |
| | | Control level | 130.0 |
| | Control Gain 1 | 131.0 | |
| | Integral gain | 133.0 | |
| | Torque command filter: Low-pass filter time constant ^{(*)2} | 162.0 | |
| Remark | Too high a setting will cause noise. When increasing the value, check the resulting operation to avoid oscillation or vibration. | | |
| Tuning Tip | <ul style="list-style-type: none"> Set the value to 5 first to fix the inertia ratio. Gradually increase the setting value while watching the motion. If noise occurs, use a notch filter or decrease the low-pass filter setting. Page 42 Torque Command Filter: Notch filter Page 43 Torque Command Low-Pass Filter | | |

*1) In the Digitax SF Connect parameters grouped in the control gain set are highlighted in green.

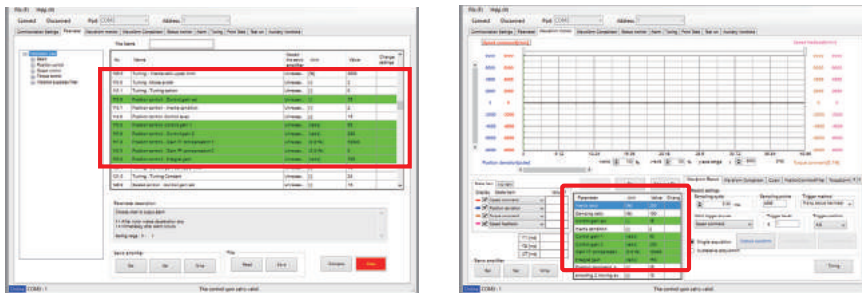

*2) This is when Low-pass filter auto Setting (160.2) = 1 (auto setting ON)

| Control gain set settings | Command Responsiveness | Rigidity | Settling Time | Noise |
|---------------------------|------------------------|----------|---------------|----------|
| 5 | slow | low | long | unlikely |
| 10 | ↑ ↓ | ↑ ↓ | ↑ ↓ | ↑ ↓ |
| 15 (Default) | | | | |
| 20 | | | | |
| 30 | quick | high | short | likely |

Under the Auto Tuning tab, tick the detail setup box, and then select from 1-46 one by one.

3. Tuning Parameters

Mode Switch



| | | | |
|--------------------|---|-------------------------|--|
| Function | Change the mode based on the direction of the load inertia and whether offset load is present or not. | | |
| Parameter 110.0 | Settings | Mode | Balanced load or unbalanced load |
| | 1 | Standard Mode | Balanced load (horizontal motion) |
| | 2 (Default) | Unbalanced Load Mode | Unbalanced load such as gravity is present |
| Remark | Use the Unbalanced Load Mode even for the case of balanced load (horizontal-axis motion). | | |
| Prerequisite | Position Control Mode, Velocity Control Mode | | |

Tuning Items



| | | | |
|--------------------|--|-----------------|-----------------|
| Function | Setting the item(s) to be estimated during tuning. | | |
| Parameter 110.1 | Settings (Tuning) | Estimate items | |
| | | Inertia ratio | Damping ratio |
| | 0 (Tuning Stop) (Default) | Do not estimate | Do not estimate |
| | 1 (Tuning Start) | Estimate | |
| 2 (Tuning Start) | Estimate | | |
| Prerequisite | Position Control Mode, Velocity Control Mode | | |

2. Final Tuning

Inertia Ratio



| | |
|-----------------|--|
| Function | <p>Set the ratio of the load inertia to the rotor inertia of the motor. This item represents the ratio of the motor axis moment of inertia to the load moment of inertia. The inertia ratio used in Digitax SF includes the motor rotor inertia (=100%).</p> <p>Example: inertia ratio 200% = motor rotor inertia 100% + output axis load 100% inertia ratio 1100% = motor rotor inertia 100% + output axis load 1000%</p> $\text{Inertia ratio} = \frac{(\text{load inertia}) + (\text{Rotor inertia})}{(\text{Rotor inertia})} \times 100 [\%]$ |
| Parameter 102.0 | <p>Default: 250 [%]</p> <p>Setting range: 100-10,000</p> |
| Remark | Settings that are not right for the equipment will cause noise or vibration. |
| Tuning Tip | <p>Start with setting a correct inertia ratio which will make your tuning easier.</p> <p>The auto estimate of inertia ratio during Quick Tuning will be capped by the upper limit (106.0). If the estimated value of the inertia ratio is higher than the upper limit, manually enter the estimated value after suppressing the vibration and noise with a notch filter first.</p> <p>Select the best inertia condition and set the control gain set (113.0, 129.0) to 5 to perform the quick-tuning and auto-tuning. In case of vibrations at settling, perform damping adjustment and perform tuning again. Because this tuning must be performed under the condition where the inertia can be estimated, we recommend that you obtain the ratio estimate in test operation.</p> |

Position Control Mode: Control Gain 1



| | |
|-----------------|--|
| Function | Increasing this parameter value will reduce the position error after the command becomes zero. Increase when the convergence of the position error at settling is not good. |
| Parameter 115.0 | Default: 50 [rad/s] Setting range: 5-1,000 |
| Remark | Select a value no higher than Position Control Mode: Control Gain 2 (116.0) . Set a value smaller than the value of Control Gain 2 (116.0) . Making a change to any of the following will also change other tuning parameters (such as Control Gain 2) to the prearranged parameter set all at once. <ul style="list-style-type: none"> • Control Gain Set (113.0) • Inertia conditions (113.1) • Control Level (114.0) |
| Tuning Tip | Increasing this parameter setting will improve the settling time in cases when increasing the control gain set or control level does not resolve poor convergence of position error, or noise is too much that the control gain set or control level cannot be increased. |

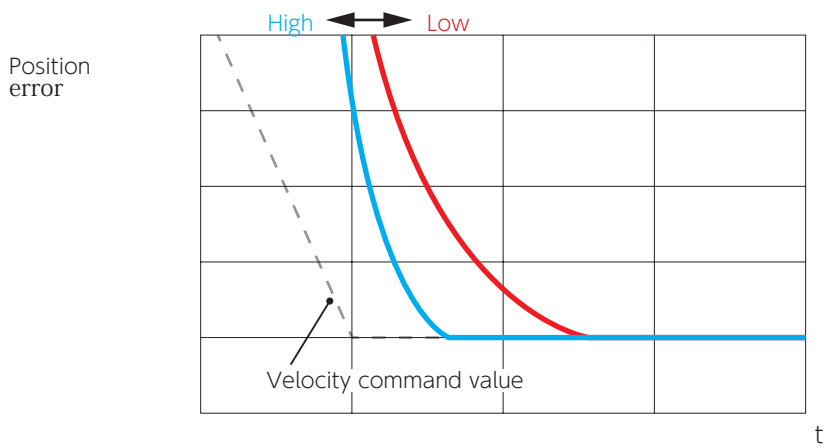

Differences in Position Error Convergence

Position Control Mode: Control Gain 2



| | |
|-----------------|--|
| Function | <p>Increasing this parameter value will reduce the position error during command input.</p> <p>Increasing the parameter value provides faster command response; however, too large a value may result in noise.</p> |
| Parameter 116.0 | <p>Default: 200 [rad/s]</p> <p>Setting range: 80-5,000</p> |
| Remark | <p>Set a value larger than the value of Control gain 1 (115.0). To reduce position errors after the command becomes zero, increase the value of Control gain 1 (115.0).</p> <p>The tuning parameters such as the Control gain 1 will be changed to the group of the preset value depending on changing the following parameters.</p> <ul style="list-style-type: none"> • Control gain set (113.0) • Inertia conditions (113.1) • Control level (114.0) |
| Tuning Tip | <p>Use this parameter when the load inertia or the load fluctuation is large. The responsiveness will be improved and the movement will be smoother.</p> <p><u>Noise Solutions</u></p> <ol style="list-style-type: none"> ① Use Torque command filter: Notch filter (such as 160.1). ② Lower Torque command filter: Low-pass filter constant (162.0). ③ Lower Integral gain (119.0). <p>When no improvement has been seen if these ①, ②, and ③ method had been performed, please decrease the 116.0 value.</p> |

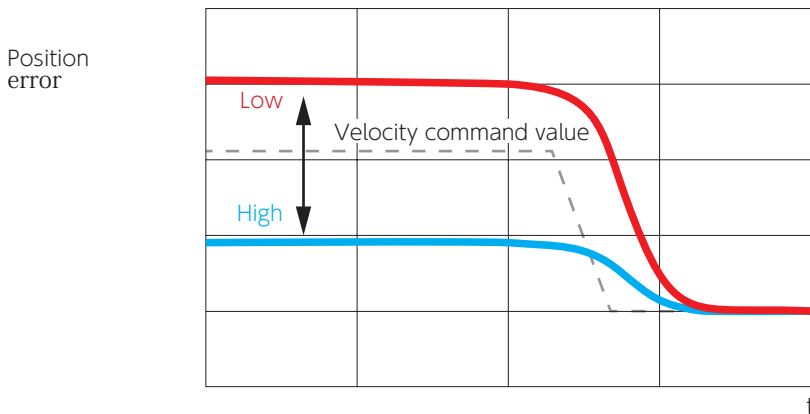

Differences in Position error Convergence

3. Tuning Parameters

Velocity Control Mode: Control Gain 1



| | |
|-----------------|--|
| Function | Increasing this parameter value will reduce the velocity error during the acceleration /deceleration. Increasing the parameter value provides faster command response; however, too large a value may result in noise. |
| Parameter 131.0 | Default: 399 [rad/s] Setting range: 100-6,000 |
| Remark | Making a change to any of the following will also change other tuning parameters (such as Gain FF Compensation 1) to the prearranged parameter set all at once. <ul style="list-style-type: none"> • Control gain set (129.0) • Control level (130.0) |
| Tuning Tip | Use this parameter when the load inertia or the load fluctuation is large. The responsiveness will be improved and the movement will be smoother. <p><u>Noise Solutions</u></p> <ol style="list-style-type: none"> ① Use Torque command filter: Notch filter (such as 160.1). ② Lower Torque command filter: Low-pass filter constant (162.0). ③ Lower Integral gain (133.0) <p>When no improvement have been seen if these ①, ②, and ③ method had been performed, please decrease the 131.0 value.</p> |

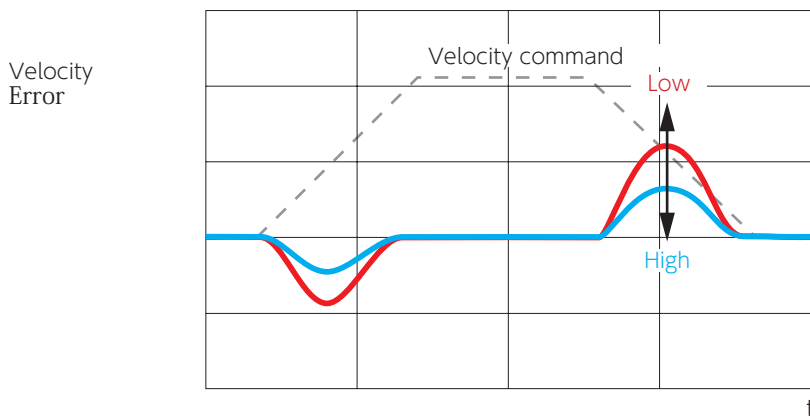

Differences in Velocity Error Convergence

Position Control Mode: Gain FF Compensation 1



| | |
|-----------------|---|
| Function | This parameter will improve the responsiveness at a low gains setting. Set the Feed Forward Compensation Rate (velocity) with respect to Control Gain 1 (115.0) for Position Control Mode. Using this parameter is effective to shorten the settling time. |
| Parameter 117.0 | Default: 10,000 [0.01%] Setting range: 0-15,000 |
| Remark | Adjust this item after setting the following: Control Gain Set (113.0) Control Level (114.0) Control Gain 1 (115.0) Control Gain 2 (116.0) <u>Guideline for Tuning</u> If the inertia ratio is right, setting this parameter to 10,000 will not cause overshooting nor undershooting. |
| Tuning Tip | <ul style="list-style-type: none"> Set the following before adjusting this parameter: Inertia ratio (102.0), Control gain set (113.0), Control level (114.0), Control Gain 1 (115.0), and Control Gain 2 (116) Setting this parameter too low will result in undershooting. Target the value which would make the settling time shorter. Too high a value of this parameter will result in overshooting. Set relatively a moderate value. <u>Inertia condition Coarse tuning amount</u> 1: increment by 10 2: increment by 100 |

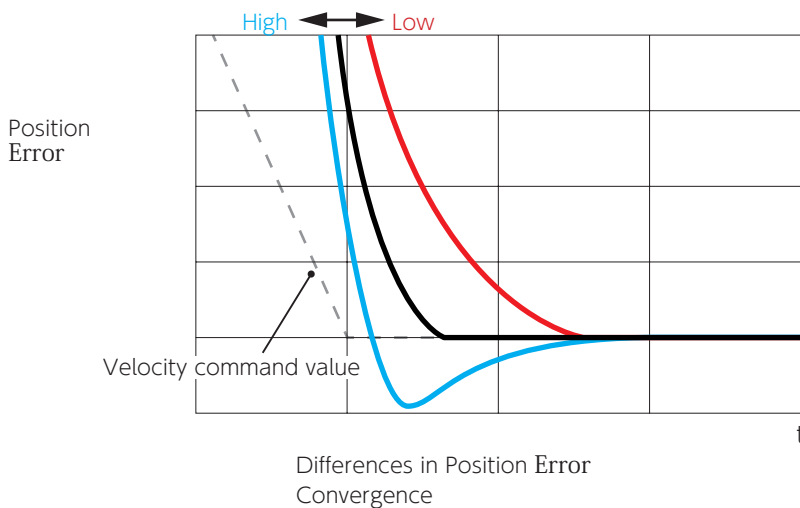

3. Tuning Parameters

Position Control Mode: Gain FF Compensation 2



| | |
|-----------------|--|
| Function | <p>Increasing this parameter value will reduce the position running error of the motor at a constant speed.</p> <p>Raise the value of this item only after reducing the position error, by using Gain FF Compensation 1 (117.0) at settling.</p> |
| Parameter 118.0 | <p>Default: 0 [0.01%]</p> <p>Setting range: 0-15,000</p> |
| Remark | <p>If this parameter value is above 10,000, the position error will start appearing appearing in a negative range.</p> <p>When the command resolution is low, increasing this parameter value will result in louder running sound.</p> |
| Tuning Tip | <p>With a right inertia ratio setting, setting this parameter to 10,000 minimizes the position error .</p> <p>Noise Solutions Adjusting Filter 4: Smoothing 2- Moving average counter (81.0) may reduce the noise.</p> |

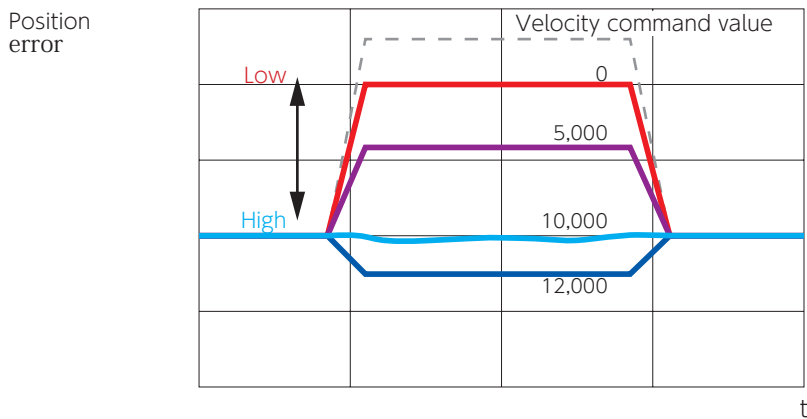

Differences in Position Error Convergence

Integral Gain



| | | |
|-----------------|---|---|
| Function | Set the Integral Gain. Increasing the integral gain will improve poor convergence due to friction and load fluctuation at settling and reduce the position error. This will result in rigid and sensitive motions. | |
| Parameter 119.0 | Position Control Mode | Default : 160 [rad/s] Setting range : 45-5,000 |
| Parameter 133.0 | Velocity Control Mode | Default : 300 [rad/s] Setting range : 45-5,000 |
| Remark | This parameter will reset to the default if the Control Gain Set is changed. Too high an integral gain will cause noise. Adjust the value within the range of no noise to achieve your desired responsiveness. | |
| Tuning Tip | Adjust the integral gain after setting the control level (or adjust Control Gain 1 and 2 each) and FF compensation. <u>Noise Solutions</u> ① Use Torque command filter: Notch filter (such as 160.1) ② Decrease the value of Integral Gain. If noise occurs, decrease the setting of this parameter or apply a torque command notch filter. | |

👉 Page 42 Torque Command Notch Filter

Overshooting Case

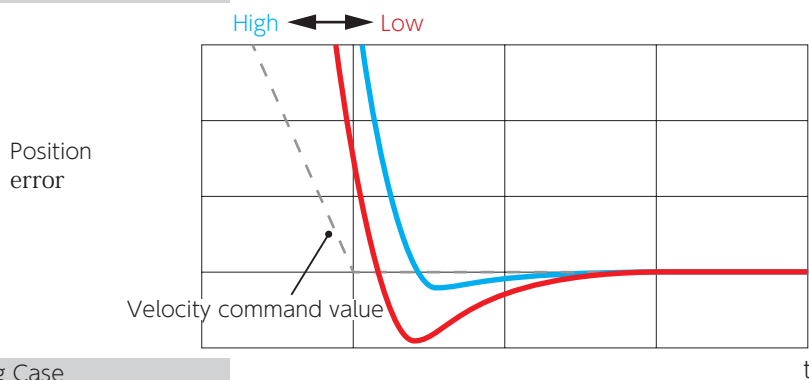

Undershooting Case

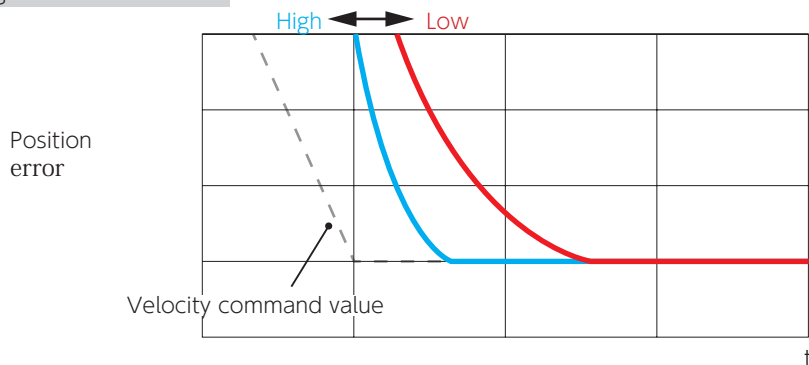

Differences in Position Error Convergence

3. Tuning Parameters

3. Position Command Filter

Optimizing the settling time and error / Suppressing vibration and noise





Check the following before using Position command filter

- The command from the host controller is correct.
- The equipment is installed firmly and properly.
- The gain parameters such as inertia ratio are correctly set.
- The command smoothing filters 2 (and 1) are set.
- Vibration is now unlikely to occur thanks to the decreased integral gain.

| Filter | Overview | Refer to |
|--|---|----------|
|  Smoothing | Position Command Smoothing Filter Effective in smoothing the position command and suppressing vibration at the time of positioning. | 38 |

Apply the following notch filters if the machine end point is still vibrating after sufficient tuning was performed and the smoothing filter was set.

| Filter | Overview | Refer to |
|--|--|----------|
|  Notch | Position Command Notch filter Effective in suppressing vibration of mechanical systems where the vibration does not appear in the torque output waveform. When compared to the command smoothing filter, the position command filter is more effective in reducing the absolute position error (Status No.80). | 37 39 |
|  γ -Notch | Position Command γ-Notch Filter Effective in suppressing vibration of mechanical systems where the vibration does not appear in the torque output waveform. This filter has flexibility of changing the gain setting in the range higher than notch frequencies. This item will reduce the position error impacted by use of notch filter. | 37 40 |

Up to four levels of Position command filter are available.

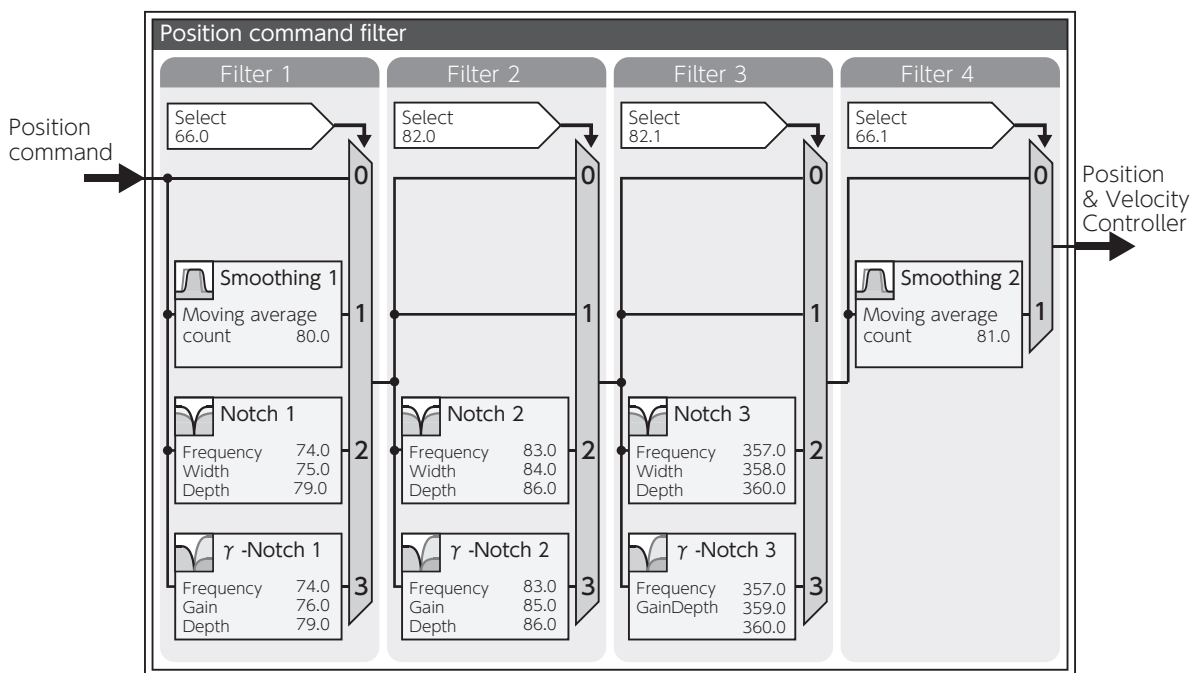

Block Diagram of Position Command Filter (Details)

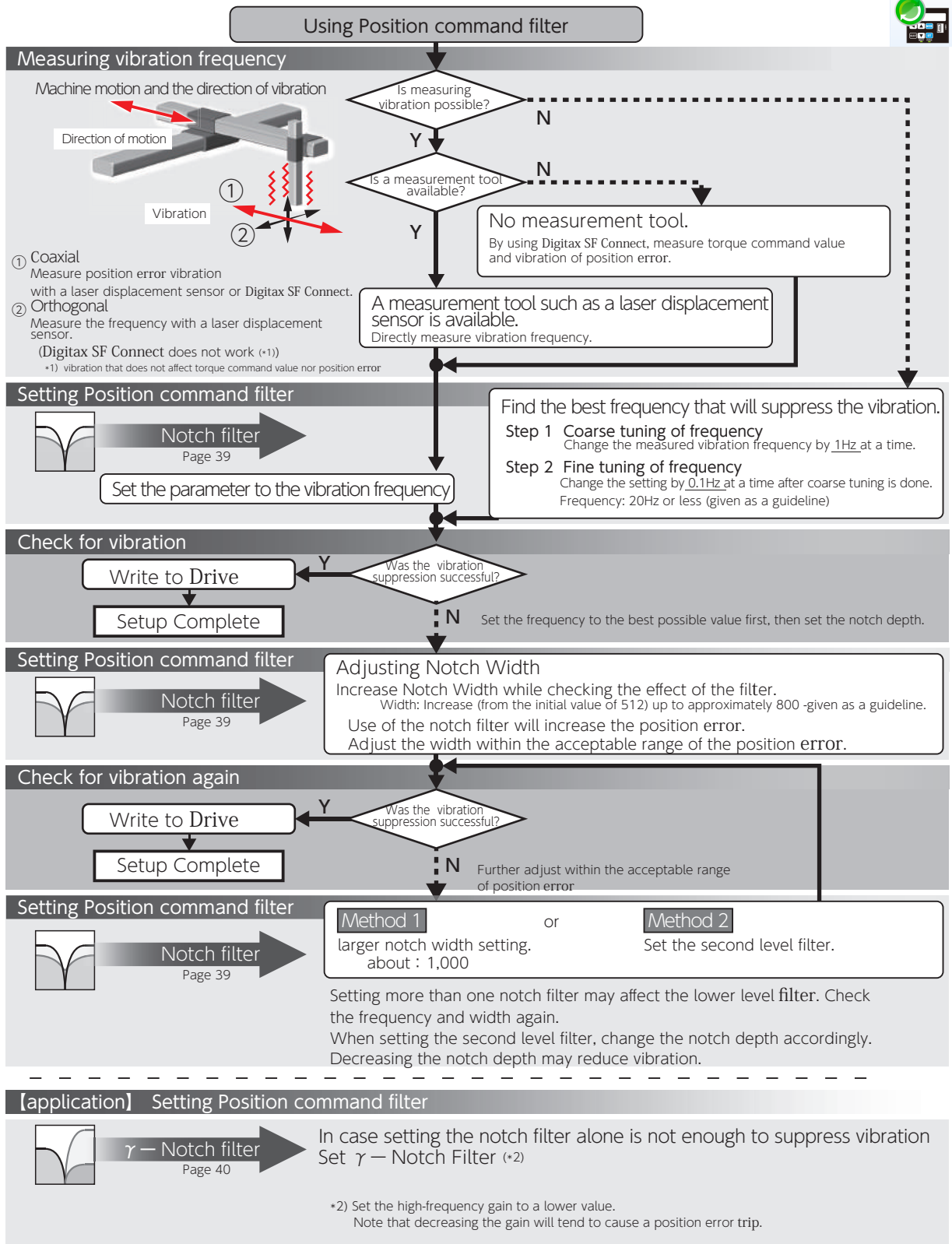

3. Tuning Parameters



Position Command Smoothing Filters 1 and 2



| Function | The smoothing filters smooth the position command and suppress vibrations. | | | | | | | | |
|-----------------------|---|------|--|-----------------------|---|---------------|-------|--------------|-------|
| Parameter | Position command filter 1: Type Select | 66.0 | Default: 0 Setting range: 0-3 | | | | | | |
| | Position command filter 4: Switch Select | 66.1 | Default: 1 Setting range: 0-1 | | | | | | |
| | Position command filter 1: Smoothing 1 -Moving average counter | 80.0 | Default: 25 (less than 750 W) 20 (over 1 kW) Setting range: 1-6,250 | | | | | | |
| | Position command filter 4: Smoothing 2 -Moving average counter | 81.0 | Default: 10 Setting range: 1-1,250 | | | | | | |
| Remark | Before setting any of the parameters, wait for at least 3 secs after the motor stops and then set it while the command pulse is not being input. Changing the parameter setting during pulse input or with presence of residual pulse could cause shift in position. The larger setting will result in longer command time delay. | | | | | | | | |
| Tuning Tip | <ul style="list-style-type: none"> • Set Position command filter 1: Type (66.0) and Position command filter 4: Switch (66.1) to "1" .(*) • Measure the vibration frequency on the torque command waveform or position error , and set Position command filter 1 (and 4): Smoothing 1 (and 2) -Moving average count (80.0 (and 81.0) to the value derived from the vibration frequency. Calculation formula: <table border="1" style="width: 100%; border-collapse: collapse;"> <thead> <tr> <th style="text-align: left;">Motor Output Capacity</th> <th style="text-align: left;">Moving Average Count Derived from Vibration Frequency</th> </tr> </thead> <tbody> <tr> <td>50 W to 750 W</td> <td>6,250</td> </tr> <tr> <td>1 kW to 2 kW</td> <td>5,000</td> </tr> </tbody> </table> <p style="text-align: center;">$\times (\text{vibration frequency}[\text{s}]) = \text{parameter value}$</p> <p>In the example below, when the vibration frequency is 39 ms, the average count = 6,250 x 0.039 = 242; the delay time will be 39 ms.</p> | | | Motor Output Capacity | Moving Average Count Derived from Vibration Frequency | 50 W to 750 W | 6,250 | 1 kW to 2 kW | 5,000 |
| Motor Output Capacity | Moving Average Count Derived from Vibration Frequency | | | | | | | | |
| 50 W to 750 W | 6,250 | | | | | | | | |
| 1 kW to 2 kW | 5,000 | | | | | | | | |
| | 5 Setting List of Parameters | | | | | | | | |

Example: 50 W to 750 W

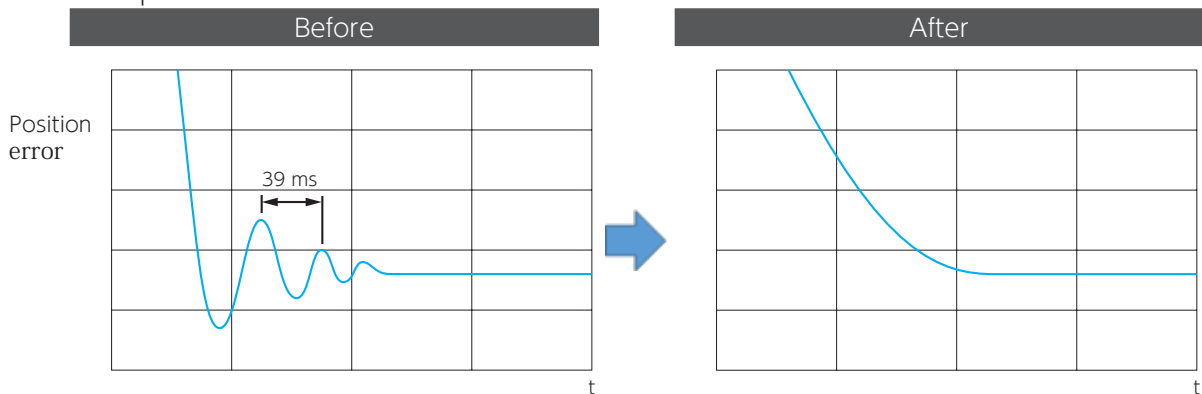

Effect of Smoothing Filter



Position Command Notch Filter



| | | | | | |
|------------|--|---|----------|----------|----------|
| Function | Apply this filter if the machine end point is still vibrating after sufficient tuning was performed and the smoothing filter was applied. Has vibration suppression effect on mechanical systems where the vibrations don't appear in the torque output waveform. When compared to the command smoothing filter, the position command filter is more effective in reducing the absolute position error(Status No.80). | | | | |
| Parameter | Frequency | Default: 10 [0.1 Hz] Setting range: 10-2,000 | Filter 1 | Filter 2 | Filter 3 |
| | Width | Default: 512 Setting range: 128-2,048 | 74.0 | 83.0 | 357.0 |
| | Depth | Default: 0 | 75.0 | 84.0 | 358.0 |
| | | Setting range: 0-100 | 79.0 | 86.0 | 360.0 |
| Remark | Increasing the notch width will make the position error large. Too large a notch width or setting the second level notch filter will result in better vibration suppression; however, the position error will be larger. Set this filter within the acceptable range of position error. | | | | |
| Tuning Tip | <p>Check the following before applying the filter</p> <ul style="list-style-type: none"> • The command from the host controller is reasonable • The equipment is installed firmly and properly. • The gain parameters such as inertia ratio are properly set. • The command smoothing filters 2 (and 1) are set. • The integral gain has been decreased and vibrations are unlikely to occur. <p>Start the equipment operation and apply the vibration frequency (measured at the equipment end) to the notch frequency. If the vibration cannot be suppressed, increase the notch width (by 800 as a rough standard). To reduce the position error during operation, increase the notch depth.</p> | | | | |

5 Setting List of Parameters

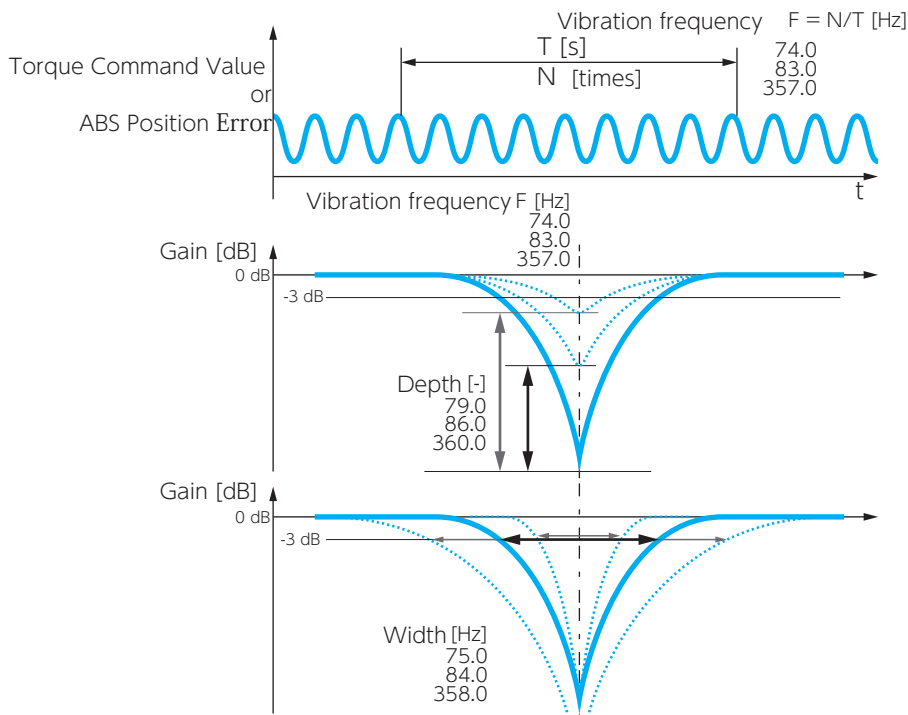

3. Tuning Parameters



Position Command γ -Notch Filter



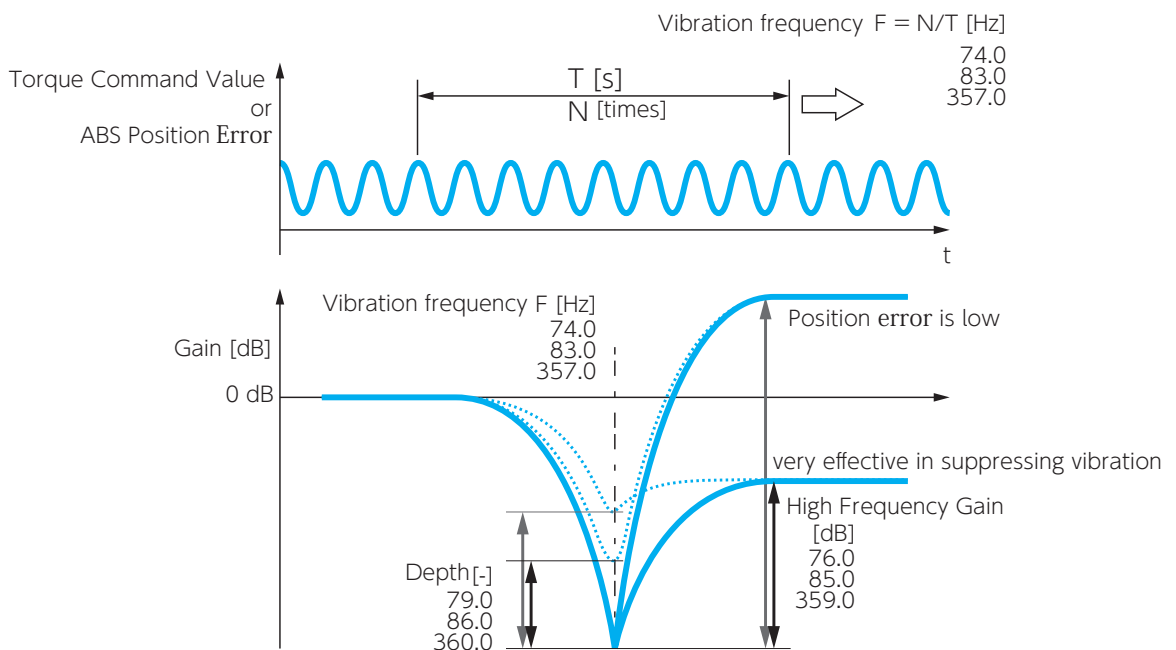

| | |
|------------|--|
| Function | <p>Use this filter, if the machine end point is still vibrating even after applying a notch filter in addition to sufficient tuning and a smoothing filter.</p> <p>This filter has vibration suppression effect on mechanical systems where the vibrations don't appear in the torque output waveform. It has flexibility of changing the gain setting in a range higher than notch frequency.</p> <p>Use this filter when it's expected that using a notch filter will reduce the position error.</p> |
| Remark | <p>Increasing the high frequency gain too much may result in noise.</p> <p>Decreasing the high frequency gain too much will tend to cause position error trip.</p> <p>Set this filter within the acceptable range.</p> |
| Tuning Tip | <p>Check the following before applying the filter</p> <ul style="list-style-type: none"> • The command from the host controller is reasonable • The equipment is installed firmly and properly. • The gain parameters such as inertia ratio are properly set. • The command smoothing filter 2 and 1 are set. • The integral gain has been decreased and vibrations are unlikely to occur. <p>Start the equipment operation and apply the vibration frequency (measured at the equipment end) to the notch frequency. To reduce the position error, gradually increase the high frequency gain setting.</p> <p>To reduce the position error during operation, increase the notch depth.</p> |

5 Setting List of Parameters



4. Torque Command Filter



| Filter | Overview | Refer to |
|---|--|----------|
|  Notch | Torque Command Filter: Notch Filter This filter is effective in removing vibration elements from torque command and suppressing noise and vibration. | 42 |
|  Low-pass | Torque Command Low-Pass Filter This filter is effective in smoothing the position command and <u>suppressing vibration at the time of positioning.</u> | 43 |

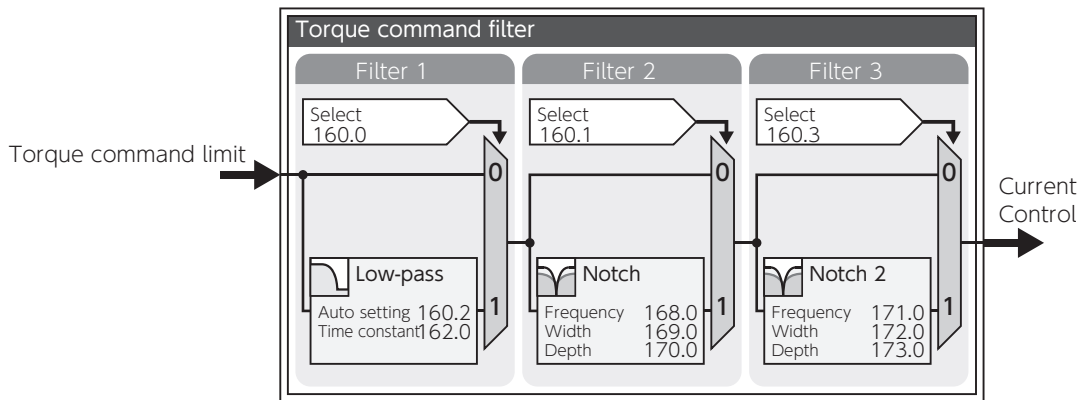

Block Diagram of Torque Command Filter with Details

3. Tuning Parameters



Torque Command Filter: Notch Filter



| | | | | |
|------------|--|---|-----------------------------------|----------|
| Function | This filter is effective in suppressing noise and vibrations by removing vibration factors from the torque command. | | | |
| Parameter | Notch filter | | Filter | Filter 2 |
| | Switch | Default: 0 Settings: 0-1 | 160.1 | 160.3 |
| | Frequency | Default: 2,500 [Hz] Setting range: 0-2,500 | 168.0 | 171.0 |
| | | Width | Default: 8 Setting range: 1-16 | 169.0 |
| | Depth | Default: 0 Setting range: 0-256 | 170.0 | 173.0 |
| Remark | Set this item only after the machinery is installed properly. Unless the equipment is installed correctly, the filter performance will be sub-optimal. | | | |
| Tuning Tip | <p>Set Notch filter switch (160.1) = 1(enable) and set the value of Notch filter frequency (168.0) to be a vibration frequency. Calculate the vibration frequency using the waveform of, for example, the torque command when vibration is occurring.</p> <p>In the case of multiple vibration frequencies, set the second level notch filter.</p> <p>Alternatively, use this filter together with the low-pass filter (160.0, 160.2, 162.0) or increase Notch filter - Width (169.0). If applying the notch filter cannot stop resonant vibrations due to considerable machinery rattles, increase Notch filter- Depth (170.0) to 50,100,150 and so on, so that the actual notch depth will be shallower.</p> <p style="text-align: right;"> 5 Setting List of Parameters</p> | | | |

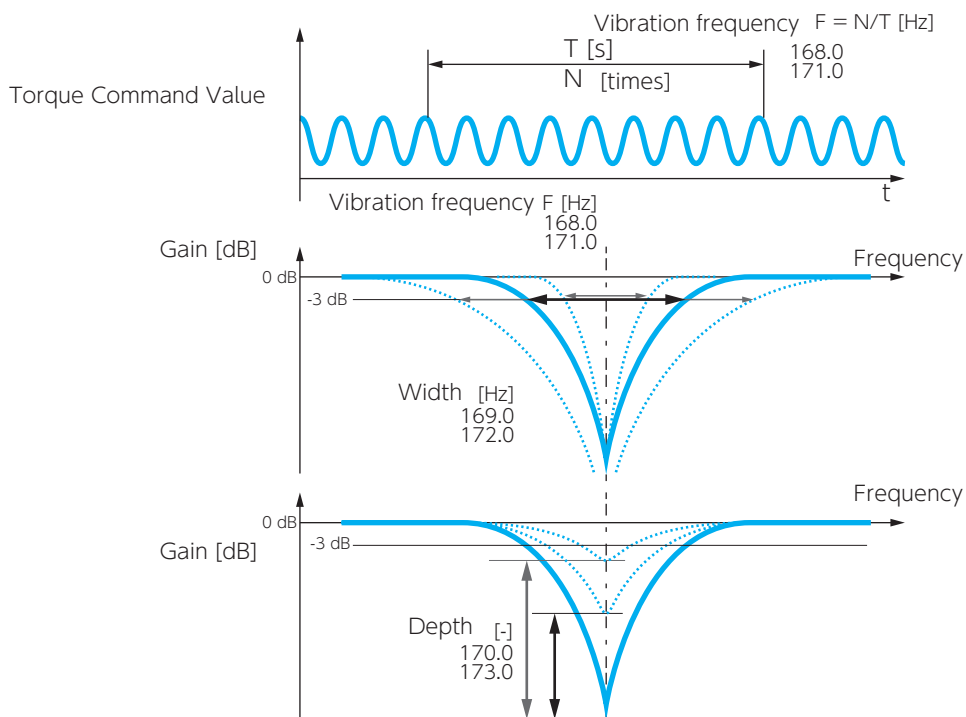

3. Tuning Parameters



Torque Command Low-Pass Filter





| Function | Setting a relatively large value may suppress vibrations. | | | | | | | | | | | | | |
|-------------------------------------|--|-----------------------|--|--|-----------------------|-----------------------|------------|----------------------|----------------------|------------|----------------------|---|------------|---------------------|
| Parameter | Switch | 160.0 | Default: 1 Settings: 0-1 | | | | | | | | | | | |
| | Auto setting | 160.2 | Default: 0 Settings: 0-1 | | | | | | | | | | | |
| | Time constant | 162.0 | Default: 0 [0.01 ms/rad] (less than 100 W) 10 [0.01 ms/rad] (over 200 W) Setting range: 0-65,535 | | | | | | | | | | | |
| Remark | Setting a larger value means getting closer to the control range of the response model: another type of vibration will occur. | | | | | | | | | | | | | |
| Tuning Tip | Set Torque command filter: Notch filter switch (160.1) =1 (enable). A rough estimate of possible max value for the filter can be obtained as follows. | | | | | | | | | | | | | |
| | $\frac{(0.1 \text{ to } 0.2)}{\max(\omega_1 + \omega_2, \omega_q)} \text{ [s] or below}$ <table border="1"> <thead> <tr> <th></th> <th>Position Control Mode</th> <th>Velocity Control Mode</th> </tr> </thead> <tbody> <tr> <td>ω_1</td> <td>Control Gain 1 115.0</td> <td>Control Gain 1 131.0</td> </tr> <tr> <td>ω_2</td> <td>Control Gain 2 116.0</td> <td>-</td> </tr> <tr> <td>ω_q</td> <td>Integral Gain 119.0</td> <td>Integral Gain 133.0</td> </tr> </tbody> </table> | | | | Position Control Mode | Velocity Control Mode | ω_1 | Control Gain 1 115.0 | Control Gain 1 131.0 | ω_2 | Control Gain 2 116.0 | - | ω_q | Integral Gain 119.0 |
| | Position Control Mode | Velocity Control Mode | | | | | | | | | | | | |
| ω_1 | Control Gain 1 115.0 | Control Gain 1 131.0 | | | | | | | | | | | | |
| ω_2 | Control Gain 2 116.0 | - | | | | | | | | | | | | |
| ω_q | Integral Gain 119.0 | Integral Gain 133.0 | | | | | | | | | | | | |
| 5 Setting List of Parameters | | | | | | | | | | | | | | |

4. Using Digitax SF Connect to Measure Vibration Frequency (FFT)

| | |
|--|--|
| <ol style="list-style-type: none"> 1 Load the waveforms measured or waveform data saved to display. (The example shown on the right is saved waveform data.) 2 Select a parameter of which the vibration frequency is to be investigated. Mark the check box to display the waveform. | |
| <ol style="list-style-type: none"> 3 Select Position Command Filter or Torque Command Filter 4 Select a range to investigate vibration frequency. If the position command filter or torque command filter is selected, the second cursor location of the chart will be determined based on the 1st cursor location such that the display range will contain 2nd sample points. 5 Click Frequency display . The x-axis unit will be changed from time [ms] to frequency [Hz]. The display unit of the graph in the range between the 1st and 2nd cursors will be converted to frequency. | |
| <p>When the x-axis unit on the graph is switched to frequency, the cursor colors will change. The table will show the frequency in red on column A and blue on column B.</p> <ol style="list-style-type: none"> 6 Read the peak value by using the cursor. 7 Click on Position Command Filter Adjustment or Torque Command Filter Adjustment . This will take you to the filter setup window under the tuning tab where a filter can be set. | |

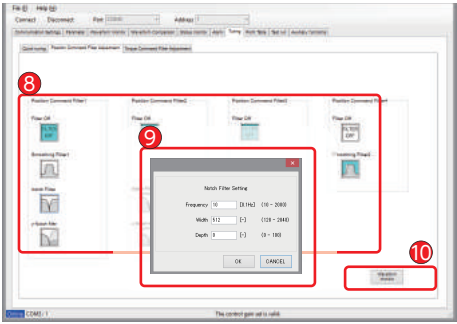
4. Using Digitax SF Connect to Measure Vibration Frequency (FFT)

| | |
|--|---|
| <p>8 Click on the icon for the filter that you want to set. Up to four levels of the position command filters and three levels of torque command filters are available.</p> <p>9 Set the filter parameters. For the notch filter, enter the vibration frequency measured.</p> <p>10 Click on Waveform monitor to return to the waveform monitor.</p> |  |
| <p>The filter that you just set will be shown on the list.</p> <p>11 Unchecking the check box will switch the effect of the filter ON/OFF</p> <p>Switch on to verify the filter effect. Switching off will not lose the filter parameter.</p> |  |

Tip for Notch Filter Setup

When you are setting a notch filter, use the initial value for the notch width and check the effect first. After setting the notch filter, start the equipment, verify the filter effect, and lower the notch frequency gradually. Measure the waveforms to find the best filter conditions such as frequency, width, and depth. The notch frequency varies depending on the equipment

| | |
|---|----|
| 1 . Checking Warnings and Alarms | 2 |
| 1. Using the Setup Panel | 2 |
| 2. Using Digitax SF Connect. | 4 |
| 2 . Warnings and Remedies | 5 |
| 1. Warning Output | 5 |
| 2. Warning Details | 6 |
| 3 . Alarms and Remedies | 8 |
| 1. List of Alarms | 8 |
| 2. Alarm Details | 9 |
| 4 . Troubleshooting | 17 |
| Problem 1 (No display on the Setup Panel) | 18 |
| Problem 2 (Servomotor not turning ON)..... | 19 |
| Problem 3 (No motor rotation) | 20 |
| Problem 4 (Unstable motor motion) | 21 |
| Problem 5 (Positional disturbance)..... | 22 |
| Problem 6 (Vibration and abnormal noise) | 23 |

8. Troubleshooting

1. Checking Warnings and Alarms

Warnings and alarm numbers can be viewed on the Setup Panel or Digitax SF Connect. When an alarm and a warning occur at the same time, the alarm will be displayed first. For possible cause and remedy, check the warning or alarm list.

The alarm history keeps up to ten alarms including the current one. (*)

*) Alarm No.22 (control power supply error) and Warning numbers are not logged in the alarm history.

The alarm numbers and the cumulative run time (in hours) up to the time of alarm are logged.

An alarm results in a drive trip and the motor will stop.

A warning does not result in a drive trip, motion continues but the warning state is entered.

Note: The drive version can be checked with Digitax SF Connect.

 Digitax SF Connect Instruction Manual

1. Using the Setup Panel

When a warning occurs, the drive STATUS LED blinks green. In addition, the Setup Panel will automatically display the corresponding warning No. 



When an alarm occurs, the drive STATUS LED changes from solid green to solid red. In addition, the Setup Panel will automatically display the alarm No. 

Note that the above does not happen in the following modes: Parameter Setting Mode, Quick Tuning Mode, Auto Tuning Mode, Parameter Saving Mode, and Auxiliary Function Mode. In these cases, press  to switch to Alarm Display Mode.

Status Display Mode will be suppressed / disabled while an alarm or warning is occurring.

Press   to check other warnings and alarms.

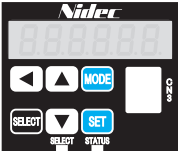
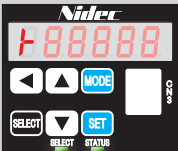
 5 Settings Setup Panel

| STATUS LED | Meaning | Symptom |
|---|-------------------------------|---|
| Off  | The drive is not ON. | The control power (24 VDC) is not supplied. Or the drive has not been started. |
| Solid Green  | Normal no warnings/alarms | Drive is operating normally. |
| Blinking Green  | Abnormal warning occurring | Warning is occurring |
| Solid Red  | Abnormal alarm occurring | Alarm is occurring |

1. Checking Warnings and Alarms

Checking the Alarm History on the Setup Panel

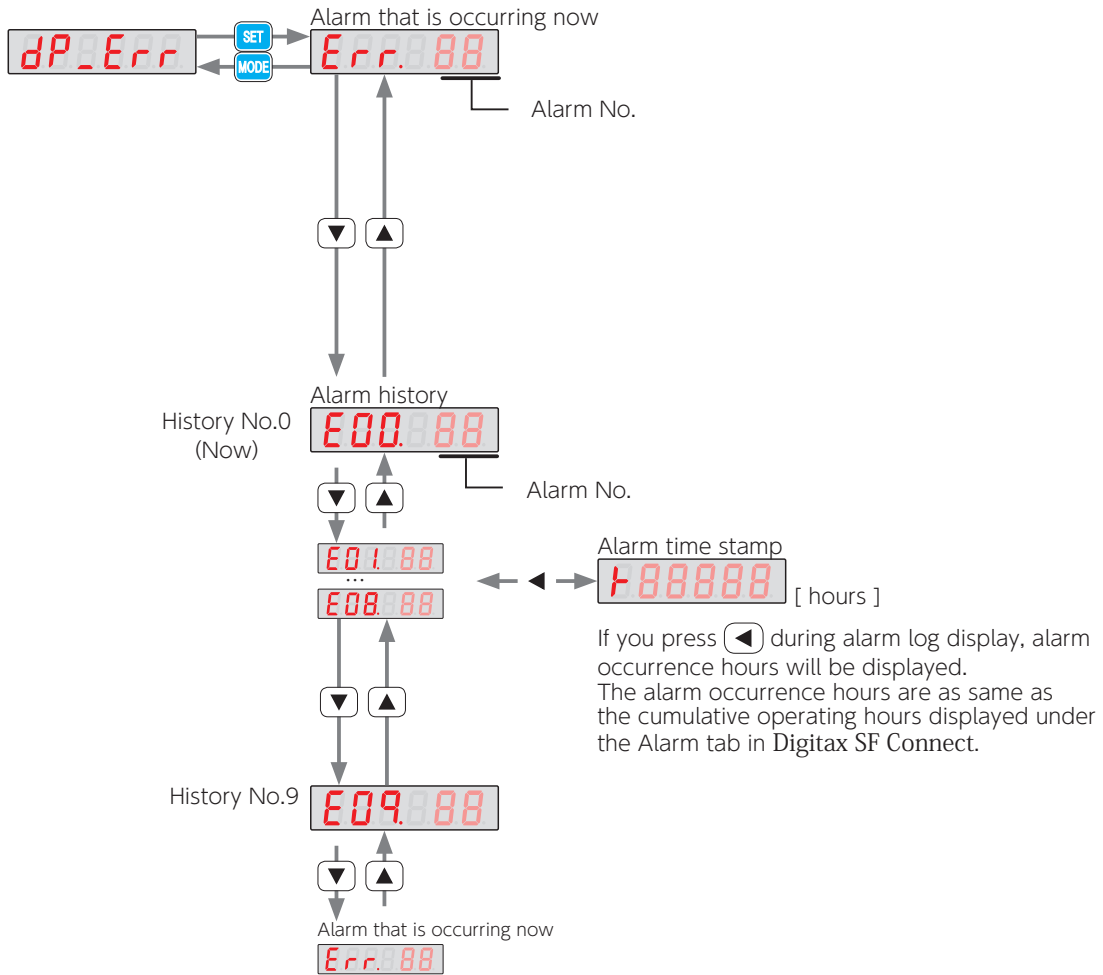

1. Checking Warnings and Alarms

2. Using Digitax SF Connect

Turn on the 24 VDC control power to the drive and start Digitax SF Connect.
 For information on the warning/alarm, check “Alarm currently occurring” under the [Alarm] tab.
 If you are not sure what to do, contact the supplier with the alarm number and its description for help.

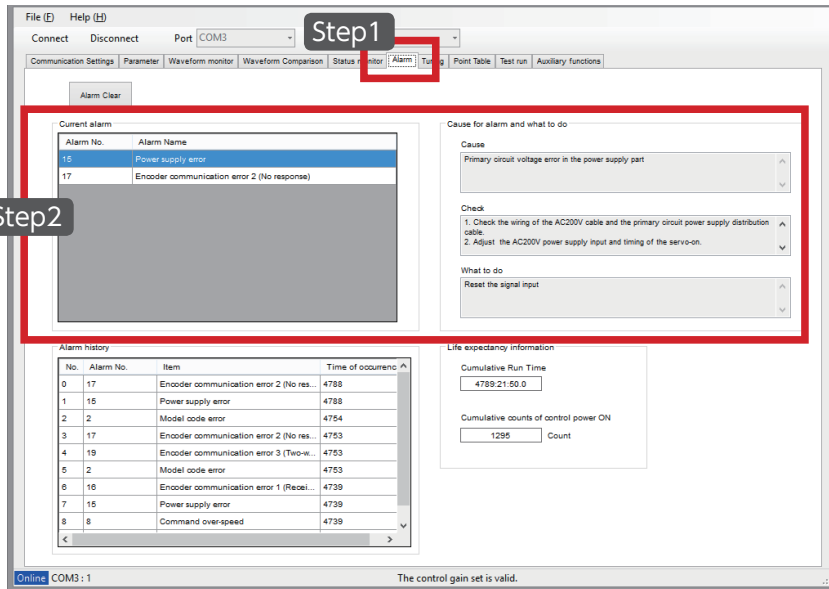

Step 1. Select the Alarm tab in Digitax SF Connect.
 Step 2. See [Current alarm] and [Cause for the alarm] and [What to do] windows for details.

Checking the Alarm History in Digitax SF Connect

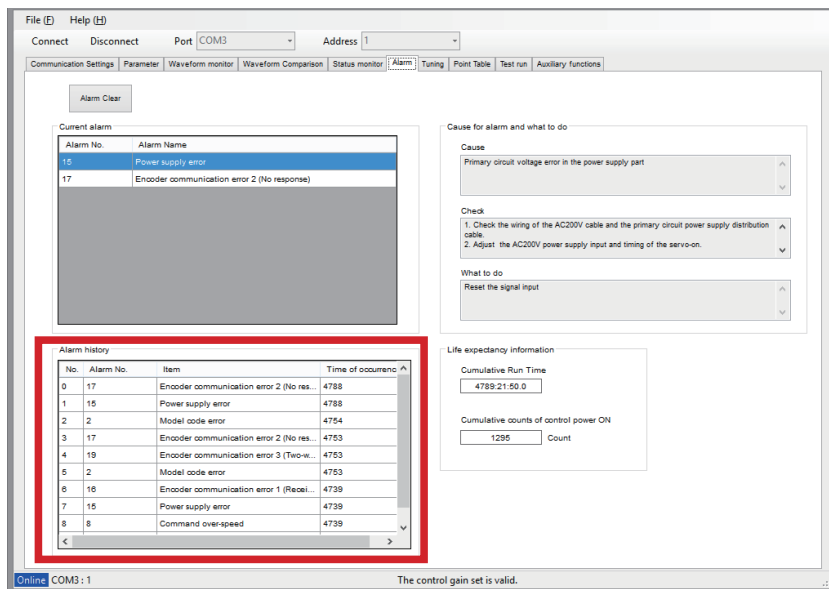

The alarm history area shows a list of the alarms.

2. Warnings and Remedies

1. Warning Output

There are 4 ways to output warnings.





1. I/O

While a warning is being output, the user I/O WARN1 (warning) becomes closed.

 [4 Connections](#) [Descriptions](#) [CN1 connector signals](#)

2. Setup Panel Output

During warning output, the warning number will appear on the Setup Panel.

| Warning No. | Warning Description |
|---|--|
|  | Encoder overheat detection |
|  | Encoder battery voltage drop error detection |
|  | Emergency stop |
|  | Encoder communication warning |
|  | Excessive position error |

3. RS-485 Communication

Warning status output with the RS-485 communication.

 [9 Appendices](#) [Status Display](#)

4. Digitax SF Connect

Select the Alarm tab in Digitax SF Connect.

See [Current alarm] and [Alarm history] windows for details.

 [Digitax SF Connect Instruction Manual](#)

2. Warnings and Remedies

2. Warning Details

| Warning No. | 900 | Encoder overheat detection |
|----------------------------|---|----------------------------|
| Symptom and Possible Cause | The temperature inside the absolute encoder has exceeded the temperature value specified by Encoder: Overheat detection - Value (267.0) . An alarm can be output in place of the warning. | |
| Remedy | Reduce the ambient temperature and improve thermal radiation conditions. Check the setting of Encoder: Overheat detection - Value (267.0) . | |
| Reset Method | After eliminating the cause, then input RESET signal to the RESET terminal on the connector CN1. | |

| Warning No. | 901 | Encoder battery voltage drop error detection |
|----------------------------|---|--|
| Symptom and Possible Cause | The battery voltage of the absolute encoder has dropped below the voltage set by Encoder: Battery voltage drop detection - Value (268.0) . | |
| Remedy | Replace the battery in the absolute encoder. Check the Encoder: Battery voltage drop detection - Value (268.0) . | |
| Reset Method | After eliminating the cause, then input RESET signal to the RESET terminal on the connector CN1. | |

| Warning No. | 902 | Emergency stop |
|----------------------------|--|----------------|
| Symptom and Possible Cause | The E-STOP control terminal digital input is open. | |
| Remedy | Close the E-STOP control terminal digital input Check for proper I/O connections. | |
| Reset Method | After eliminating the cause, then input RESET signal to the RESET terminal on the connector CN1. | |
| Related To | 9 Appendices Functions Emergency Stop | |

2. Warnings and Remedies

| Warning No. | 903 | Encoder communication warning |
|----------------------------|---|-------------------------------|
| Symptom and Possible Cause | Failed to obtain ABS encoder temperature and battery voltage data. | |
| Remedy | Check for wire disconnection or loose connection of pins. Keep the cable length no longer than 20 m. Check for noise interference. → Use a shielded twist-pair cable. → Keep the encoder cable away from the motor power cable. → Connect Ground/Earth FG firmly. → Use ferrite core for the motor power cable and encoder cable. If any of the above didn't resolve the issue, please contact the supplier. | |
| Reset Method | After eliminating the cause, then input RESET signal to the RESET terminal on the connector CN1. | |

| Warning No. | 904 | Excessive position error |
|----------------------------|--|--------------------------|
| Symptom and Possible Cause | The position error consecutively exceeded the setting of Position error warning detection: Value (363.0) and the setting of Position error warning detection: Delay time (365.0). | |
| Remedy | Adjust the tuning parameters. Check the command from the host controller. Check the wiring. Verify that the brake is released. Verify that the motor is not in a torque limit state per torque command limit. Check the settings of Position error warning detection: Value (363.0) and Position error warning detection: Delay time (365.0). | |
| Reset Method | After eliminating the cause, then input RESET signal to the RESET terminal on the connector CN1. | |

3. Alarms and Remedies

1. List of Alarms

| Alarm No. | Alarm Name | Refer to page |
|-----------|--|---------------|
| 0 | System | 9 |
| 1 | EEPROM data | 9 |
| 2 | Product code | 9 |
| 4 | Overspeed | 9 |
| 5 | Speed | 10 |
| 6 | Position | 10 |
| 7 | Overload | 11 |
| 8 | Command overspeed | 11 |
| 9 | Encoder pulse Output frequency | 12 |
| 10 | Positioning command overflow /Homing failure | 12 |
| 11 | Encoder (multi-turn counter overflow) | 12 |
| 12 | Overheat | 12 |
| 14 | Overvoltage | 13 |
| 15 | Power supply (AC Supply) | 13 |
| 16 | Encoder (received data) | 14 |
| 17 | Encoder (no response) | 14 |
| 18 | Encoder (circuit) | 14 |
| 19 | Encoder (communication) | 14 |
| 20 | Encoder (multi-turn data) | 14 |
| 21 | Encoder (voltage drop) | 15 |
| 22 | Voltage (control power) | 15 |
| 23 | Switch circuit | 15 |
| 24 | Overcurrent | 15 |
| 25 | Inverter 1 | 16 |
| 26 | Inverter 2 | 16 |
| 27 | Current sensor | 16 |
| 28 | Encoder (overheat) | 16 |
| 29 | Voltage drop (inside the drive) | 16 |

3. Alarms and Remedies

2. Alarm Details

| | | |
|----------------------------|--|--------|
| Alarm No. | 0 | System |
| Symptom and Possible Cause | Error in the control circuit The control circuit CPU is not operating normally. | |
| Remedy | Please contact the supplier of the drive | |
| Reset Method |  | |

| | | |
|----------------------------|--|-------------|
| Alarm No. | 1 | EEPROM data |
| Symptom and Possible Cause | Error during writing of Parameters | |
| Remedy | Check the interface cable and re-write the parameters. | |
| Reset Method |  | |



| | | |
|----------------------------|--|--------------|
| Alarm No. | 2 | Product code |
| Symptom and Possible Cause | Unable to read the product code The drive-motor pairing was wrong. The encoder cable was not connected to the drive correctly. (This includes wiring disconnection) | |
| Remedy | Check the motor-drive pairing. Check the encoder cable connections. | |
| Reset Method |  | |

| | | |
|----------------------------|--|-----------|
| Alarm No. | 4 | Overspeed |
| Symptom and Possible Cause | The motor rotational speed exceeded the rated maximum rotational speed. The command from the host controller was not appropriate. There were residual pulses due to drive limit switch input or other reasons. | |
| Remedy | Adjust the Tuning parameters. Check the command. Verify that the location of the limit sensor hasn't shifted. | |
| Reset Method |  | |

3. Alarms and Remedies

| | | |
|----------------------------|---|-------|
| Alarm No. | 5 | Speed |
| Symptom and Possible Cause | Position control/Speed control error The command was not appropriate. The load was too heavy and could not keep up with the command speed. Speed error detection: Value (90.0) was not appropriate. | |
| Remedy | Check the command from the host controller. Adjust the tuning parameters. Check the setting of Speed error detection: Value (90.0) . Verify that the brake is released. Verify that the motor is not in a torque limit state per torque command limit. | |
| Reset Method |  | |

| | | |
|----------------------------|---|----------|
| Alarm No. | 6 | Position |
| Symptom and Possible Cause | Position Control Error The acceleration time was too short There was wrong connection or disconnection of the motor power cable or encoder cable. Position error detection: Value (87.0) was not appropriate. | |
| Remedy | Adjust the tuning parameters. Check the command from the host controller. Check the wiring. Check the setting of Position error detection: Value (87.0) . Verify that the brake is disengaged. Verify that the motor is not in a torque limit state per torque command limit. | |
| Reset Method |  | |

| | | |
|---|--|---|
|  RESET Signal ① Eliminate the cause. ② input RESET signal to the RESET terminal on the connector CN1. |  Control-power cycle ① Eliminate the cause. ② Cycle control-power. |  CLEAR Encoder ① Eliminate the cause. ② Execute CLEAR Encoder ③ Cycle control-power. After power cycle, perform Homing. |
|---|--|---|

3. Alarms and Remedies

| Alarm No. | 7 | Overload |
|----------------------------|--|----------|
| Symptom and Possible Cause | <p><u>Immediately after the operation started</u></p> <ol style="list-style-type: none"> 1. The motor did not move at all. 2. The motor moved a little. 3. An alarm occurred after the motor started moving. <p><u>During operation</u></p> <ol style="list-style-type: none"> 4. An alarm occurred at the same point of the motion profile. The acceleration time was too short The motor was not accelerating when the alarm occurred. (The machine collided with some object.) 5. The motor capacity was too small (i.e. the load was too large) 6. The vibration was significant upon alarm occurrence. 7. Tuning parameters or command(s) were not appropriate. (The motor changed its rotational direction abruptly) 8. Noise was generated. | |
| Remedy | <p>Executing overloaded motion continuously may burnout the motor.</p> <ol style="list-style-type: none"> 1. Check the motor power cable connections. 3. Verify that the user-selected motor capacity is appropriate. Verify that the brake is disengaged. Verify that the deceleration ratio is appropriate. 4. During Acceleration - Check the acceleration time, torque wave form and load ratio. Not During Acceleration - Verify that there are no obstacles inside the work area of the equipment. 5. Check the torque waveforms and load ratio. Check the inertia ratio. Increase the motor capacity. Install a decelerator 6.7 Adjust the Tuning parameters. Verify that there are no commands to cause a sudden change in the motor rotational direction. Configure moderate commands, for example, use command smoothing filter. 8. Configure countermeasures for noise such as a notch filter or low-pass filter. | |
| Reset Method |  | |

| Alarm No. | 8 | Command overspeed |
|----------------------------|--|-------------------|
| Symptom and Possible Cause | <p>The position control input exceeded the max rotational speed. The command from the host controller was not appropriate.</p> | |
| Remedy | <p>Check the Pulse train command: Ratio (34.0 and 36.0). Check the commands from the host controller.</p> | |
| Reset Method |  | |

3. Alarms and Remedies

| Alarm No. | 9 | Encoder pulse - Output frequency error |
|----------------------------|--|--|
| Symptom and Possible Cause | The frequency of the encoder pulse output exceeded 4 Mpps. | |
| Remedy | Check the numerator and denominator settings in the Encoder pulse output: Pulse ratio (276.0 and 278.0). Check the settings of Encoder pulse output: Error detection - Frequency upper limit (285.0) and Encoder pulse output: Error detection - Delay time (286.0). | |
| Reset Method |  | |

| Alarm No. | 10 | Positioning command overflow /Homing failure |
|----------------------------|---|--|
| Symptom and Possible Cause | External position command exceeded the absolute value range of $\pm 1,073,741,823$. The shift amount per one of the commands exceeded the $\pm 2,147,483,647$ range. Homing failed and timed out. | |
| Remedy | Select a value different from the current setting of Internal Position: Overflow detection (643.0). Adjust the parameters such that the shift amount will be within the $\pm 1,073,741,823$ range. Adjust the shift amount of Positioner motion, inching and test each one. Adjust the Homing related parameters. | |
| Reset Method |  | |

| Alarm No. | 11 | Encoder(multi-turn counter overflow) |
|----------------------------|--|--------------------------------------|
| Symptom and Possible Cause | Multi-turn data of the encoder has exceeded the $\pm 32,767$ range. | |
| Remedy | Check the setting of Absolute system (257.0). Verify that the multi-turn motion amount is within the $\pm 32,767$ range. | |
| Reset Method |  | |

| Alarm No. | 12 | Overheat |
|----------------------------|--|----------|
| Symptom and Possible Cause | The control circuit temperature has exceeded the upper limit. | |
| Remedy | Check the drive's installation method and environment. Lower the ambient temperature to below the rating. | |
| Reset Method |  | |

3. Alarms and Remedies

| | | |
|----------------------------|---|-------------|
| Alarm No. | 14 | Overvoltage |
| Symptom and Possible Cause | The power supply to the control components has exceeded the drive circuit limits. | |
| Remedy | <p>If the alarm occurs only during deceleration By using the Setup Panel or Digitax SF Connect, check the regeneration status, which tells you if a braking resistor is necessary. If necessary, install a braking resistor. Check the motion patterns of commands. Use a command filter and gradually decrease the speed.</p> <p>If the alarm occurs regardless of deceleration Verify that the AC Supply is within specification. Check for voltage changes while the whole system is operating.</p> | |
| Reset Method |  | |

| | | |
|----------------------------|---|--------------------------|
| Alarm No. | 15 | Power supply (AC Supply) |
| Symptom and Possible Cause | <p>The AC Supply voltage is abnormally high or low. The AC Supply was not present. The AC Supply was not within the input range. The power supply fluctuated and exceeded the rated range. SVON signal was input without AC supply being present.</p> <p>Anomaly of the regenerative control circuit operating time lasted longer than a specific amount of time. Regeneration ON status too long</p> | |
| Remedy | <p>If the alarm occurred between servo on and operation startup Verify that the AC Supply is connected to the drive. Check the AC supply. Check the timing of AC Supply input and SVON signal input.</p> <p>If the alarm occurred during motor operation Check for no voltage fluctuations due to the whole system operation. Provide enough power supply so that the system experiences no voltage fluctuations.</p> <p>If the alarm occurs during deceleration Check the regenerative voltage warning signal on the Setup Panel or Digitax SF Connect. If a regenerative voltage warning occurs, install a braking resistor. Check the motion patterns directed by commands. Gradually decrease speeds by using a command smoothing filter.</p> | |
| Reset Method |  | |



RESET Signal

- ① Eliminate the cause.
- ② input RESET signal to the RESET terminal on the connector CN1.



Control-power cycle

- ① Eliminate the cause.
- ② Cycle control-power.





CLEAR Encoder

- ① Eliminate the cause.
- ② Execute CLEAR Encoder
- ③ Cycle control-power.
 After power cycle, perform Homing.

3. Alarms and Remedies

| | | |
|----------------------------|--|----------------------------------|
| Alarm No. | 16 | Encoder (received data) |
| Symptom and Possible Cause | Encoder data changed rapidly for a short period of time. | |
| Alarm No. | 17 | Encoder (no response) |
| Symptom and Possible Cause | Encoder communications were disconnected. | |
| Alarm No. | 19 | Encoder (communication) |
| Symptom and Possible Cause | The initial communication with the encoder failed. | |
| Alarm No. | 20 | Encoder (multi-turn data) |
| Symptom and Possible Cause | Absolute encoder data changed rapidly for a short period of time. At the time of starting, the encoder failed to receive multi-turn data internally. | |
| Remedy | <p>Check for wire disconnection or loose connection of pins. Keep the cable length no longer than 20 m. Check for noise interference.</p> <ul style="list-style-type: none"> → Use a shielded twist-pair cable. → Keep the encoder cable away from the motor power cable. → Connect Ground/Earth FG firmly. → Use ferrite core for motor power cable and encoder cable. <p>If any of the above didn't resolve the issue, please contact the supplier of the drive.</p> | |
| Reset Method |  | |

| | | |
|----------------------------|--|--------------------------|
| Alarm No. | 18 | Encoder (circuit) |
| Symptom and Possible Cause | <p>The battery voltage of the absolute encoder dropped or the battery became disconnected. (Alarm No.21 is output in this case) The encoder temperature has exceeded the specification and output data has become abnormal. Anomaly of the encoder itself has been detected.</p> | |
| Remedy | <p>If you are using an absolute system Replace the battery, connect it, and initialize the encoder.</p> <p>If you are not using an absolute system Check whether the encoder temperature is within specification.</p> <p>If any of the above didn't resolve the issue, please contact the supplier of the drive.</p> | |
| Reset Method |   | |

3. Alarms and Remedies

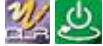



| Alarm No. | 21 | Encoder (voltage drop) |
|----------------------------|--|------------------------|
| Symptom and Possible Cause | The battery voltage dropped. The battery became disconnected. It was the first start-up after the battery was connected. | |
| Remedy | Check for low battery voltage. Check for loose battery cable. Initialize the encoder. | |
| Reset Method |  | |

| Alarm No. | 22 | Voltage (control power) |
|----------------------------|---|-------------------------|
| Symptom and Possible Cause | The control power supply dropped. | |
| Remedy | Check the control power supply. Check for insufficient control power supply capacity. Check the wiring of user I/O connector 24 V (Pin 1 and Pin 2). This alarm may be output at the same time as other alarms such as Alarm No.15 (Power supply). Check all the alarms that are occurring. This alarm will not remain in the alarm history. | |
| Reset Method |  | |

| Alarm No. | 23 | Switch circuit |
|----------------------------|---|----------------|
| Symptom and Possible Cause | Control circuit has failed. | |
| Remedy | Please contact the supplier of the drive. | |
| Reset Method |  | |

| Alarm No. | 24 | Overcurrent |
|----------------------------|---|-------------|
| Symptom and Possible Cause | Anomaly of motor control current inside of the drive has been detected. | |
| Remedy | Check the motor power cable. → Grounding fault → Wiring mistake in the motor power cable connection Check the Tuning parameters and motor motion patterns. → Increase the acceleration/deceleration time of command. → Enable/Disable Position command filter 1 and 4 (66.0, 66.1, 80.0, and 81.0). Allow motor motion by disengaging the brake or removing from the stopper. Check the encoder cable. → Connection (bad connection) → Use a twist-pair cable If any of the above didn't resolve the issue, please contact the supplier of the drive. | |
| Reset Method |  | |

3. Alarms and Remedies

| | | |
|----------------------------|---|--|
| Alarm No. | 25 | Inverter 1 |
| Symptom and Possible Cause | Anomaly in the control circuit has been detected. | |
| Alarm No. | 26 | Inverter 2 |
| Symptom and Possible Cause | Anomaly in the control circuit has been detected. SERVO ON timed out. | |
| Remedy | Check the motor power cable. → Grounding fault → Wiring mistake in motor power cable connections If any of the above didn't resolve the issue, please contact the supplier of the drive. | |
| Reset Method |  | |
| Alarm No. | 27 | Current sensor |
| Symptom and Possible Cause | The ambient temperature of the current sensor was high. Anomaly of the current sensor has been detected. | |
| Remedy | Check the installation method and environment. If any of the above didn't resolve the issue, please contact the supplier of the drive. | |
| Reset Method |  | |
| Alarm No. | 28 | Encoder (overheat) |
| Symptom and Possible Cause | The encoder PCB temperature has reached the upper limit. | |
| Remedy | Check the installation method and environment of the motor. Decrease the ambient temperature of the motor below the specification. | |
| Reset Method |  | |
| Alarm No. | 29 | Voltage drop (inside the drive) |
| Symptom and Possible Cause | The control power voltage (5 VDC) inside the drive has dropped. | |
| Remedy | Verify that there is no short-circuit in encoder cable connections. If the above didn't resolve the issue, please contact the supplier of the drive. | |
| Reset Method |  | |

4. Troubleshooting

Check the following if the drive does not start and the motor does not rotate although no alarm is output.

| Problem | Symptom | Refer to |
|---|--|----------|
| Problem 1 No display on the Setup Panel | Control power (24 VDC) is being supplied, but the Setup Panel does not light up . | 18 |
| Problem 2 No current flows to the motor | The Setup Panel shows, but the servo cannot be enabled. | 19 |
| Problem 3 No motor rotation | The motor does not rotate although the servo is on. | 20 |
| Problem 4 Unstable motor motion | The motor motion is unstable. | 21 |
| Problem 5 Positional disturbance | Positional disturbance occurs. | 22 |
| Problem 6 Vibration and abnormal noise | The motor causes vibration or abnormal noise. | 23 |

4. Troubleshooting

Problem 1 (No display on the Setup Panel)

Control power (24 VDC) is being supplied, but the Setup Panel does not light up.

| Cause | Remedy |
|---|--|
| The controller power 24 VDC is not connected to the user I/O connector. | Connect the 24 VDC to the user I/O connector. Connect the 24 VDC to Pin 1 and Pin 3 and GND to Pin 2 and Pin 12 respectively. |
| Loose user I/O connector | Connect the user I/O connector firmly. |
| The control power voltage is low. | Check the control power supply voltage capacity. |
| The drive has failed. | Please contact the supplier of the drive. |

4. Troubleshooting

Problem 2 (No current flows to the motor)



The Setup Panel shows, but the servo cannot be enabled.

| Cause | Remedy |
|---|---|
| The servo on signal (SVON) is not being input. | Input the SVON signal of the host connector to the user I/O connector. |
| The AC Supply is not present. (Alarm No.15 is displayed) | Verify that CHARGE LED is on. If it is off, verify that the AC supply connections are not loose, and the voltage is present. |
| The motor power connector is loose. | Connect the Motor Power connector firmly. |
| The drive has failed. | Please contact the supplier of the drive. |

4. Troubleshooting

Problem 3 (No motor rotation)

The servo is on, but the motor does not rotate.

| Cause | Remedy |
|---|---|
| The parameters are not set correctly. | Check the parameters required for the control mode that you are using.  6 Operations |
| Command from the host controller is not correctly input. | Check the command from the host controller. Use Digitax SF Connect to measure the waveforms of Pulse Train Command Input (position) or Analog Velocity Command Input and verify that normal commands are input. Check the parameters such as pulse ratio. It is possible that the motor is rotating very slowly. |
| The command input pins of user I/O connector are not connected correctly. | Check for correct I/O connections.  4 Connections |
| No command input is allowed. | Open HOLD and COM- pins of the user I/O. |
| Torque command limit is not set correctly. | Verify that Torque command limit: Value 1 and Value 2 (147.0, 148.0) are set correctly. |
| CCW/CW drive limit switch input is enabled. | If CCW/CW drive limit switch input is not required, set Drive limit switch input: Setup (67.0) to 0 (disable). If it is enabled and required, connect both CCWL and CWL pins of the user I/O connector with either "COM- " or "closed" each. |

4. Troubleshooting

Problem 4 (Unstable motor motion)

The motor does rotate, but motion is unstable.

| Cause | Remedy |
|--|--|
| Ground/Earth FG and GND are not connected correctly. | Connect Ground/Earth FG and GND correctly. |
| Speed/Position commands are unstable. | On the waveform monitor in Digitax SF Connect, check the command from the host controller. Check for proper connection of the I/O connector. |
| Tuning is incomplete. | Adjust the parameters. |
| The motor rotates with no host command input. | <p><u>In Position Control Mode</u> Set Pulse train command: Input filter (33.0) to an appropriate value.</p> <p><u>In Velocity Control Mode</u> Adjust Analog velocity: Offset value (60.0).</p> <p><u>In Torque Control Mode</u> Adjust Analog torque: Offset value (300.0)</p> |

4. Troubleshooting

Problem 5 (Positional disturbance)

The motor does rotate, but position disturbance occurs.

| Cause | Remedy |
|--|---|
| <p>The command signal has electrical noise present.</p> | <p>In Position Control/Pulse Train Command Set Pulse train command Input filter (33.0) to an appropriate value.</p> <p>Check the following three items.</p> <ol style="list-style-type: none"> 1. Status No.33 (Pulse Train Command Input (position) agrees with the host controller output. 2. Status No.65 "Position command" and Status No.67 "Position feedback" agree. 3. (Status No.67) × (Encoder pulse ratio (276.0/278.0)) = (Position feedback from the host control device) <p>If the above do not solve the problem, take countermeasures for noise.</p> <p>Connect Ground/Earth FG correctly.</p> <p>Adjust Pulse train command: Input filter (33.0)</p> <p>Select a shielded twist-pair wire for the I/O cable.</p> <p>For the encoder cable, select a shielded twisted-pair wire of no longer than 20m.</p> |
| <p>The position error is not converging.</p> | <p>Verify that Status No.65 (Position command value) and Status No.67 (Position feedback) agree.</p> <p>If not, adjust the tuning parameters.</p> |
| <p>The host controller is not obtaining encoder Z-phase correctly.</p> | <p>Check the command from the host controller.</p> <p>Use Digitax SF Connect to measure the waveforms of Status No.33 "Pulse Train Command Input (position)" or Status No.49 "Analog Velocity Command Input" to verify that a normal command is input.</p> <p>Verify that the host controller is obtaining Z-phase correctly. If the Z-phase pulse width is too small, increase the pulse width by using the Encoder pulse ratio (276.0/278.0) As a rule of thumb, a pulse width of 1 ms or above is required for PLC.</p> |
| <p>Output pulse frequency of the host controller is above the upper limit.</p> | <p>Verify that the output pulse frequency of the host controller such as PLC is not above the upper limit.</p> |
| <p>A resistor is installed in the pulse output circuit of the host controller (PLC).</p> | <p>Verify that there is no built-in resistor in the pulse output terminal.</p> <p>The output resistor of the host controller and the input resistor of servo drive being connected in series prevents correct command signal from being input to the drive.</p> |

4. Troubleshooting

Problem 6 (Vibration and abnormal noise)

The motor is experiencing vibration or abnormal noise.

| Cause | Remedy |
|--|---|
| Tuning parameter settings are not appropriate. | Set the Control Gain 1, Control Gain 2, Integral Gain to lower values. Especially for very rigid equipment such as ball screws, set the Current control gain (193.0) to 1 if noise occurs at servo-on stop.  7 Tunings |
| Loose Mechanical Couplings | Check the installation of the motor, decelerator, couplings, and so on. |
| Noise interference is occurring. | Check the length or shield of each cable. Separate the high voltage cable such as motor power cable from the signal cable such as encoder cables. Avoid parallel cable runs |
| The equipment and the motor are resonating. | For low-frequency vibration, adjust the position command smoothing filter. For high-frequency vibration, adjust the low-pass filter or notch filter. |
| Motor load is substantially large (*) (Alarm No.7 is displayed) | Set the inertia condition parameter to "Heavy" Keep adjusting the Position Command Smoothing Filter to smooth the command until the vibration at the time of acceleration becomes eliminated. Set the Inertia ratio (102.0) to 3,000. To stabilize the motion, increase Integral gain value according to Control Gain 1 and Control Gain 2. |
| The current pairing of drive and motor is not right. | Check the motor model code under "Communication Settings" tab in Digitax SF Connect. In case of incompatibility, clear the parameters saved in EEPROM and change the motor. |

*) This problem may occur in a low-rigidity case such as belt drive if the load inertia ratio is over 30 times.

| | |
|---|-----------|
| 1. Absolute System. | 2 |
| 1. Overview. | 2 |
| 2. System Configuration. | 3 |
| 3. Backup Battery | 4 |
| 4. Absolute Encoder Cable | 6 |
| 5. Initializing Absolute Encoder. | 7 |
| 6. Obtaining Absolute Data. | 11 |
| 7. Alarm. | 13 |
| 2. Function | 15 |
| 1. Emergency Stop | 15 |
| 3. Technical Data | 16 |
| 1. Drive Circuit Block Diagram. | 16 |
| 4. Status Display. | 17 |
| 1. Introduction | 17 |
| 2. List of Status Variables. | 18 |
| 3. Details of Each Status Variable. | 19 |
| 5. How to set Pulse the train command: Input filter (33.0) | 32 |

1. Absolute System

1. Overview

By using the absolute system, you do not have to perform Homing after cycling power.

Preparations

To configure an absolute system, prepare the following items.

- ① A motor equipped with absolute-encoder and a drive that supports absolute system.
- ② A backup battery
- ③ An absolute encoder Cable

 Page 4 Backup Batteries

 Page 6 Absolute Encoder Cable

Checking the model code

Select the model code that support absolute systems.

Motor Product Code :





| | | | | | | | | |
|-----------|------------|----------|----------|----------|----------|----------|----------|--|
| MX | 201 | N | 2 | S | A | * | * | |
|-----------|------------|----------|----------|----------|----------|----------|----------|--|

| Encoder | |
|----------|----------------------|
| Code | Specifications |
| N | 17 bit (Incremental) |
| A | 17 bit (Absolute) |

1. Absolute System

2. System Configuration

Connection Method

1. To ensure safety, isolate the AC Supply and the control power first, and then connect the absolute encoder cable.  Refer to the figure below.
2. Be sure of the right connecting polarity, and connect the backup battery correctly.  Page 4 Backup Batteries
3. After connecting the battery, secure the battery to the absolute encoder cable by using a cable tie.  Page 5 Securing the battery
4. Initialize the absolute encoder.  Page 7 Initiating Absolute Encoder

Cable and Battery Connections

Drive

50W 100W 200W 400W 750W 1kW 1.5kW 2kW

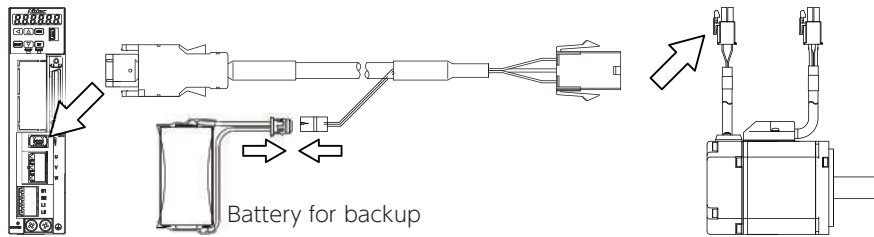

Drive

50W 100W 200W 400W 750W 1kW 1.5kW 2kW

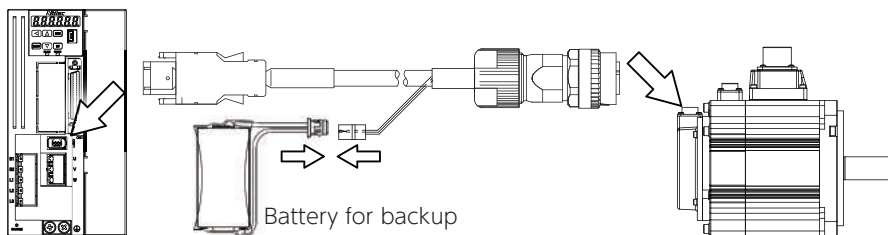

1. Absolute System

3. Backup Battery

Recommended Specifications

| Item | Specifications | Remark |
|--------------------------------------|---|---|
| Model Code | CR17335E-R-CH3 | Manufactured by FDK (*) Series battery : CR17335E-R |
| Nominal Voltage | 3.0 V | - |
| Nominal Capacity | 1,600 mAh | Nominal capacity is determined at the voltage of 2.0 V when the battery was discharged at a standard current level under the 23 °C environment. |
| Maximum Continuous Discharge Current | 500 mA | Under the 23 °C environment |
| Dimensions | See the figure below. | |
| Exterior | Insulation tubing | - |
| Terminal | Housing : DF3-2S-2C Contact : DF3E-2428SCFC Lead wire : UL 1007 AWG26 Red (+), Black (-) | Connector: Hirose Electric |
| Mass | 17 g | |
| Temperature Range | Operating temperature : - 40 °C to +70 °C | No condensation |
| Recommended Storage Conditions | Temperature : 10 °C to 30 °C Humidity : 60 % RH or less | - |

*) This is a primary lithium battery. Do not try to charge it, or it may explode.

Dimensions

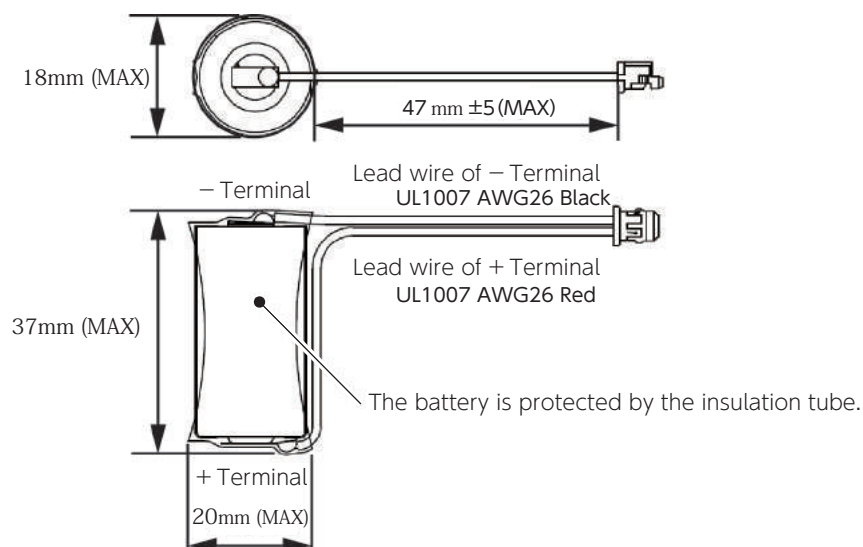

Precautions for Battery Storage and Installation

- Avoid places subject to any of the following:
- Direct sunlight, rain drops
 - Corrosive atmosphere, oil mist, or iron powder
 - Poor ventilation or high humidity
 - Dirt or dust
 - Vibration
 - Impact to the installed battery

Securing the Battery

1. Securing the Battery

Secure the battery to the cable, for example, using a cable tie. We recommend using a cable tie tensioning tool. Holding strength of the cable tie should be 11.6 to 44.2 [N].



2. Protecting the Battery Connector Part

Protect the exposed part of the battery connector terminal with a heat shrink tube.



Replacing the Battery

When the battery voltage drops, Alarm No.21 (Encoder voltage drop) occurs. In this case, you need to replace the battery with a new one.

When replacing the battery, be sure to keep the control power (24 V) of the drive ON. Otherwise, you will lose the multi-turn data and need to perform homing again.



CAUTION



- Be careful not to connect the battery the wrong way round.
- Do not attempt to disassemble the battery.
- Do not short circuit the battery.
- Never attempt to charge the recommended battery.



Disposal of Batteries

Dispose of used batteries according to local government regulations.

1. Absolute System

4. Absolute Encoder Cable

Recommended Products

You can purchase recommended cables from your supplier

 3 Preparation

1. Absolute System

5. Initializing Absolute Encoder

When using an absolute system for the first time or using it after replacing the motor, you need to initialize the encoder.

Use the Encoder Clear function by using the Setup Panel or Digitax SF Connect to initialize the encoder. And then restart your drive.

Only multi-turn data will be initialized and single-turn absolute data will not.



Initialize the absolute encoder before performing homing.



1. Absolute System

Initializing Encoder with Setup Panel

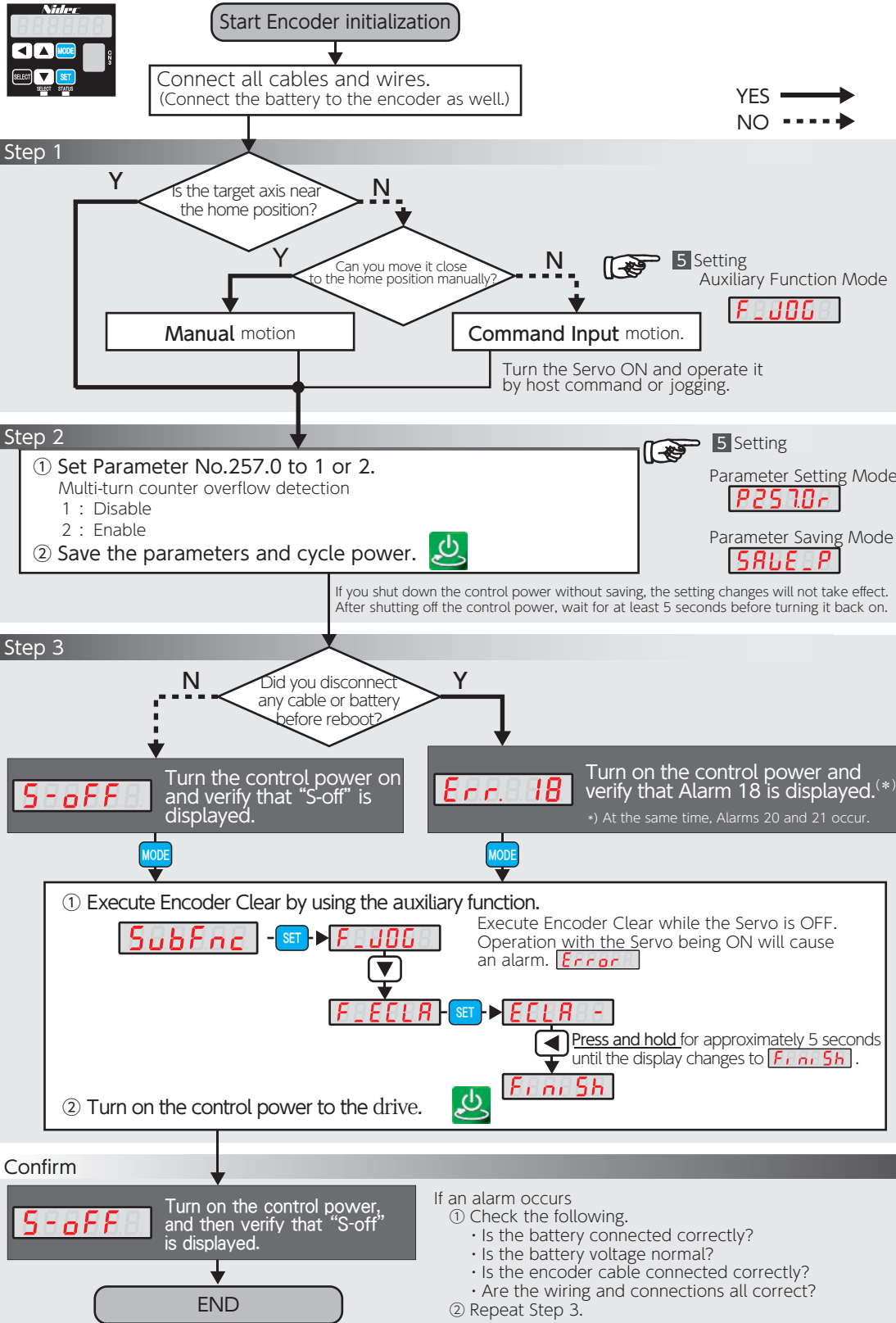

1. Absolute System

Initializing Encoder with Digitax SF Connect

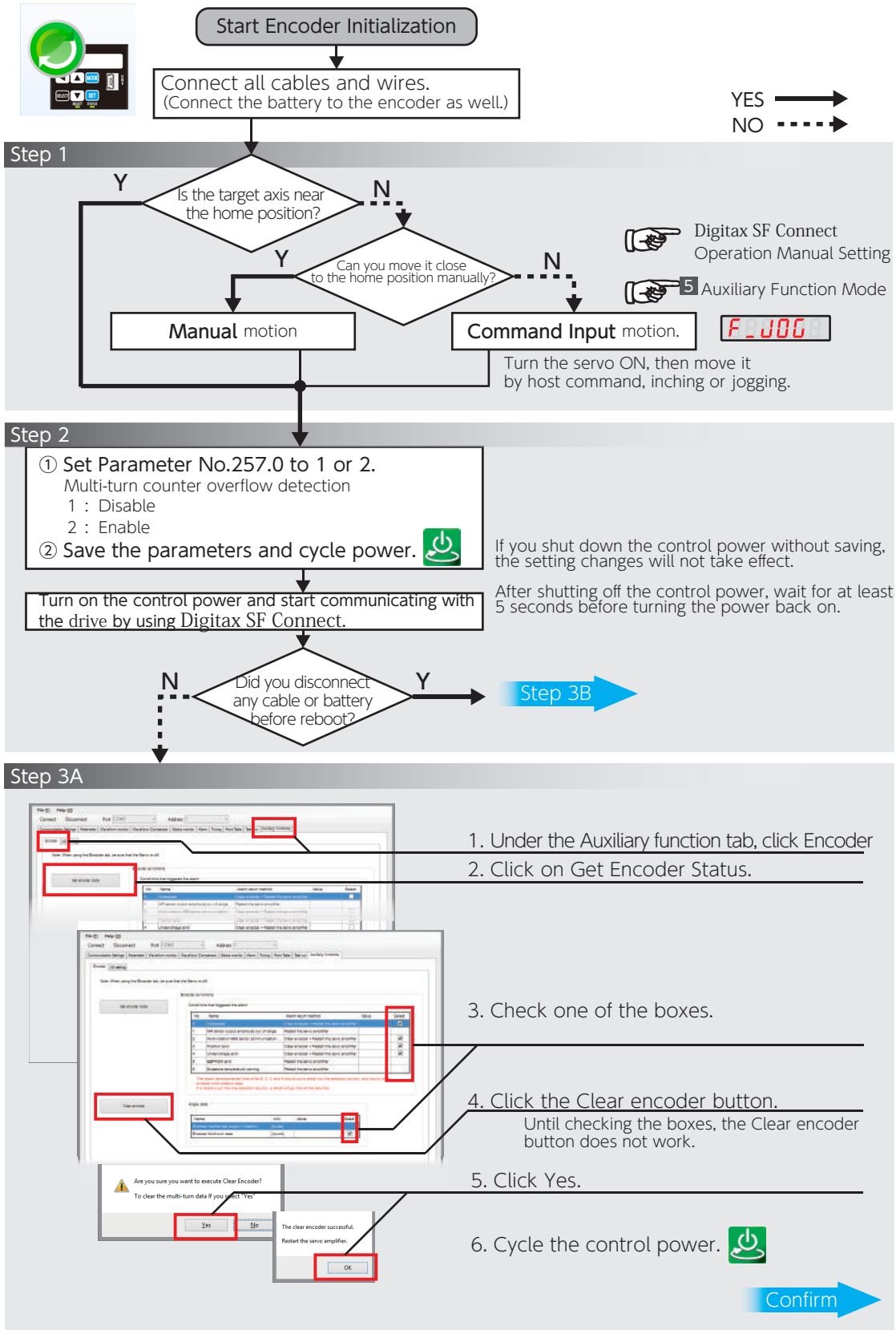

1. Absolute System

Initializing Encoder with Digitax SF Connect (continued)

Step 3B

1. Under the Alarms tab, check the following alarms that are occurring.

- No. 18 Encoder error (circuit)
- No. 20 Encoder error (multi-turn data)
- No. 21 Encoder error (voltage drop)

The Setup Panel on the amplifier displays **Err. 18**.

2. Under the Auxiliary functions tab, select Encoder.

3. Click on Get Encoder Status.

4. Check one of the boxes.

5. Click Clear encoder.

Until checking the boxes, the encoder clear button does not work.

6. Click Yes.

7. Cycle the control power. 

Confirm

Turn on the control power and start communicating with the drive by using Digitax SF Connect.

1. Under the Auxiliary functions tab, select Encoder.

2. Click on Show Encoder Status.

3. Verify that this value is 0.

If an alarm occurs

- ① Check the following.
 - Is the battery connected correctly?
 - Is the battery voltage normal?
 - Is the encoder cable connected correctly?
 - Are the wiring and connections all correct?
- ② Repeat Step 3.

END

1. Absolute System

6. Obtaining Absolute Data

You can check the encoder absolute data using RS-485 Communications or Digitax SF Connect.

Checking Absolute Data using RS-485 Communication

The RS-485 communications enable the host controller to obtain absolute data from the drive. To use RS-485 communications, set the following parameters. Use the Setup Panel or Digitax SF Connect for the parameter setup.

Communications Manual: RS-485

| RS-485 Communications | Parameter No. | Description |
|-----------------------|---------------|--|
| Communication Address | 4.0 | Set the address for RS-485 Communication. The initial value: 1 Range: 1...32 |
| Communication Switch | 8.0 | Enable or disable RS-485 Communication. Select "1" . |
| Minimum response time | 11.0 | Adjust response timing from the drive. Adjust it to satisfy the communication specification of the host controller. The initial value: 3 [ms] Range: 0...255 [ms] |

Example of communication commands to obtain absolute data

Transmit data (*) : **24 01 00 11 00 C3 0A 94**

Response data : **26 01 80 11**

absolute data
an error detection
unit: encoder pulse
segment.
the number of bytes in data: 4 bytes (unsigned)

*) This example is a command sent to the drive at Address 1. If the command is sent to another drive at an address other than Address 1, the error detection segment in the command is different from this example.

Communications Manual: RS-485

Page 26 Encoder/Rotor mechanical angle (integrated value) in List of Status Variables

1. Absolute System

Get Absolute Data by Using Digitax SF Connect

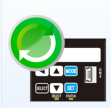

Start Digitax SF Connect and start communicating with the drive.

Use the [Status monitor] tab.

1. Display the Status monitor view.

2. Select Encoder/Rotor mechanical angle (integrated value)
Encoder mechanical angle (integrated value) ... **A**
(=Absolute data)

3. Set the sampling cycle, and then click **Start recording**.
Data capture continues until you click **Stop recording**.

Use the [Auxiliary functions] tab.

1. Under the Auxiliary functions tab, select Encoder.

2. Click on Get Encoder Status.

3. Encoder data is displayed.
Encoder mechanical angle (1 rotation) ... **B**
Encoder Multi-turn data ... **C**

The formula to calculate the absolute data

Below is the formula to derive absolute data (Encoder mechanical angle (integrated value)).

$$\mathbf{A} = \mathbf{B} + \mathbf{C} \times 2^{17}$$

A : Encoder mechanical angle (integrated value)
(=Absolute data)

B : Encoder mechanical angle (1 rotation)

C : Encoder Multi-turn data

1. Absolute System

Alarm

By using Digitax SF Connect, you can check alarms that have occurred when using an absolute system.

These alarms cannot be cleared by Alarm Reset or cycling the control power. To reset alarms, execute ENCODER CLEAR at the Auxiliary functions tab, and then cycle the control power.

1. Click on the Alarms tab.
2. Check the alarms that are occurring.

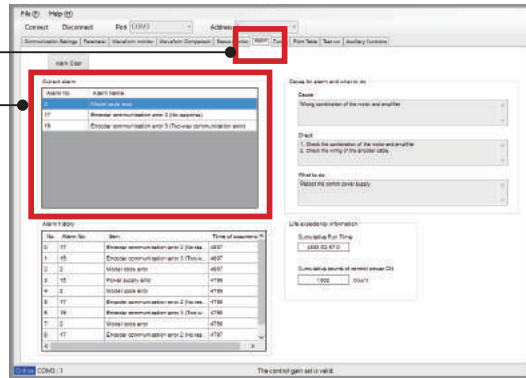
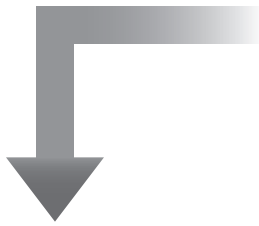

| Alarm No. | Alarm Description | Symptoms and Remedy |
|-----------|---------------------------------------|--|
| 11 | Encoder (multi-turn counter overflow) | <ul style="list-style-type: none"> • Multi-turn data of the encoder has exceeded the specification. • Check the value of Absolute system (257.0). • Verify that rotational data is no higher than 32,767 rotations. |
| 18 | Encoder (circuit) | <ul style="list-style-type: none"> • Anomaly of the encoder itself. • Check the alarm details. |
| 20 | Encoder (multi-turn data) | <ul style="list-style-type: none"> • Multi-turn data being reset. • Check for the encoder cable connection problems such as poor pin contact. • Take noise countermeasures. For example, separate the motor power cable from the encoder cable. |
| 21 | Encoder (voltage drop) | <ul style="list-style-type: none"> • Multi-turn data being reset due to low battery voltage. • Check for low battery voltage and loose connection of the battery cable. • Initialize the encoder. |

Page 14 Encoder Alarms

1. Absolute System

Encoder Alarms

Use Digitax SF Connect to check alarms from the encoder. In case of alarm numbers 18, 20, or 21, you can check the details under the Auxiliary Functions tab in Digitax SF Connect. These alarms cannot be cleared by Alarm Reset or cycle the control power. To reset alarms, execute ENCODER CLEAR, and then cycle the control power. If cycling power does not solve the problem, please contact the supplier

1. Click on the Auxiliary Functions Tab.

2. Check alarms that are occurring.

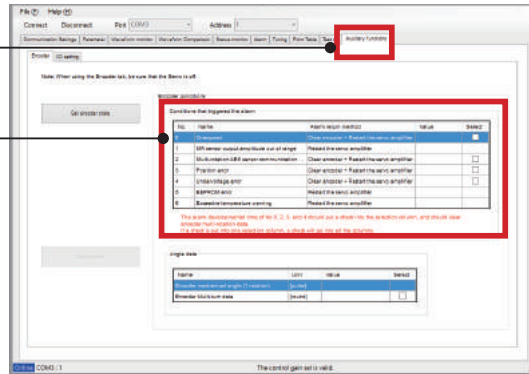

| No. | Name | Description of Symptom |
|-----|---|--|
| 0 | Speed error | Multi-turn sensor error occurred during backup, or speed error occurred upon the control power on. |
| 1 | Angle sensor output Amplitude error | Abnormal amplitude of Angle sensor output amplitude. |
| 2 | Multi-turn ABS sensor communication error | Could not obtain multi-turn data during Initialisation after power up. |
| 3 | Position error | The single-turn sensor value and multi-turn sensor value do not agree because of faulty sensor; the encoder position data is unreliable. |
| 4 | Voltage drop error | Relevant only to absolute encoders. The supply voltage fell below the rated voltage range upon the control power OFF. |
| 5 | EEPROM error | The saved data in EEPROM is corrupted. |
| 6 | Overheat warning | The temperature of the encoder board exceeded the user-specified temperature. |
| 7 | Battery voltage drop warning | The battery voltage (*1) dropped below the user-specified value. |

*1) The battery voltage is checked at the time of power turning on and every hour afterwards. The user-specified voltage is not displayed in Digitax SF Connect.

1. Emergency Stop



When you open User I/O E-STOP, Emergency Stop Status becomes ON.

Servo-OFF triggers deceleration stop and motor motion stops.

No alarm is output.

A warning is output by parameter settings. Close E-STOP to cancel Emergency Stop Status to resume motor operation.

The emergency stop function is always enabled regardless parameter settings; however, you need to set related parameters so that a warning is output upon Emergency Stop Status ON.

| | | |
|---|--|---|
|  | <p>If you close E-STOP to turn Emergency Stop Status off while SVON is being input, any command input immediately starts motor motion.</p> |  |
|---|--|---|

Deceleration Stop Setup

When you open User I/O SVON or E-STOP while operating the motor, the motor makes a deceleration stop according to the method predetermined by parameters.

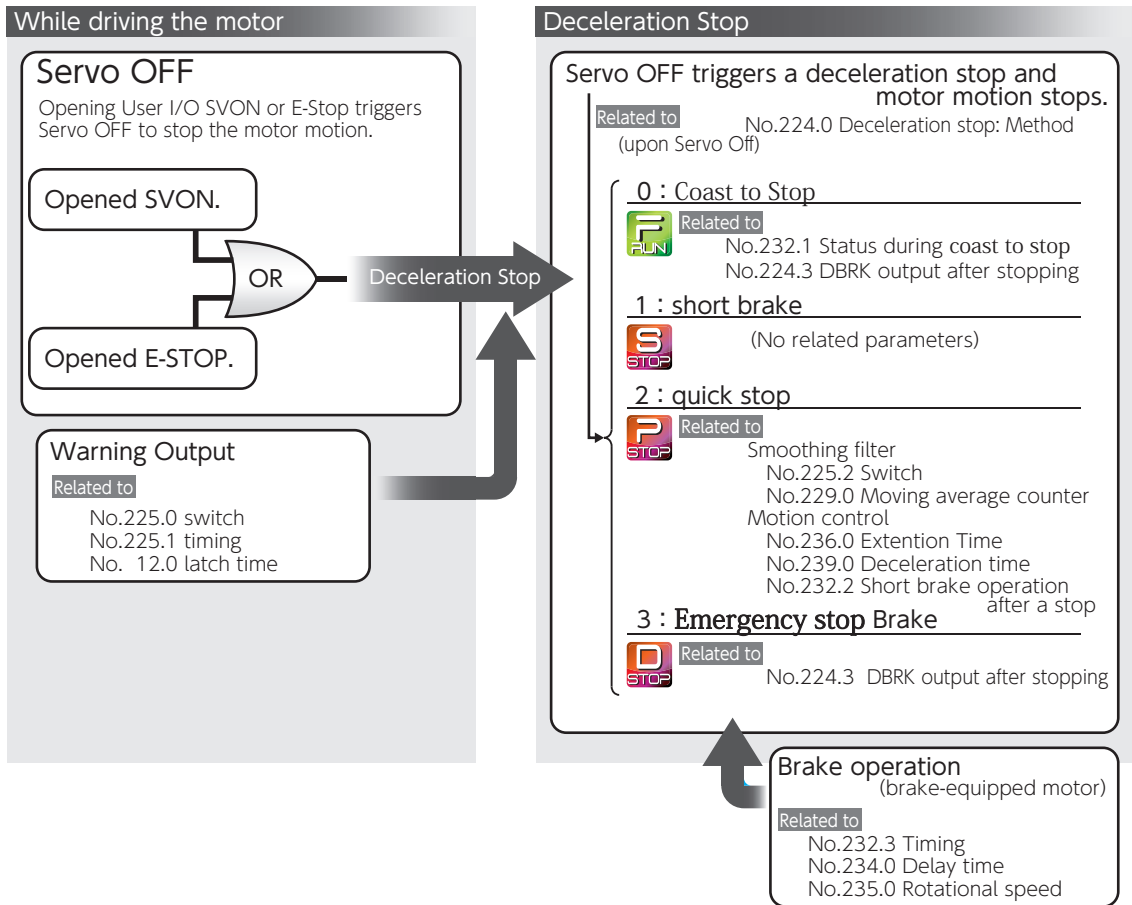

1. Drive Circuit System Block Diagram

Drive

50W 100W 200W 400W 750W 1kW 1.5kW 2kW

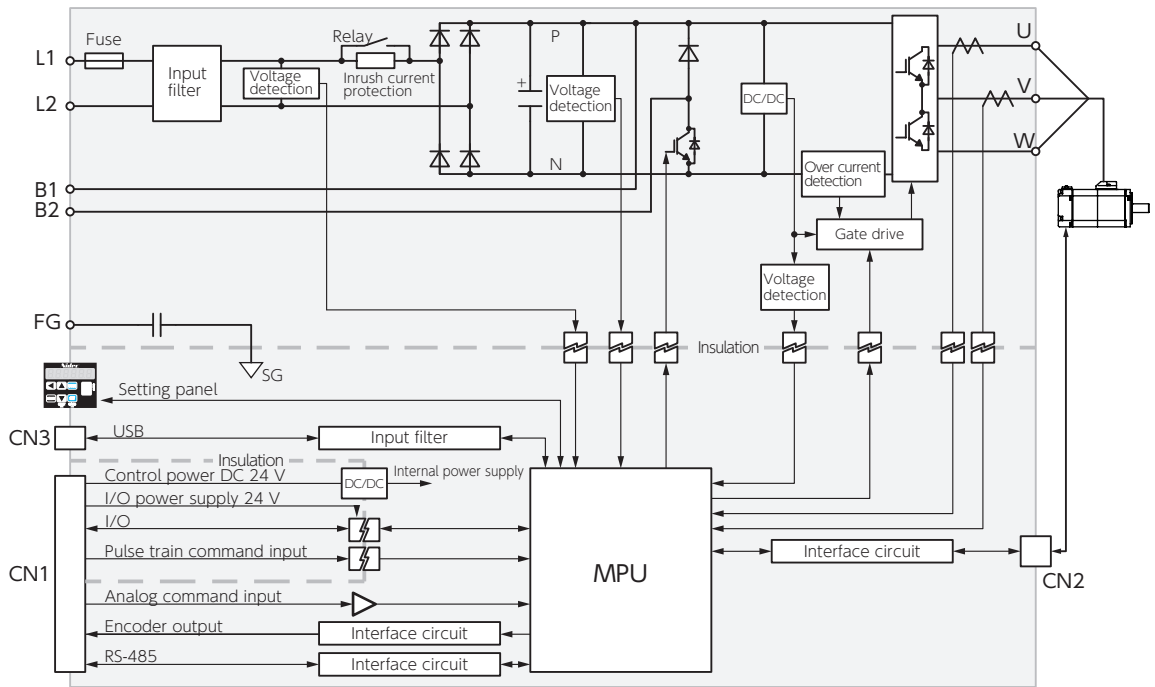

Drive

50W 100W 200W 400W 750W 1kW 1.5kW 2kW

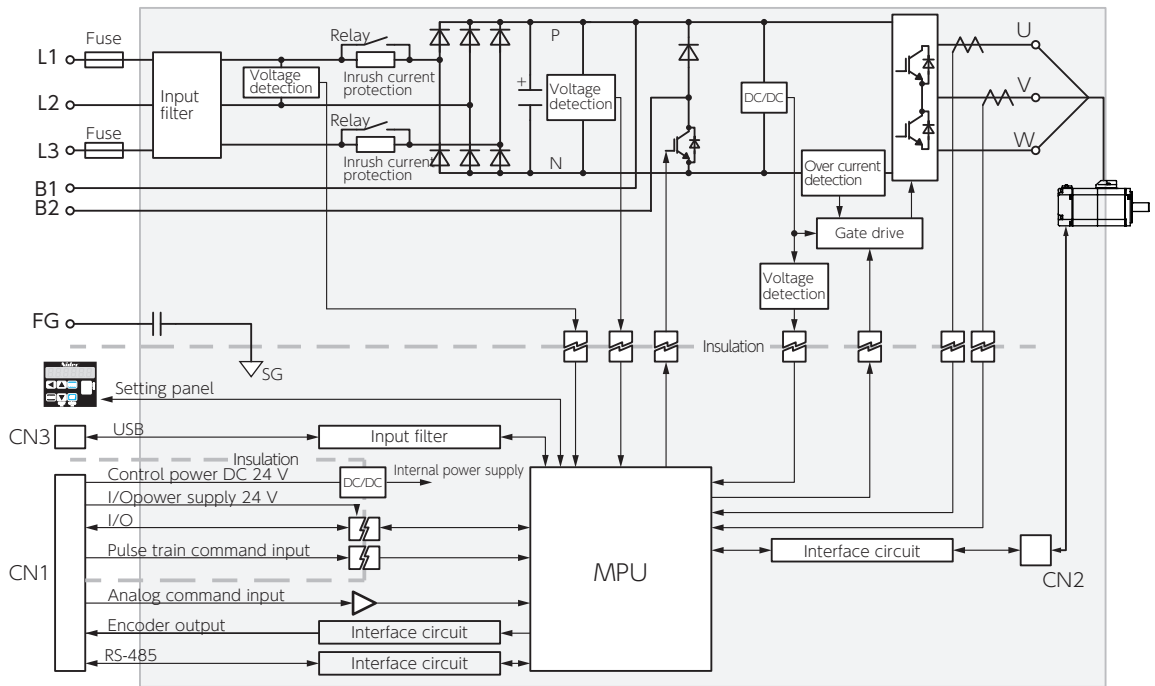

4. Status Display

1. Introduction

You can see status data by using the Setup Panel, Digitax SF Connect or RS-485 communication.

- For information on how to display status information using the Setup Panel or Digitax SF Connect, refer to **5 Settings**

The following communication commands are available for RS-485 communication.

| Command Name | Command Code ^(*) | Description |
|-------------------|-----------------------------|--|
| GET_STATE_VALUE_2 | 10 | The status value specified by a status number is displayed in the <u>2-byte unit</u> . |
| GET_STATE_VALUE_4 | 11 | The status value specified by a status number is displayed in the <u>4-byte unit</u> . |

*) Command code is a hexadecimal number.

 Communications Manual RS-485

The number in the brackets is hexadecimal.

| Status | Alarm | Units | Bytes | Signed |
|---------------------------------|--|-------|-------|--------|
| Status No. (Hexadecimal number) | 0 (00) | - | 4 | no |
| Description | This item indicates the status of the alarm occurring inside of the drive. | | | |
| Transmit data | 24 01 00 11 00 00 E3 BB | | | |

Example of Transmit Command via RS-485 communication
(Example: When sending a command to the drive of Address 1)



The command example is for reference only.

- Be sure to carefully review **5 Settings** and the Communication Manual – RS-485 communication to become familiar with how to use communications commands.
- Be sure that the data to be written is within the range between the predetermined upper limit and lower limit.



Note

This manual uses the following two types of pulse units to explain status variables.

Unit of Encoder pulse

This unit is pulse count of the drive control block, based on the pulses equivalent to single turn of the motor which is 17-bit. It is a pulse value resulting from division/ multiplication in the drive.

Unit of Command pulse

This unit is based on pulse count corresponding to single turn of the motor in the host controller's perspective. This is a pre-division/multiplication value.

4. Status Display

2. List of Status Variables

| Status Variable | Status No. | Units |  |
|--|------------|---|---|
| Alarm | 0 | – | 19 |
| I/O Status | 16 | – | 20 |
| Warning Output | 22 | – | 21 |
| Control Component Temperature | 24 | °C | 21 |
| Pulse Train Command Input (position) | 33 | command pulse | 21 |
| Pulse Train Command Input (speed) | 35 | pulse/160 μ s (50 W to 750 W) pulse/200 μ s (1 kW to 2 kW) | 21 |
| Analog Velocity Command | 49 | rpm | 22 |
| Positioning Status | 64 | – | 22 |
| Internal Command Value | 65 | encoder pulse | 22 |
| Position Feedback | 67 | encoder pulse | 22 |
| Position Error | 69 | encoder pulse | 23 |
| ABS Position Command | 74 | command pulse | 23 |
| Absolute Position Feedback | 76 | command pulse | 24 |
| Command Position Error | 78 | command pulse | 24 |
| ABS Position Error | 80 | command pulse | 24 |
| Speed Command Value | 97 | rpm | 24 |
| Speed Feedback | 98 | rpm | 25 |
| Speed Error | 99 | rpm | 25 |
| Torque Command Value | 113 | 0.1 % | 25 |
| Load Factor | 131 | digit | 26 |
| Load Factor(%) | (*1) 132 | % | 26 |
| Encoder/Rotor mechanical angle (single-turn value) | 194 | encoder pulse | 26 |
| Encoder/Rotor mechanical angle (integrated value) | 195 | encoder pulse | 26 |
| Encoder Temperature | 205 | °C | 26 |
| Encoder Battery Voltage | 206 | 0.1 V | 27 |
| Encoder Communication Retry Count | 216 | times | 27 |
| Encoder Data Error Count | 218 | times | 27 |
| Regeneration Status | 228 | – | 28 |
| AC Supply Voltage | 232 | 0.1 V | 28 |
| Logical I/O Input | (*2) 288 | – | 29 |
| Logical I/O Output | (*2) 296 | – | 30 |
| Inertia Ratio Estimate | 371 | % | 31 |

*1) Digitax SF Connect only

*2) RS-485 communication only

Note: The drive version can be checked in Digitax SF Connect

4. Status Display

3. Details of Each Status Variable

| Status | Alarm | Units | Bytes | Signed |
|------------------------------------|--|-------|---|--------|
| Status No. (Hexadecimal number) | 0 (00) | - |  | no |
| Description | This item indicates the status of the alarm occurring inside of the drive. | | | |
| Transmit data | 24 01 00 11 00 00 E3 BB | | | |

Relations between RS-485 Communication Command and Bit Tables

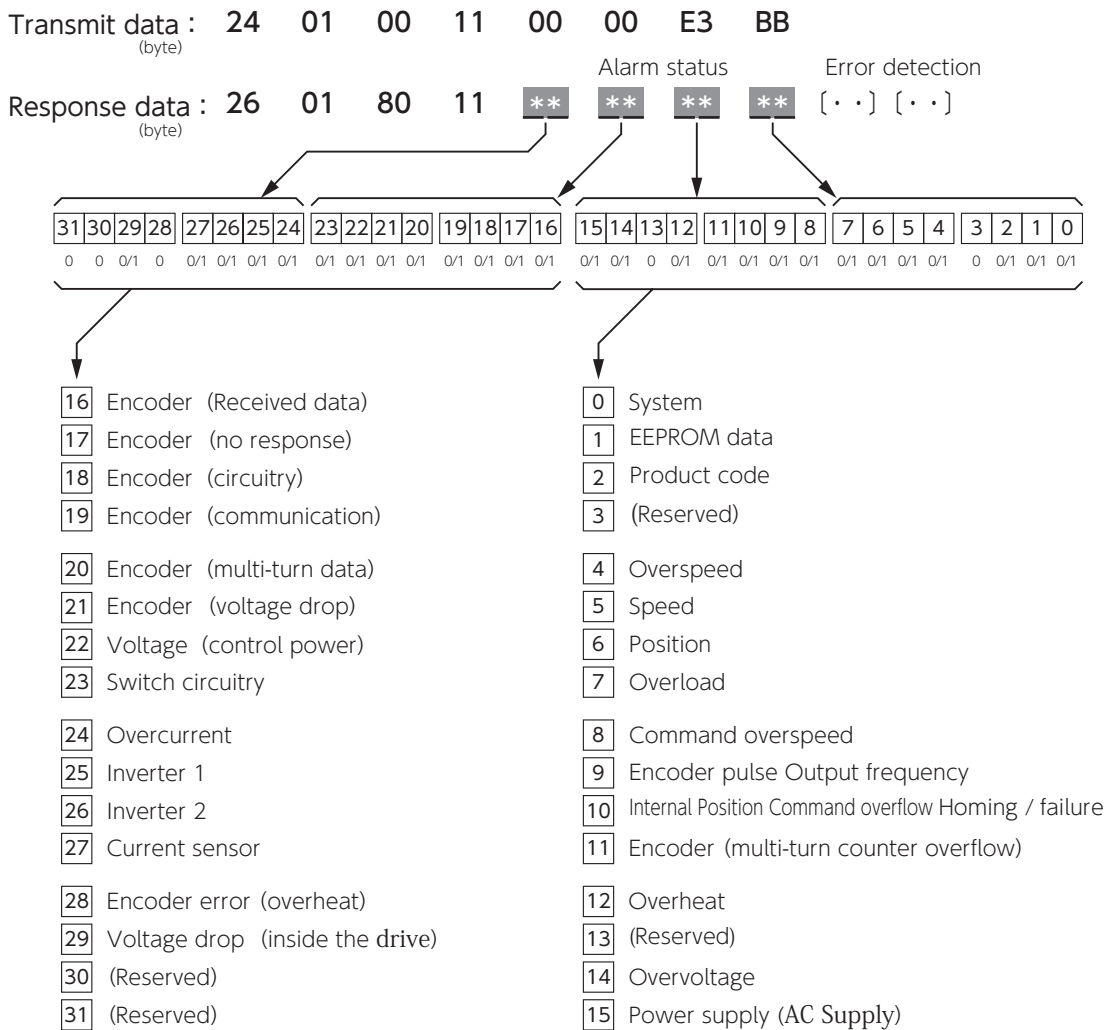

4. Status Display

| Status | I/O Status | Units | Bytes | Signed |
|------------------------------------|--|-------|---|--------|
| Status No. (Hexadecimal number) | 16 (10) | - |  | no |
| Description | This item indicates the I/O Status of the CN1 connector. You can check the I/O Status under 【waveform monitor】 and 【status monitor】 in Digitax SF Connect 【waveform monitor】 · · · displays total value of I/O bits in decimal. 【status monitor】 · · · displays I/O bits in binary. Encoder z-phase output (OCZ) is always fixed to 0. | | | |
| Transmit data | 24 01 00 10 00 10 C6 BA | | | |

Relations between RS-485 Communication Command and Bit Tables

Transmit data : 24 01 00 10 00 10 C6 BA
(byte)

Response data : 24 01 80 10 ** ** Error detection
(byte)

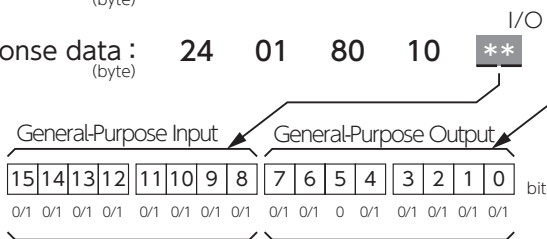

| Control/ Command Mode | Position | | | | | Velocity | | Torque | |
|-----------------------------|-------------|-------------------------|------------------|------------|------------|------------------|------------|------------|--|
| | Pulse Train | | | Internal | | Analog | Internal | Analog | |
| | Preset | Standard | Option 1 | Option 2 | Standard | Option | Standard | Standard | |
| General-Purpose Output | 0 | MRBK | | | PM1 | MRBK | | | |
| | 1 | SERVO | | | PM2 | SERVO | | | |
| | 2 | POSIN | | MEND | PM3 | (Reserved) | | | |
| | 3 | (Reserved) | HEND | WARN1 | HEND | (Reserved) | | | |
| | 4 | T-LIMIT | MEND/ T-LIMIT | T-LIMIT | | MEND/ T-LIMIT | T-LIMIT | | |
| | 5 | OCZ (always fixed to 0) | | | | | | | |
| | 6 | SRDY | DBRK | SRDY | SERVO | SRDY | | | |
| 7 | ALM | | | | | | | | |
| 8 | SVON | | | | | | | | |
| General-Purpose Input | 9 | RESET | | RESET/PCLR | RESET | | | | |
| | 10 | HOLD | | RCSTART1 | HOLD | VCRUN1 | HOLD | | |
| | 11 | PCLR | | PCSEL1 | (Reserved) | VCRUN2 | (Reserved) | | |
| | 12 | (Reserved) | HOME | E-STOP | PCSEL2 | (Reserved) | VCSEL1 | (Reserved) | |
| | 13 | CCWL | | PCSEL3 | CCWL | VCSEL2 | CCWL | | |
| | 14 | CWL | | PCSEL4 | HOME | CWL | VCSEL3 | CWL | |
| | 15 | TLSEL1 | | ORG | TLSEL1 | | | | |

4. Status Display

| | | | | |
|---------------------------------|---|-------|-------|--------|
| Status | Warning Output | Units | Bytes | Signed |
| Status No. (Hexadecimal number) | 22 (16) | - | | no |
| Description | The warning detail is returned in a bit field format. | | | |
| Transmit data | 24 01 00 10 00 16 A6 7C | | | |

Relations between Warning Output and Bit Tables

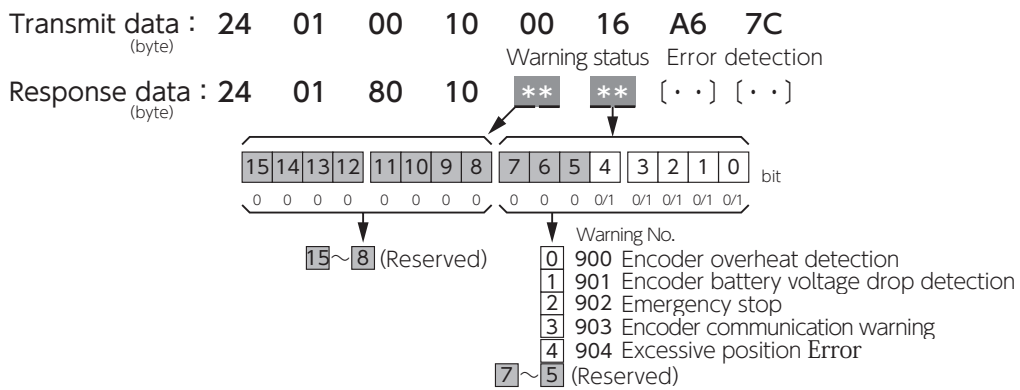



| | | | | |
|---------------------------------|---|-------|-------|--------|
| Status | Control Component Temperature | Units | Bytes | Signed |
| Status No. (Hexadecimal number) | 24 (18) | °C | | yes |
| Description | Indicates the temperature at the drive control block. Install the drive in a place where the temperature at the control block will not exceed 85 °C. | | | |
| Transmit data | 24 01 00 10 00 18 47 B2 | | | |

| | | | | |
|---------------------------------|--|---------------|-------|--------|
| Status | Pulse Train Command Input (position) | Units | Bytes | Signed |
| Status No. (Hexadecimal number) | 33 (21) | command pulse | | yes |
| Description | The pulse count being output from the host controller is returned. | | | |
| Transmit data | 24 01 00 11 00 21 D7 F8 | | | |

| | | | | |
|---------------------------------|---|---|-------|--------|
| Status | Pulse Train Command Input (speed) | Units | Bytes | Signed |
| Status No. (Hexadecimal number) | 35 (23) | pulse/160 μs (750 W or less) pulse/200 μs (1 kW to 2 kW) | | yes |
| Description | The speed value derived from using differentials of Pulse train command (position) at each 160 or 200 μs period is returned. The unit is command pulse. | | | |
| Transmit data | 24 01 00 10 00 23 C0 8A | | | |

4. Status Display

| Status | Analog Velocity Command | Units | Bytes | Signed |
|------------------------------------|---|-------|---|--------|
| Status No. (Hexadecimal number) | 49 (31) | rpm |  | yes |
| Description | Indicates the value of the analog speed command being input to the drive. In Analog Velocity Command mode, by measuring this value (in the waveform data displayed in Digitax SF Connect) and the value of speed error at the same time, you can check the command response and vibration. | | | |
| Transmit data | 24 01 00 10 00 31 F2 F9 | | | |

| Status | Positioning Status | Units | Bytes | Signed |
|------------------------------------|---|-------|---|--------|
| Status No. (Hexadecimal number) | 64 (40) | - |  | no |
| Description | Indicates whether positioning is completed or not 0: Not completed 1: Completed | | | |
| Transmit data | 24 01 00 10 00 40 9C 4F | | | |

| Status | Internal Command Value | Units | Bytes | Signed |
|------------------------------------|---|---------------|---|--------|
| Status No. (Hexadecimal number) | 65 (41) | encoder pulse |  | yes |
| Description | Indicates the command value being input to the position loop. This is a value of the pulse command input (position) or a value of internal position command divided/multiplied and smoothed. | | | |
| Transmit data | 24 01 00 11 00 41 BB 5E | | | |

| Status | Position Feedback | Units | Bytes | Signed |
|------------------------------------|--|---------------|---|--------|
| Status No. (Hexadecimal number) | 67 (43) | encoder pulse |  | yes |
| Description | Indicates the position data of the motor returned from the encoder to the drive. | | | |
| Transmit data | 24 01 00 11 00 43 9B 1C | | | |

4. Status Display

| Status | Position Error | Units | Bytes | Signed |
|------------------------------------|---|---------------|---|--------|
| Status No. (Hexadecimal number) | 69 (45) | encoder pulse |  | yes |
| Description | <p>Indicates error between the position command and position feedback.</p> <p>This value is important for tuning in position control mode, enabling you to do the following: To check the positioning time—for the position error to settle into your desired range after the pulse train command became 0—and vibration. To adjust gains such that the positioning time will be shorter and vibration will be suppressed, so the specifications for the equipment will be satisfied</p> <p>To check resonant frequency, in case of equipment vibration, by using waveforms of position error or torque limit value.</p> <p>To see whether vibration was suppressed by checking waveforms after specifying the vibration frequency for the following position command filters.</p> <ul style="list-style-type: none"> · Filter 1 (Smoothing filter 1) Moving average counter (80.0) · Filter 4 (Smoothing filter 2) Moving average counter (81.0) | | | |
| Transmit data | 24 01 00 11 00 45 FB DA | | | |

| Status | ABS Position Command | Units | Bytes | Signed |
|------------------------------------|--|---------------|---|--------|
| Status No. (Hexadecimal number) | 74 (4A) | command pulse |  | yes |
| Description | This indicates a position command value based on the home-position offset. | | | |
| Transmit data | 24 01 00 11 00 4A 0A 35 | | | |

4. Status Display

| Status | Absolute Position Feedback | Units | Bytes | Signed |
|------------------------------------|--|---------------|---|--------|
| Status No. (Hexadecimal number) | 76 (4C) | command pulse |  | yes |
| Description | Indicates the absolute position data returned from the encoder to the drive. | | | |
| Transmit data | 24 01 00 11 00 4C 6A F3 | | | |

| Status | Command Position Error | Units | Bytes | Signed |
|------------------------------------|--|---------------|---|--------|
| Status No. (Hexadecimal number) | 78 (4E) | command pulse |  | yes |
| Description | Indicates the Error between a position command value and the feed back position value. | | | |
| Transmit data | 24 01 00 11 00 4E 4A B1 | | | |

| Status | ABS Position Error | Units | Bytes | Signed |
|------------------------------------|--|---------------|---|--------|
| Status No. (Hexadecimal number) | 80 (50) | command pulse |  | yes |
| Description | Indicates the Error between a value of ABS Position Command (Status No.74) and the value of ABS Positioning Feedback (Status No.76). | | | |
| Transmit data | 24 01 00 10 00 50 B9 4E | | | |

| Status | Speed Command Value | Units | Bytes | Signed |
|------------------------------------|---|-------|---|--------|
| Status No. (Hexadecimal number) | 97 (61) | rpm |  | yes |
| Description | <p>Indicates the command value being input from the position loop (in Position Control mode) or analog speed command (in Analog Speed Control mode) to the speed loop.</p> <p>While tuning, by measuring this value (waveform data displayed in Digitax SF Connect) and position error (or speed error) at the same time, you can check command response with positioning time and vibration.</p> <p>Verify that no commands with extremely short acceleration/deceleration time are input from the host controller.</p> <p>If a command's acceleration/deceleration time is too short, the motor will be unable to keep up and vibration will easily occur.</p> <p>If you want to set a short acceleration/deceleration time, use a position command smoothing filter.</p> | | | |
| Transmit data | 24 01 00 10 00 61 A8 0C | | | |

4. Status Display

| Status | Speed Feedback | Units | Bytes | Signed |
|------------------------------------|---|-------|---|--------|
| Status No. (Hexadecimal number) | 98 (62) | rpm |  | yes |
| Description | Indicates the speed value returned from the encoder to the drive. With this, you can check command response and motor rotational speed. | | | |
| Transmit data | 24 01 00 10 00 62 98 6F | | | |

| Status | Speed Error | Units | Bytes | Signed |
|------------------------------------|--|-------|---|--------|
| Status No. (Hexadecimal number) | 99 (63) | rpm |  | yes |
| Description | <p>Error between the speed command and the speed feedback.</p> <p>This item is used in Velocity Control Mode. With this, you can check the error during acceleration/deceleration, and adjust gains so that the value becomes within the desired range for the equipment.</p> <p>If the speed error is too large, make the adjustment with Control Gain 1 first, then Integral Gain next.</p> <p>This item is a reference value In Position Control Mode</p> | | | |
| Transmit data | 24 01 00 10 00 63 88 4E | | | |

| Status | Torque Command Value | Units | Bytes | Signed |
|------------------------------------|--|-------|---|--------|
| Status No. (Hexadecimal number) | 113 (71) | 0.1 % |  | yes |
| Description | <p>Indicates the value of torque command. The value of 1,000 equals to the rated torque.</p> <p>You can check the torque range during acceleration time and compare to the rated torque and the instantaneous maximum torque.</p> <ul style="list-style-type: none"> · RMS torque: Keep this below the rated torque. · Instantaneous torque: Use the motor such that this will be approximately 80 % of instantaneous peak torque. <p>When the RMS torque command value reaches the instantaneous max torque value (that is, torque saturation), the torque output will be limited and an alarm will occur after the predetermined time will have elapsed.</p> <p>Torque saturation causes slow response. Take countermeasures.</p> <p>For example,</p> <ol style="list-style-type: none"> ① Set Position command filter. <ul style="list-style-type: none"> · Filter 1 (Smoothing filter 1) Moving average counter (80.0) · Filter 4 (Smoothing filter 2) Moving average counter (81.0) ② Smooth acceleration/deceleration of the command output from the host controller. ③ Install a speed reducer to decrease the inertia ratio. ④ Select a new motor to increase the rotor inertia or increase the capacity to decrease the inertia ratio. | | | |
| Transmit data | 24 01 00 10 00 71 BA 3D | | | |

4. Status Display

| Status | Load Factor | Units | Bytes | Signed |
|------------------------------------|---|-------|---|--------|
| Status No. (Hexadecimal number) | 131 (83) | digit |  | no |
| Description | <p>Indicates the motor load factor. The value of 1,000 is equivalent to 100% of the rated load. This item becoming 1,440 (120%) is an indicator of overload. Adjust the operating conditions such that this value remains under 1,000. Calculation formula : Motor load factor [%] = $\sqrt{\text{Load factor [digit]} \times 10}$</p> | | | |
| Transmit data | 24 01 00 10 00 71 BA 3D | | | |

| Status | Load Factor (%) | Units | Bytes | Signed |
|------------------------------------|--|-------|-------|--------|
| Status No. (Hexadecimal number) | 132 (-) | % | - | no |
| Description | The motor load factor is presented in %. (Digitax SF Connect only) | | | |
| Transmit data | - | | | |

| Status | Encoder/rotor mechanical angle (single-turn value) | Units | Bytes | Signed |
|------------------------------------|--|---------------|---|--------|
| Status No. (Hexadecimal number) | 194 (C2) | encoder pulse |  | no |
| Description | <p>Indicates single-turn data of the motor. It is presented in 0 - 131,072 (17bit). This value is an absolute value.</p> | | | |
| Transmit data | 24 01 00 11 00 C2 1A B5 | | | |

| Status | Encoder/rotor mechanical angle (integrated value) | Units | Bytes | Signed |
|------------------------------------|---|---------------|---|--------|
| Status No. (Hexadecimal number) | 195 (C3) | encoder pulse |  | yes |
| Description | <p>This indicates multi-turn data of the motor. It is presented as a total of encoder feedback pulses. (Single-turn value) + ($2^{17} \times$ Encoder Multi-turn data) This item is the absolute data if you are using an absolute encoder.</p> | | | |
| Transmit data | 24 01 00 11 00 C3 0A 94 | | | |

| Status | Encoder temperature | Units | Bytes | Signed |
|------------------------------------|--|-------|---|--------|
| Status No. (Hexadecimal number) | 205 (CD) | °C |  | yes |
| Description | Indicates the encoder internal temperature. (for reference only) | | | |
| Transmit data | 24 01 00 10 00 CD DC 6A | | | |



4. Status Display

| Status | Encoder battery voltage | Units | Bytes | Signed |
|------------------------------------|--|-------|---|--------|
| Status No. (Hexadecimal number) | 206 (CE) | 0.1 V |  | yes |
| Description | Indicates the voltage of the encoder backup battery. | | | |
| Transmit data | 24 01 00 10 00 CE EC 09 | | | |

| Status | Encoder communication retry times | Units | Bytes | Signed |
|------------------------------------|---|-------|---|--------|
| Status No. (Hexadecimal number) | 216 (D8) | times |  | no |
| Description | Indicates the communication retry count upon encoder communication error. | | | |
| Transmit data | 24 01 00 10 00 D8 9E FE | | | |

| Status | Encoder Data Error Counter | Units | Bytes | Signed |
|------------------------------------|--|-------|---|--------|
| Status No. (Hexadecimal number) | 218 (DA) | times |  | no |
| Description | Indicates the cumulative count of errors in received encoder data. | | | |
| Transmit data | 24 01 00 10 00 DA BE BC | | | |

4. Status Display

| | | | | |
|------------------------------------|--|-------|---|--------|
| Status | Regeneration Status | Units | Bytes | Signed |
| Status No. (Hexadecimal number) | 228 (E4) | - |  | no |
| Description | <p>This item indicates the regeneration status of the . Drive power circuit.</p> <p>Setup Panel</p> <p> 5 Settings Setup Panel</p> <p>Digitax SF Connect</p> <p>【waveform monitor】 displays total value of I/O bits in decimal. 【status monitor】 displays I/O bits in binary.</p> | | | |
| Transmit data | 24 01 00 10 00 E4 69 21 | | | |

Relations between RS-485 Communication Command and Bit Tables

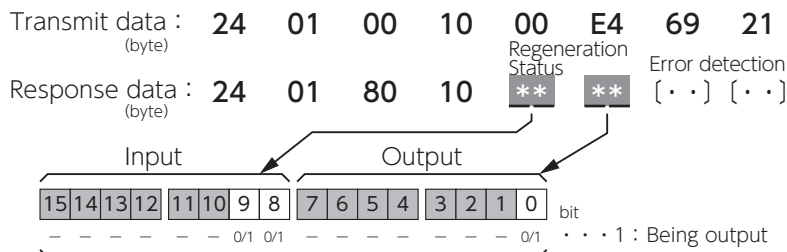

| bit | Name and Meaning | Decimal |
|-----|---|---------|
| 0 | Regeneration control output Indicates the operation status of the regenerative power processing circuit. | 0 |
| 8 | Regeneration voltage warning Indicates the voltage has reached the warning level. You need to connect a braking resistor to the drive. | 256 |
| 9 | Regeneration voltage threshold Indicates the voltage has reached the threshold. A power error, Err. 14 or Err. 15 , will occur if the braking resistor is not connected. | 512 |

| | | | | |
|------------------------------------|--|-------|---|--------|
| Status | Power Circuit Supply Voltage | Units | Bytes | Signed |
| Status No. (Hexadecimal number) | 232 (E8) | 0.1 V |  | no |
| Description | Indicates the power circuit supply voltage (for reference only). | | | |
| Transmit data | 24 01 00 10 00 E8 A8 AD | | | |

4. Status Display

| Status | Logic I/O input | Units | Bytes | Signed |
|------------------------------------|--|-------|---|--------|
| Status No. (Hexadecimal number) | 288 (120) | - |  | no |
| Description | Indicates the logic I/O input status inside the drive. (RS-485 Communication only) Use this item while operating the motor with <u>the point table in Internal Position Command mode</u> using RS-485 communication with the host controller. | | | |
| Transmit data | 24 01 00 11 01 20 F4 E8 | | | |

 Communications Manual RS-485

Relations between Logic I/O input command and Bit Tables

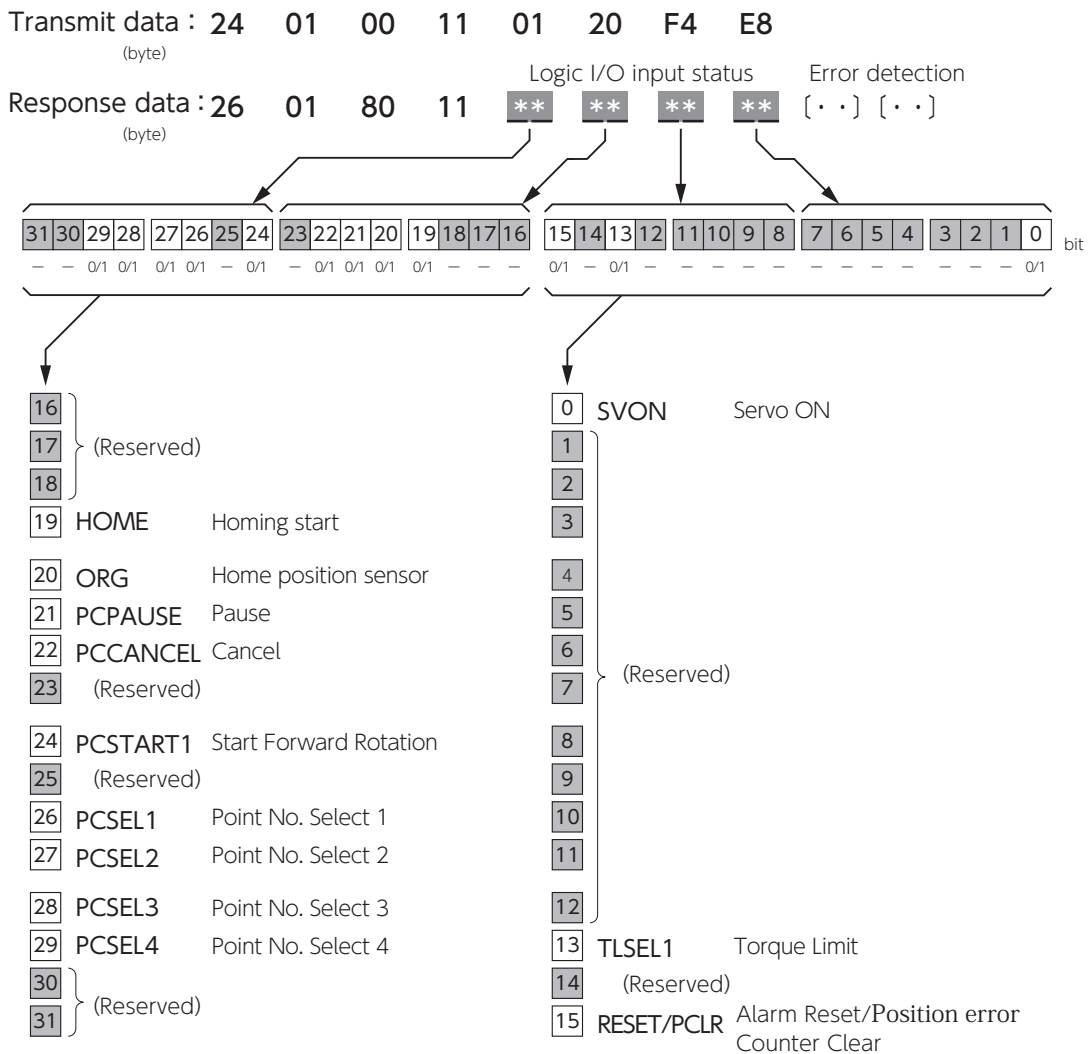

4. Status Display

| Status | Inertia Ratio Estimate | Units | Bytes | Signed |
|------------------------------------|---|-------|--|--------|
| Status No. (Hexadecimal number) | 371 (173) | - |  BYTE | no |
| Description | This item indicates the inertia ratio value estimated in auto tuning. | | | |
| Transmit data | 24 01 00 10 01 73 A9 4E | | | |

5. How to set Pulse train command: Input filter (33.0)

Pulse Train Command Input Filter (No.33.0) is a function to reduce malfunction caused by noise. Select a value for the pulse width that you want the filter to pass Pulse Train Command input signal. Pulse Train Command input is open collector, be sure to select the best filter.

() recommended when input

| Setting | Passing pulse width [ns] | Setting | Passing pulse width [ns] |
|---------|--------------------------|---------|--------------------------|
| 0 | No filter | 8 | 600 (500 kHz) |
| 1 | 25 | 9 | 800 |
| 2 | 50 (4 MHz) | 10 | 1,000 |
| 3 | 100 | 11 | 1,200 |
| 4 | 150 (2 MHz) | 12 | 1,600 (250 kHz) |
| 5 | 200 | 13 | 2,000 |
| 6 | 300 (1 MHz) | 14 | 2,300 |
| 7 | 400 | 15 | 3,100 |

Tip for Filter Setup

- When the input frequency is high, select a small passing pulse width.
- To improve noise resistance, select a larger passing pulse width.

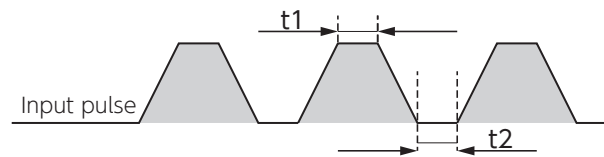

The minimum value of t1 or t2 is the passing pulse width.

- Set the passing pulse width to be 1/3 to 1/2 of the input pulse width.

Example: Input pulse of 2MHz with 50% duty cycle

Because the input pulse width is 250ns, set No.33.0 to 3 or 4 so that pulses to pass the filter will be 125ns or less. (The default is 4)

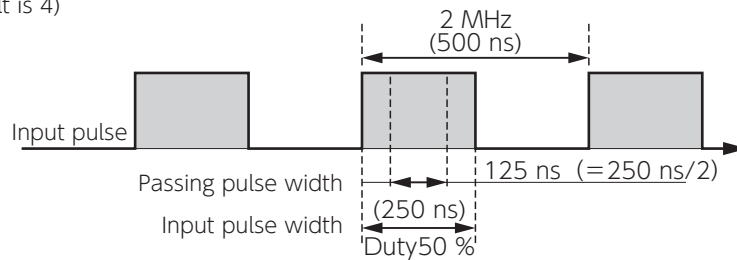

Selecting the best filter value using the pulse frequency by pulse duty cycle matrix

| Pulse Frequency \ Duty [%] | 50 | 40 | 30 | 20 | 10 |
|----------------------------|----|----|----|----|----|
| 100 kHz | 12 | 11 | 10 | 8 | 6 |
| 200 kHz | 9 | 8 | 7 | 6 | 4 |



0478-0606-01